

73070

MENA DEVELOPMENT REPORT

# Renewable Energy Desalination

An Emerging Solution to Close  
the Water Gap in the Middle East  
and North Africa



THE WORLD BANK

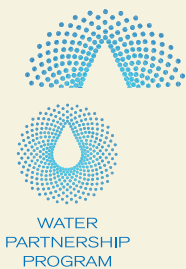

#### **FOR BACKGROUND STUDIES**

The World Bank commissioned multiple intensive background studies that led up to “Renewable Energy Desalination: An Emerging Solution to Close MENA’s Water Gap.” These background studies were summarized in two major reports, also commissioned by the Bank: “MENA Water Outlook to 2050” and the “Use of Desalination and Renewable Energy to Close the Water Demand Gap in MENA.” These reports can be accessed at [www.worldbank.org/mna/watergap](http://www.worldbank.org/mna/watergap)



**THE WORLD BANK**

# Renewable Energy Desalination



MENA DEVELOPMENT REPORT

# Renewable Energy Desalination

An Emerging Solution to  
Close the Water Gap in the  
Middle East and North Africa



**THE WORLD BANK**  
Washington, D.C.

© 2012 International Bank for Reconstruction and Development / The World Bank  
1818 H Street NW, Washington DC 20433  
Telephone: 202-473-1000; Internet: [www.worldbank.org](http://www.worldbank.org)

Some rights reserved  
1 2 3 4 15 14 13 12

This work is a product of the staff of The World Bank with external contributions. Note that The World Bank does not necessarily own each component of the content included in the work. The World Bank therefore does not warrant that the use of the content contained in the work will not infringe on the rights of third parties. The risk of claims resulting from such infringement rests solely with you.

The findings, interpretations, and conclusions expressed in this work do not necessarily reflect the views of The World Bank, its Board of Executive Directors, or the governments they represent. The World Bank does not guarantee the accuracy of the data included in this work. The boundaries, colors, denominations, and other information shown on any map in this work do not imply any judgment on the part of The World Bank concerning the legal status of any territory or the endorsement or acceptance of such boundaries.

Nothing herein shall constitute or be considered to be a limitation upon or waiver of the privileges and immunities of The World Bank, all of which are specifically reserved.

## Rights and Permissions



This work is available under the Creative Commons Attribution 3.0 Unported license (CC BY 3.0) <http://creativecommons.org/licenses/by/3.0>. Under the Creative Commons Attribution license, you are free to copy, distribute, transmit, and adapt this work, including for commercial purposes, under the following conditions:

**Attribution**—Please cite the work as follows: World Bank. 2012. *Renewable Energy Desalination: An Emerging Solution to Close the Water Gap in the Middle East and North Africa*. Washington, DC: World Bank. DOI: 10.1596/978-0-8213-8838-9. License: Creative Commons Attribution CC BY 3.0.

**Translations**—If you create a translation of this work, please add the following disclaimer along with the attribution: *This translation was not created by The World Bank and should not be considered an official World Bank translation. The World Bank shall not be liable for any content or error in this translation.*

All queries on rights and licenses should be addressed to the Office of the Publisher, The World Bank, 1818 H Street NW, Washington, DC 20433, USA; fax: 202-522-2625; e-mail: [pubrights@worldbank.org](mailto:pubrights@worldbank.org).

ISBN (paper): 978-0-8213-8838-9  
ISBN (electronic): 978-0-8213-7980-6  
DOI: 10.1596/978-0-8213-8838-9  
Cover photo: Getty Images, Inc.

## Library of Congress Cataloging-in-Publication Data

Renewable energy desalination : an emerging solution to close the Middle East and North Africa's water gap.

p. cm. — (MENA development report)

Includes bibliographical references.

ISBN 978-0-8213-8838-9 (alk. paper) — ISBN 978-0-8213-9457-1

1. Saline water conversion—Middle East.
2. Saline water conversion—Africa, North.
3. Renewable energy sources—Middle East.
4. Renewable energy sources—Africa, North.

TD478.6.M628R46 2012

628.1'67—dc23

2012020581

# Contents

<b>Foreword</b>	<b>xiii</b>
<b>Acknowledgments</b>	<b>xv</b>
<b>Abbreviations</b>	<b>xix</b>
<b>Overview</b>	<b>1</b>
<b>1. Introduction</b>	<b>19</b>
Origin and Purpose of This Study	20
Chapter Summaries	22
Note	24
References	24
<b>2. MENA's Water Gap Will Grow Fivefold by 2050</b>	<b>25</b>
Water Availability and Demand	26
MENA's Current Water Balance: Already in the Red	28
Climate Change Threatens MENA's Future Water Availability	29
MENA's Future Water Demand: Population and GDP Factor	31
Future Water Balance: The Gap Grows	34
Imperative for Demand and Supply Management	36
Notes	43
References	44
<b>3. Closing MENA's Water Gap Is Costly and Challenging</b>	<b>45</b>
Strategic Approach	46
Unit Costs of Tactical Options	48
Alleviating the Demand Gap	50
Phasing of Tactical Options Strongly Influenced by Sunk	
Investment	54
Transition from Conventional to CSP Desalination	55

Phasing the Tactical Options	56
Costs of Adaptation Measures	56
Notes	59
References	60
<b>4. Desalination in MENA and Its Energy Implications</b>	<b>63</b>
Growth of Desalination in MENA and Associated Challenges	65
Future Trends in Desalination	69
Desalination Will Increase MENA's Energy Demand	74
Can Energy Intensity of Desalination Be Reduced?	76
MENA's Renewable Energy Potential	77
Notes	84
References	84
<b>5. Potential for Renewable Energy Desalination</b>	<b>87</b>
Factors Affecting Renewable Energy Desalination Linkages	87
CSP and Desalination Plant Design Considerations	93
Innovation and Scaling-Up Will Reduce Costs	105
Notes	108
References	109
<b>6. Environmental Impacts of Desalination</b>	<b>111</b>
Desalination: Atmospheric Pollution	111
Desalination: Marine Pollution	112
Desalination-Brine Disposal Options	115
Necessity for Environmental Impact Assessment	122
Regional Policy and Regulatory Frameworks Are Needed	122
Notes	124
References	124
<b>7. CSP Desalination and Regional Energy Initiatives</b>	<b>127</b>
Energy Consumption in MENA	128
Managing Barriers to Renewable Energy-Based Desalination	131
Notes	139
References	139
<b>8. Conclusions</b>	<b>141</b>
MENA's Water Scarcity Is Bound to Grow	141
MENA Increasingly Will Rely on Desalination	142
Solar Energy Is MENA's Abundant Renewable Resource	142
Costs of Inaction Will Be High	143
The Solutions Are at Hand	144
Next Steps	144
Note	145



<b>Appendix A Water Demand and Supply in MENA Region</b>	<b>147</b>
Climate Change Will Affect MENA’s Future Water Supply	148
Current and Future Water Demand	157
Notes	166
References	168
<b>Appendix B Imperative for Demand and Supply Management</b>	<b>169</b>
Improving Institutions	169
Demand Management	172
Conventional Supply Management Options Are Limited	181
Notes	185
References	186
<b>Appendix C The True Cost of Desalination</b>	<b>189</b>
Notes	197
References	197
<b>Appendix D Summary of Renewable Energy Policies and Legislation in MENA</b>	<b>199</b>
Notes	206
Reference	208
<b>Boxes</b>	
4.1 Desalination Is a Possible Option for Sana’a, The Republic of Yemen, but Transport Costs Could Be Prohibitive	73
5.1 GemaSolar Central Receiver Plant Project, Fuentes de Andalucía, Spain	92
6.1 Cutting Environmental Management Costs: Brine Harvesting	122
7.1 How Increased Energy Intensity Can Lead to Overall Energy Savings	130
B.1 Priorities for Reducing Nonrevenue Water	180
B.2 Recycled Water Is a Valuable Resource: Examples from Kuwait and Tunisia	184
<b>Figures</b>	
O.1 Sources of New Water Supplies by 2050	8
O.2 Distribution of Worldwide Desalination Capacity, 2007	9
O.3 Electricity Cost of Concentrating Solar Power Plants Compared to Specific Cost of Peak-, Medium-, and Baseload Plants (Annualized Costs)	14
2.1 Water Resources Availability and Use in MENA Countries	28

2.2	Predicted Water Availability in the MENA Region, 2010–50	30
2.3	Relation between per Capita Domestic Water Withdrawals and GDP per Capita	32
2.4	Value of Groundwater Depletion in Selected MENA Countries as a Share of GDP	37
2.5	High-Tech Agricultural Packages Increase Water Use Efficiency	39
2.6	Cost Range for Water Reuse	42
3.1	Schematic Representation of Marginal Water Cost Curve	47
3.2	Desalination Will Play a Significant Role in Closing the Water Demand Gap in Most MENA Countries by 2040–50	52
3.3	Ranking and Magnitude of Tactical Options to Fill the Water Gap by 2050 Vary Considerably by Country	53
3.4	Typical Desalination Plant Life Curves, 2010–50	55
3.5	Maximum Annual Capacity Additions for CSP Desalination Plants in MENA	56
3.6	Cost-Optimized Pattern of Future Water Supply for MENA under the “Average” Climate Change Scenario, 2000–50	57
4.1	Distribution of Worldwide Desalination Capacity, 2007	64
4.2	Share of National Water Demand in MENA Met by Desalination, 2010	64
4.3	Growth of On-Line Desalination Capacity in MENA, 1950–2010	67
4.4	Forecast of Annual Global Growth of Desalination by Technology, 2006–16	69
4.5	MENA Prominent among Top 15 Desalination Markets, 2007–16	70
4.6	Components of Total Annual Desalination Costs	76
4.7	Reduction in MSF Desalination Cost, 1955–2005	77
4.8	Reduction in RO Power Consumption, 1970–2010	77
5.1	Global Renewable Energy Desalination by Energy Source, 2009	88
5.2	Renewable Energy Production from Photovoltaics, Wind, and Concentrating Solar Power at Hurghada Site, Egypt	90
5.3	Storage System in a Trough Solar Plant	94
5.4	Different Configurations of CSP Thermal Storage	95
5.5	Linear Fresnel Collector, Plataforma Solar de Almeria, Spain	97
5.6	Linking the Choice of Solar Collection System to Power Generation and Desalination	98

5.7	Typical Configurations of CSP Desalination by the Type of Renewable Energy	100
5.8	CSP Desalination Plant Configurations	101
5.9	Levelized Water Production Costs by Plant Type and Location	104
5.10	Electricity Cost of Concentrating Solar Power Plants Compared to Specific Cost of Peak-, Medium-, and Baseload Plants	106
5.11	Phased Market Introduction of CSP, 2010–50	107
6.1	Scale-Dependent Capital Costs of Concentrate Disposal Options	121
7.1	Stages of Energy Use in Water Supply, Distribution, and Use	130
A.1	Five-Year Moving Averages of Projected Precipitation, Temperature, and Potential Evapotranspiration for Morocco and the United Arab Emirates, 2010–50	150
A.2	Wide Range of Average Annual Precipitation among MENA Countries, 2000–09	153
A.3	Predicted Water Availability in the MENA Region, 2010–50	155
A.4	Relation between per Capita Domestic Water Withdrawals and GDP	158
A.5	Global Comparisons of per Capita Domestic Water Demand	159
A.6	Balance of Demand and Supply in MENA under Average Climate Change Scenario, 2000–50	163
A.7	Balance of Demand and Supply in MENA under Dry Climate Change Scenario, 2000–50	163
A.8	Large Water Demand Gap in MENA Countries under Average Climate Change Scenario, 2000–50	164
A.9	Assessment of Individual Countries	164
B.1	High-Tech Agricultural Packages Increase Water Use Efficiency	174
B.2	Value of Groundwater Depletion in Selected MENA Countries as Share of GDP	178
B.3	Nonrevenue Water Rates for Utilities in Selected MENA Countries and Cities	179
B.4	Cost Range for Water Reuse	185
<b>Maps</b>		
2.1	Declining per Capita Water Availability: A Growing Threat in MENA	27
2.2	Predicted Changes in Water Availability in the MENA Region, 2010–50	31

2.3	Distribution of MENA Areas Equipped for Irrigation, 2000	33
4.1	Gross Hydropower Potential	78
4.2	Annual Average Wind Speed at 80 m above Ground (m/sec)	79
4.3	Annual Sum of Direct Normal Irradiation, 2011	81
4.4	Concentrating Solar Power Potential in the MENA Region, 2011	82
6.1	Desalination in the Gulf and Its Environmental Impacts, 2007	113
A.1	Declining per Capita Water Availability: A Growing Threat in MENA	149
A.2	Projected Changes in Precipitation across MENA, 2010–50	152
A.3	Predicted Changes in Water Availability in the MENA Region, 2010–50	156
A.4	Distribution of MENA Areas Equipped for Irrigation, 2009	160
B.1	United Arab Emirates Groundwater Resources Are Large but Mostly Brackish	182

### Tables

O.1	MENA Annual Water Demand and Supply under Average Climate Change Scenario, 2000–50	4
O.2	Total Annualized Cost of Desalinated Seawater	11
O.3	Levelized Costs of Electricity of CSP and Other Technologies	14
O.4	Total Annualized Cost of RE-Desalinated Seawater	14
2.1	MENA Annual Water Demand and Supply under Average Climate Change Scenario, 2000–50	25
2.2	MENA Irrigation Water Demand	34
2.3	MENA Water Demand Gap under Three Climate Scenarios, 2000–50	34
2.4	Current and Future Water Demand and Unmet Demand Gap under the Average Climate Change Projection	35
3.1	Effect of Tactical Options under the Average Climate Scenario to Reduce MENA Water Demand Gap by 2040–50	51
3.2	Adaptation Costs by Country Ranked by Costs per Capita	58
4.1	Efficiency of Converting Saline to Fresh Water and Brine Effluents	67
4.2	Summary Characteristics of Various Commercial Desalination Technologies	68
4.3	Seawater Characteristics Vary Widely in MENA	70
4.4	Typical Capital Investment Costs of Desalinated Seawater	72
4.5	Typical Operational Costs of Desalinated Seawater	73

4.6	Total Annualized Cost of Desalinated Seawater	74
4.7	Estimated Installed Capacity and Primary Energy Use for Desalination in Selected MENA Countries, 2003–10	75
4.8	Estimated Renewable Electricity Potential for MENA Countries	83
4.9	LECs of CSP and Other Technologies	83
5.1	Costs of Desalinated Seawater from Renewable Energy Alternatives	89
5.2	Comparison of Principal Features of Solar Thermal Storage Technologies	91
5.3	Annual Full Load Hours of CSP Plant for Different Solar Multiple, Latitude, and Level of Annual Direct Normal Irradiance	96
5.4	Comparison of Concentrating Solar Power Collecting Systems	99
5.5	Main Financial Assumptions for CSP Desal CAPEX and OPEX Calculation	102
5.6	Capital Costs of Two Main CSP Desalination Configuration Options	103
6.1	Disposal of Incremental Volume of Brines from Desalination by 2050	112
6.2	Environmental Requirements for Desalination	116
6.3	Challenges of Brine Disposal	120
6.4	Cost Comparison of Brine Concentrate Disposal	120
7.1	Estimated MENA Electricity Generation, Installed Capacity, and CO <sub>2</sub> Emissions, 2010	128
7.2	Barriers to RE Desalination in MENA	132
A.1	MENA Water Demand and Supply, 2000–50	147
A.2	MENA Irrigation Water Demand	161
A.3	MENA Water Demand Gap under Three Climate Scenarios, 2000–50	162
A.4	Current and Future Water Demand and Unmet Demand Gap under the Average Climate Projection (MCM)	165
B.1	Saudi Arabia’s 2009 Draft National Water Strategy Promotes Far-Reaching Water Management Reforms	171
C.1	Subsidized Electricity Costs: Morocco and Saudi Arabia	189
C.2	Nonsubsidized Energy Cost	189
C.3	Subsidized and Nonsubsidized Steam Price	190
C.4	Preliminary Analysis Results: Investment Cost Breakdown and LEC, Heavy Fuel Oil	191
C.5	Preliminary Analysis Results: Investment Cost Breakdown and LEC, Natural Gas	193

---

C.6 CAPEX Cost Estimate of Typical SWRO Plant 100,000 m <sup>3</sup> per day Comprising Pretreatment of FF1	195
C.7 OPEX Cost Estimation of Typical MED Plant	196
D.1 Status of Renewable Energy Policies and Legislation in MENA	201

## Foreword

The Middle East and North Africa (MENA) region is one of the most water-stressed parts of the world. In just over 25 years, between 1975 and 2001, the amount of fresh water available to a citizen of MENA was cut in half—from 3,000 m<sup>3</sup>/capita to 1,500m<sup>3</sup>/capita—largely due to rapid population growth. Today, that citizen has a little over 1,000 m<sup>3</sup> for her use, compared to a global average of over 7,000 m<sup>3</sup>. By another measure, 14 of the world's top 20 water-scarce countries are in MENA.

Looking to the future, MENA's freshwater outlook is expected to worsen because of continued population growth and projected climate change impacts. The region's population is on the way to doubling to 700 million by 2050. Projections of climate change and variability impacts on the region's water availability are highly uncertain, but they are expected to be largely negative. To offer just one more example, rainfall and freshwater availability could decrease by up to 40 percent for some MENA countries by the end of this century.

The urgent challenge is how to adapt to the future as illustrated by these numbers and how to turn the region's economy onto a sustainable path. This volume suggests new ways of thinking about the complex changes and planning needed to achieve this. New thinking will mean making better use of desert land, sun, and salt water—the abundant riches of the region—which can be harnessed to underpin sustainable growth. More mundane, but just as important, new thinking will also mean planning for dramatically better management of the water already available.

Right now, water is very poorly managed in MENA. Inefficiencies are notorious in agriculture, where irrigation consumes up to 81 percent of extracted water. Similarly, municipal and industrial water supply systems have abnormally high losses, and most utilities are financially unsustainable. In addition, many MENA countries overexploit their fossil aquifers to meet growing water demand. None of this is sustainable while water resources decline.

To meet rising water demand, desalination is on the rise in MENA countries, but it is costly and energy intensive and further strains the environment with brine disposal and greenhouse gas (GHG) emissions.

Countries in the region recognize these challenges. They recognize that both inefficient use of water resources and remedies such as fossil-fueled desalination are not sustainable. They also recognize that, on current trends, they will lose their global leadership in energy and with that the significant revenue stream from petroleum products. So countries are working to improve water use efficiencies and increasingly building renewable energy alternatives as an additional source of power. Worth applauding is the fact that MENA countries are planning to increase the share of renewables in their energy portfolio mixes by 5 to 40 percent by 2030. And the region is already a global leader in both desalination and renewable energy technologies, mainly in solar. Yet, in the face of the sheer scale of the challenges, more needs to be done.

This volume hopes to add to the ongoing thinking and planning by presenting methodologies to address the water demand gap. It assesses the viability of desalination powered by renewable energy from economic, social, technical, and environmental viewpoints, and it reviews initiatives attempting to make renewable energy desalination a competitively viable option.

The authors also highlight the change required in terms of policy, financing, and regional cooperation to make this alternative method of desalination a success. And as with any leading edge technology, the conversation here is of course about scale, cost, environmental impact, and—where countries share water bodies—plain good neighborly behavior.

I commend the efforts of the authors and hope this publication will contribute to the ongoing debate about green growth in the MENA region while building a realistic picture of green job creation for many young people in the region.



Inger Andersen  
Vice President  
Middle East and North Africa Region  
The World Bank



# Acknowledgments

This volume is the outcome of multiple intensive studies on water and energy in the Middle East and North Africa Region commissioned by the World Bank over the last two years. The leadership, support, and guidance provided by Bank managers were essential to the progress of this work. The task team wishes to thank particularly Francis Ato Brown (Water Sector Manager, MNSSD), Jonathan Walters (former Sector Manager for Energy and Transport, MNSSD; now Director, Regional Strategy and Programs), Laszlo Lovei (former Sector Director, MNSSD), and Junaid Kamal Ahmad (Sector Director, MNSSD). Their strong support for the idea of conducting the series of studies on MENA's water future and fully funding these studies was critical.

Written comments and guidance provided by the country directors and country managers also are highly appreciated. In particular, the task team thanks Benson Ateng (Country Manager, the Republic of Yemen), A. David Craig (Country Director, the Arab Republic of Egypt, the Republic of Yemen, and Djibouti), Simon Gray (Country Director, Algeria, Morocco, and Tunisia), Farrukh Iqbal (Country Director, Gulf Cooperation Council Countries), Eavan O'Halloran (Country Program Coordinator, Morocco), Mariam Sherman (Country Director, West Bank and Gaza), and Moukim Temourov (Country Manager, Algeria).

The task team also wishes to thank the governments of all 21 MENA countries included in this volume for their interest in participating in the study and for sharing necessary information as requested. The task team thanks particularly the Governments of Algeria, the Arab Republic of Egypt, Morocco, Oman, Saudi Arabia, and the Republic of Yemen for taking active roles in the study and for logistically supporting some workshops in their countries.

This volume has benefited greatly from the active participation, guidance, and comments provided by various governments and academic and policy think tanks that focus on water and energy security in the MENA

Region. Written comments provided by counterparts from Algeria, the Arab Republic of Egypt, Jordan, Lebanon, Morocco, Oman, Qatar, Saudi Arabia, and the Republic of Yemen are highly appreciated.

The team also thanks the Middle East Desalination Research Center (MEDRC) based in Muscat, Oman, and its energetic staff, particularly Shannon McCarty (Deputy Director) and Ambassador Ronald Mollinger (Director), for hosting the first regional consultation, held November 22–23, 2010. The draft report of this volume has been shared at the 2nd Arab Water Forum, held in Cairo November 20–23, 2011. Critical comments received during and after the forum have improved greatly the quality of the report, and the task team gives thanks to all who took the time to write them.

This volume also benefited greatly from reviews and critical comments provided by many colleagues inside and outside the Bank during the course of the studies. The task team thanks them for their valuable comments and guidance, which enriched the content. For their accessibility, guidance, and encouragement during this effort, the team is grateful to Heba Yaken Aref Ahmed (World Bank), Samia Al-Duaij (World Bank), Maher Alodan (KA-CARE, Saudi Arabia), Waleed Alsuraih (World Bank), Alexander Bakalian (World Bank), Caroline van den Berg (World Bank), Jimmy Bisese (RTI International), Roger Coma Cuncil (World Bank), David Furukawa (Chief Scientific Officer, National Center of Excellence in Desalination, Australia), Mohab Awad Mokhtar Hallouda (World Bank), Yoshiharu Kobayashi (World Bank), Hassan Lamrani (World Bank), Sabine Lattemann (previously at the University of Oldenburg; now at the Water Desalination and Reuse Center, King Abdullah University of Science and Technology, or KAUST, in Saudi Arabia), Tobias Marz (Mercator Fellow), Nachida Merzouk (Algerian Centre for Renewable Energy Development, or CDER), Fekadu Moreda (RTI International), Silvia Martinez Romero (World Bank), Hani Abdel-Kader El Sadani Salem (World Bank), John Tonner (previously at Water Consultants International; now at Consolidated Water Co., Ltd.), Vladislav Vucetic (World Bank), and Marcus Wijnen (World Bank). The team is especially grateful to Sabine Lattemann and John Tonner for their detailed comments and guidance on the environmental implications of desalination, and desalination and renewable energy, respectively.

The internal peer reviewers were Nagaraja Rao Harshadeep (Senior Environmental Specialist, AFTEN), Fernanda Zermoglio (Climate Change Scientist, ENV), Nataliya Kulichenko (Senior Energy Specialist, SEGEN), Julia Bucknall (Sector Manager, TWIWA), Khairy Al-Jamal (Senior Infrastructure Specialist, EASIS), Jeffrey Delmon (Senior Infrastructure Specialist, FEUFS), and Hocine Chalal (Safeguards Adviser).

The task team thanks them for all of their hard work and useful comments and guidance throughout.

The volume was prepared by the team led by Bekele Debele Negewo. The core team included Chandrasekar Govindarajalu, George Keith Pitman, Richard Hosier, and Kristen Huttner, supported by Leila Ezzarqui, Fowzia Hassan, Magalie Pradel, Georgine Seydi, Etayenesh Asfaw, and Azeb Yideru. Walter Immerzeel and others (from Future Water) authored the background report on water availability and water demand assessment in MENA, including climate change impacts and costing the various water supply options. Fulya Verdier and others (from Fichtner and Co.) wrote the background reports on desalination and environmental implications of scaled-up desalination in the region's shared waterbodies. Franz Trieb and others (from DLR) authored the background report on renewable energy potential in MENA and the use of concentrating solar power (CSP) in desalination. This volume also relies in part on previous studies commissioned by the Bank, such as *Making the Most of Scarcity* (2007), and others in the water and energy sectors in MENA, and other regional reports.

The team wishes also to acknowledge the hard work and support provided by the production team: Alicia Hetzner for her initial editing of the chapters; Stuart Tucker, Rick Ludwick, and Paola Scalabrin, EXTOP, for their all too kind guidance and support regarding communications; and Debra Naylor for her design skills. The team also expresses appreciation to Jeffrey Lecksell, GSD Map Design Unit; Hector Hernaez, Heba Refaay, and Ahmad Omar, GSD Translation and Interpretation team; and Adrian Feil, GSD Printing and Graphics Unit, for their skills and collaboration.

This initiative was supported in part by the World Bank's Water Partnership Program (WPP) financed by the Multi-Donor Trust Fund and the Bank's Energy Sector Management Assistance Program (ESMAP); and through the Multi-Donor Trust Fund for Addressing Climate Change in the Middle East and North Africa (MENA) Region, supported by the European Commission and Italy's Ministry of Foreign Affairs. Their generous support is gratefully acknowledged.



# Abbreviations

Abs	Absolute
AC	Alternating current
ADB	Asian Development Bank
AEO	Annual Energy Outlook
AQUASTAT	FAO's Annual Water and agriculture GIS statistics (FAO)
AR4	Fourth Assessment Report
AT2050	"Agriculture Towards 2050" (FAO)
AWC	Arab Water Council
BaU	Business as usual
bbl	Barrel (petroleum product)
BCM	Billion cubic meters
BOO	Build own operate
BOOT	Build own operate transfer
CAPEX	Capital expenditure
CCGT	Combined-cycle gas turbine
CCPP	Combined-cycle power plant
CIESIN	Center for International Earth Science Information Network (U.S.)
CO <sub>2</sub>	Carbon dioxide
CPWC	Cooperative Programme on Water and Climate (The Netherlands)
CSP	Concentrating solar power
CSP-MED	Concentrating solar power-multiple effect distillation
CSP-RO	Concentrating solar power-reverse osmosis
CTF	Clean Technology Fund
DAF	Dissolved air flotation
DLR	<i>Deutsches Zentrum für Luft und Raumfahrt</i> (German Aerospace Center)
DNI	Direct normal irradiance

DO	Dissolved oxygen
DOE	Department of Energy (U.S.)
doi	Digital object identifier
DSM	Demand-side management
EC	European Commission
ECA	Europe and Central Asia
ECMWF	European Centre for Medium-Range Weather Forecasts
EDR	Electrodialysis reversal
EIA	Environmental impact assessment; U.S. Energy Information Administration
EIR	Environmental impact report
ESMAP	Energy Sector Management Assistance Program
ET	Evapotranspiration
ET <sub>o</sub>	Reference evapotranspiration
EU	European Union
FAO	Food and Agriculture Organization of the United Nations
FDI	Foreign direct investment
FF1/FF2	Single/double-stage floc-filtration
FO	Forward osmosis
GAEZ	Global Agro-ecological Zones
GCC	Gulf Cooperation Council
GCM	General Circulation Model; global climate change model
GDP	Gross domestic product
GHG	Greenhouse gas
GIS	Geographic information system
GT	Gas turbine
GW	Gigawatt
GWh/y	Gigawatt hour/year
GWI	Global Water Intelligence
Ha	Hectare
HFO	Heavy fuel oil
HFO ST PP	Heavy fuel oil steam turbine power plant
HVDC	High-voltage direct current
ICBA	International Center for Biosaline Agriculture
IDRC	International Development Research Centre (Canada)
IEA	International Energy Agency
IIASA	International Institute for Applied Systems Analysis
IIP	Irrigation Improvement Project (The Arab Republic of Egypt)
IPCC	Intergovernmental Panel on Climate Change

ISET	<i>Institut für Solare Energieversorgungstechnik</i> (Institute for Solar Energy Technology)
IUCN	International Union for Conservation of Nature
IWPP	Integrated independent water and power project
IWA	International Water Association
IWRM	Integrated water resources management
IXR	Ion-exchange resin
JV	Joint venture
KA-CARE	King Abdullah City for Atomic and Renewable Energy (Saudi Arabia)
km <sup>2</sup>	Square kilometer
km <sup>3</sup>	Cubic kilometer
KSA	Kingdom of Saudi Arabia
kWh	Kilowatt hour
Lcd	Liters per capita per day
LEC	Levelized electricity cost
LWC	Levelized water cost
MASEN	Moroccan Agency for Solar Energy
MBR	Membrane bio-reactor
MCM	Million cubic meters
m <sup>3</sup> /d	Cubic meter per day
MED	Multiple effect distillation
MED-TVC	Multiple effect distillation-Thermal vapor compression
MEH	Multi-effect humidification
MENA	Middle East and North Africa Region
MEPI	Middle East Partnership Initiative
MF/UF/N	Micro-, ultra-, and nano-filtration
MJ	Megajoule
m <sup>3</sup>	Cubic meter
mm <sup>3</sup>	Cubic millimeter
MoU	Memorandum of understanding
MSF	Multi-stage (or Multiple-stage) flash distillation
mt	Metric ton
MT	Million tons
Mtoe	Million tons of oil equivalent
MVC	Mechanical vapor compression
NASA	National Aeronautics and Space Administration (U.S.)
NG	Natural gas
NREA	New and Renewable Energy Authority (Egypt)
NREL	National Renewable Energy Laboratory (U.S. DOE)
NRW	Nonrenewable water; nonrevenue water
OECD	Organisation for Economic Co-operation and Development

O.J.	Official Journal of the European Communities
OPEX	Operating expenditure
p.a.	Per annum
PB	Power block
PPA	Power purchase agreements
PPM	Parts per million
PPP	Purchasing power parity; public-private partnership
ProDes	PROMotion of Renewable Energy for Water Production through DESalination
PV	Photovoltaics
RCM	Regional climate model
RE	Renewable Energy
RO	Reverse osmosis
ROPME	Regional Organization for the Protection of the Marine Environment
SF	Solar field
SM	Solar multiple
SPS	Sanitary and phytosanitary services
SWCC	Saline Water Conversion Corporation (KSA)
SWRO	Seawater reverse osmosis
TES	Thermal energy storage
TWh	Tera-watt hour (=1 trillion watts/hour)
UF/MF	Low pressure ultrafiltration/microfiltration (membrane filtration)
UFW	Unaccounted-for-water
UNDP	United Nations Development Programme
USBR	United States Bureau of Reclamation
VAT	Value-added tax
VC	Vapor compression
VSP	Membrane distillation-variable salinity plant
WBGU	<i>Wissenschaftlicher Beirat der Bundesrepublik Globale Umweltveränderung</i> (German Advisory Council on Global Change)
Wh	Watt-hour
WHO	World Health Organization
YCELP	Yale Center for Environmental Law and Policy
ZLD	Zero liquid discharge (desalination)



# Overview

This volume contains six main messages:

1. *Water scarcity in the MENA Region has already become a challenge to development.* This scarcity will only grow over time due to increasing population, expected economic growth, and the likely impacts of climate change on water availability and demand. Our analysis shows that the water demand gap will quintuple by 2050, from today's 42 km<sup>3</sup> per annum to approximately 200 km<sup>3</sup> per annum. Closing this huge water gap will be costly and daunting. According to the analysis in this volume, even if all viable demand and supply management measures are implemented, the total cost of closing the water demand gap will be approximately US\$104 billion per year. This cost easily could go as high as US\$300 billion–400 billion a year if none of the demand management options is adopted.
2. *Demand management should be the first priority.* Effectively using available water, especially in the agriculture sector, will substantially reduce the demand gap. According to our analysis, if all economically feasible demand management measures are taken, the gap will be reduced from 199 km<sup>3</sup> to approximately 142 km<sup>3</sup> by 2050. However, economics is not the only factor that dictates selection of water supply options. Sometimes, the most economical options may be politically infeasible, and it is likely that governments would choose the more expensive options.
3. *Even if all demand management options are implemented, there still will be a water demand gap (approximately 93 km<sup>3</sup>), which should be met by “new” water.* Most of this new water for MENA will be desalinated; or, said differently, desalination will continue to play a critical role in MENA's future water supply portfolio.

4. *However, desalination is expensive and energy intensive and impacts the environment (from greenhouse gas [GHG] emissions and concentrates from desalination processes).* Today, countries in the region (including fuel-exporting countries) face tremendous pressure to ensure energy security. For example, Saudi Arabia—the single largest oil exporter in the world—is burning approximately 1.5 million barrels of crude oil equivalent every day to produce water (through desalination) and electricity generation. The trend is similar in most Gulf Cooperation Council (GCC) countries and in North African countries (Algeria and Libya) that rely heavily on desalination to meet a significant part of their water supplies. The status quo is not sustainable. Reducing the cost of desalination, eliminating its reliance on fossil fuel, and mitigating its environmental impacts are crucial.
5. *Renewable energy (RE) has tremendous potential to provide energy security and reduce GHG emissions in MENA.* Solar energy and in particular concentrating solar power (CSP) has significant benefits in MENA. Given its huge potential in terms of resources and significant prospect for development, CSP is a competitive energy supply option over time. Moreover, as the only economically viable RE technology to store and provide power on demand, CSP is especially suitable to power desalination plants, most of which are required to operate around the clock.
6. *CSP-powered desalination is expensive today, so significant efforts are needed by governments, the private sector, the donor community, and the public to make RE (mainly CSP) a significant part of the MENA Region's energy supply portfolio.* Various MENA countries have initiated ambitious programs to increase RE shares in their national energy portfolio mixes—ranging from a 5 percent to a 40 percent RE mix by 2020–30. Regional initiatives such as World Bank co-financed MENA CSP Investment Plan and DESERTEC have significant potential to bring down the cost of CSP. Equally important are national level initiatives that are underway in many countries in the region in terms of articulating bold and ambitious plans as well as forming institutions that spearhead such initiatives, including the United Arab Emirate's MASDAR Institute, Saudi Arabia's KA-CARE, Qatar's National Foundation, Morocco's MASEN, and the Arab Republic of Egypt's *New & Renewable Energy Authority* (NREA). More efforts are needed to realize the ambitious programs articulated by governments in MENA to ensure energy security and a sustainable water supply for MENA. To make CSP cost competitive, the role of developed countries to invest in research and development and production of CSP technologies at scale also is critical.

## Water Management Remains Serious Problem in Most MENA Countries

Per capita renewable water resources in MENA are among the lowest in the world. They will continue to decline, primarily as the result of population growth and climate change. The Food and Agriculture Organization (FAO) of the United Nations regards renewable water availability levels of less than 1,000 m<sup>3</sup> per person per year as a severe constraint to socioeconomic development and environmental sustainability. In fact, at levels of twice this water availability, water is regarded as a potentially serious constraint and, in drought years, as a major problem. By these criteria, reduced water availability already is a *serious* constraint to socioeconomic development in all 21 MENA countries. By 2030, due primarily to growing populations and partly to a warming climate, lack of water availability will become a *severe* constraint to socioeconomic development in all 21 countries. By 2050, two-thirds of MENA countries may have less than 200 m<sup>3</sup> of available water per capita per year.

Due to climate change impacts, water balance modeling indicates that the region's renewable water resources will decline significantly as a combined effect of the changes in precipitation and evapotranspiration (ET). Modeling does predict a very small increase in the average flow of the River Nile into MENA as a result of likely precipitation increases projected for the Upper Nile basin. However, this increase will be more than offset by decreasing precipitation and increasing ET within MENA. Thus, by 2050, under average climate change scenario, total renewable water resources will contract steadily by approximately 12 percent, equivalent to approximately 26 km<sup>3</sup> per year. Putting this amount in perspective, the region's current total urban demand is 28 km<sup>3</sup> a year.

Under average climate change scenario, MENA's water shortage will increase fivefold by 2050—from today's 42 km<sup>3</sup> to approximately 200 km<sup>3</sup> (see table O.1). This demand gap is expected to vary from 85 km<sup>3</sup> under the wet climate change scenario to approximately 283 km<sup>3</sup> under the dry climate change scenario. Closing this huge water gap will be expensive and daunting. The combined effects of population (expected to double from 316 million in 2010 to 697 million in 2050) and prosperity (regional gross domestic product (GDP) is expected to grow from the current US\$1.6 trillion to US\$6.5 trillion by 2030, and to US\$19 trillion in 2040–50) are projected to triple the total domestic water demand from current consumption of 28 km<sup>3</sup> to approximately 88 km<sup>3</sup> during 2040–50. Industrial water demand is projected to double from the annual regional current consumption of 20 km<sup>3</sup> to approximately 41 km<sup>3</sup> during the same period. Moreover, assuming the most likely average trend for climate

**TABLE O.1****MENA Annual Water Demand and Supply under Average Climate Change Scenario, 2000–50 ( $km^3$ )**

	2000–09	2020–30	2040–50
Total Demand	261	319	393
Irrigation	213	237	265
Urban	28	50	88
Industry	20	32	40
Total Supply	219	200	194
Surface water <sup>a</sup>	171	153	153
Groundwater	48	47	41
Total Unmet demand	42 <sup>b</sup>	119	199
Irrigation	36	91	136
Urban	4	16	43
Industry	3	12	20

Source: FutureWater 2011.

a. Surface water includes river flows into the MENA Region.

b. Summation does not add up due to rounding.

change, agricultural water demand will increase by approximately 25 percent (ranging from a 15 percent increase to a 33 percent increase in irrigation water demand under the wetter and warmer climate trend, and the warmer and drier climate trend, respectively).

Under the average climate projection scenario, all MENA countries will experience a dramatic growth of the demand gap. Countries currently facing limited or no water shortage will be confronted with large water deficits in the near and distant future. By 2050, the Arab Republic of Egypt, the Islamic Republic of Iran, Iraq, Morocco, and Saudi Arabia will see annual water shortages increase by 20–40  $km^3$ . The magnitude of the annual water gap in most countries will be relatively small compared with Iraq's huge 54  $km^3$  gap projected for 2050. For example, in the Republic of Yemen, the gap will be approximately 8.5  $km^3$ ; in Lebanon, approximately 0.85  $km^3$ . Nevertheless, the challenge of meeting their water gaps will be formidable, particularly for the poorer countries.

The growing demand gap poses the danger that, without an orderly transition to more sustainable supplies, considerable sections of the rural economy could collapse from lack of water. The current demand gap of 42  $km^3$  a year has been met partially through unsustainably mining fossil groundwater reserves and partially through providing desalination, particularly around the Gulf region. Groundwater mining is only a short-term fix to the supply problem. Rural collapse is particularly likely in the Republic of Yemen, whose aquifers are near exhaustion; and in Oman, whose groundwater mining is causing seawater intrusion and salinization of soils along the Batinah coast.

Despite significant scarcity, countries continue to allocate water to low-value uses, even as higher value needs remain unmet. Water supply service interruptions in MENA are common, even in years of normal rainfall. People and economies remain vulnerable to droughts and floods. In some countries, over-extraction of groundwater is undermining national assets by 1–2 percent of GDP every year. Water-related environmental problems cost MENA countries 0.5–2.5 percent of GDP every year.

Two alternatives are available to fill the water gap: (1) better management of available water and (2) finding new sources of supply.

## **Demand Management Must Be the First Priority**

Increasing efficient water use should be the first line of action. On the hottest days, irrigation of 1,000 ha in MENA consumes the water equivalent of each person in a city of 2 million consuming 100 liters per day. Despite the predominance of modern irrigation systems, MENA's average water use efficiency languishes at 50–60 percent. Pursued vigorously, improved irrigation scheduling, management, and technology could increase MENA's water use efficiency to more than the 80 percent level of the best-managed arid areas of Australia and the United States.

While of smaller magnitude, MENA's physical water losses in municipal and industrial supplies also typically exceed world averages. These water losses are approximately 30–50 percent in some cities, compared to international best practice of approximately 10 percent.

Excess demand in all water-using sectors is stoked by perverse and pervasive subsidies. Varying levels of transparency and governance give water supply agencies and utilities few incentives to improve service standards and promote water conservation. Given the high cost of new water supplies, adding new and more expensive water to such inefficient systems and uses clearly is not economically rational.

Progressive agricultural policy reform can provide incentives to reduce water demand. Driven by food security concerns, low-value wheat provides an exceptionally high 44 percent of the region's total food supply. Most of this wheat is grown locally using scarce water. The importance of wheat not only has driven substantial government investment in irrigation systems but also has led to subsidies on inputs (pumps, irrigation technology, and electricity) and on outputs through price support mechanisms.

Reducing subsidies for wells and pumps and for energy would significantly slow groundwater mining. Currently, groundwater users compete to use the resource before others can. Even worse, as the resource becomes more heavily exploited, groundwater levels fall so that only the farmers able

to afford the larger pumps remain in business. As a result, groundwater in the MENA Region is severely over-exploited, and many smaller farmers have been marginalized. Pricing electricity or diesel fuel at the levels equivalent to cost not only would constrain the volumes pumped but also would induce farmers to regain profitability by growing high-value crops.

However, even with realistic energy pricing, the cost of groundwater production does not represent its true value to the economy. Fossil groundwater is a finite and common pool resource that is being mined and, once gone, is irreplaceable. When farmers run out of fresh or moderately brackish groundwater, they typically have two choices: stop farming, or use an alternative resource. The only alternative source of water is desalinated water. In economic terms, the opportunity cost of groundwater is the same as its substitute, desalinated water, which costs US\$1.50 per  $\text{m}^3$ –2 per  $\text{m}^3$ , depending on location in MENA and the desalination technology.

Groundwater conservation thus is an important component of reducing MENA's future water demand. The two alternatives—desalination or abandoning agriculture—are either very expensive or politically challenging. Although mining groundwater may increase GDP in the short term, it undermines the country's natural capital or wealth in the longer term. The World Bank estimates that the value of national wealth consumed by over-extraction of groundwater could be as high as 2 percent of GDP.

Managing domestic water demand will be aimed primarily at reducing water loss on the supply side and reducing excessive consumption on the demand side. Only a small portion of MENA's population—those living in the Gulf states—has the luxury of almost unlimited water supply. Consequently, the major emphasis of the region's demand management will be to reduce network losses. Reducing losses is important for three reasons: consumers are paying for water utilities' inefficiencies; a precious and scarce resource is being wasted; and unnecessary investments in production are being made. If water supply utilities in MENA could be improved to international best-practice levels, as much as 5  $\text{km}^3$  a year could be saved.

## **Conventional Supply Management Options Are Limited**

Rainwater harvesting and check dams in wadis generally are very small and very local. Typically, they service single households or small communities and provide drinking water and groundwater recharge. From a regional perspective, they can make only a small contribution to supply augmentation except in rural areas.

Dams to impound larger volumes of water have limited potential in the MENA Region. Relative to the freshwater available, MENA's rivers are the most heavily dammed in the world. More than 80 percent of the re-

gion's surface freshwater resources already are stored behind reservoirs. Therefore, only limited potential exists to further increase water availability through dams. Nevertheless, some potential does exist, particularly in the more humid parts of the region such as northwestern Iran and the Atlas Mountains in Morocco and Algeria. Elsewhere, in the more arid MENA countries, the highly uncertain rainfall amounts and frequency frustrate reliance on reservoirs for assured supplies, a situation exacerbated by the likelihood of lower precipitation in the future.

## **Nonconventional Supply Management Options Are Essential**

Recycled wastewater is an assured resource and the only one that also is guaranteed to increase in response to population growth. Given that actual domestic consumption of water accounts for approximately 10 percent of household demand, the potential for reuse is large. If only 50 percent of this potential wastewater were recycled, it could add 20–40 km<sup>3</sup> per year to MENA's renewable water resources by 2050. While growth of wastewater will be driven by population growth, wastewater will need investment to extend collection and treatment networks. Most important, wastewater recycling needs to be explicitly included in national water planning policies, and well-designed campaigns are needed to ensure the public's acceptance of its use.

Desalination of seawater and brackish groundwater holds significant potential to bridge the water demand gap in MENA. Desalination already plays a critical role in MENA's water supply, particularly for countries in the Gulf region. This role is expected to extend to most countries in the MENA Region by 2050. Seawater effectively is an infinite water resource. Brackish groundwater reserves could be used to support salt-tolerant agriculture and/or be a source of desalinated water. Brackish groundwater reserves in MENA potentially are large, but extensive exploration is required to better define this resource. Desalination of brackish groundwater usually is much cheaper than desalinating seawater—the only alternative to groundwater in most MENA countries. However, for large-scale applications, seawater desalination provides the most obvious solution to MENA's water supply shortage.

## **Closing the Water Gap of Almost 200 km<sup>3</sup> Will Be Challenging and Expensive**

In this volume, the most cost-effective sources to fill the demand gap were determined using optimization modeling, which took into account the

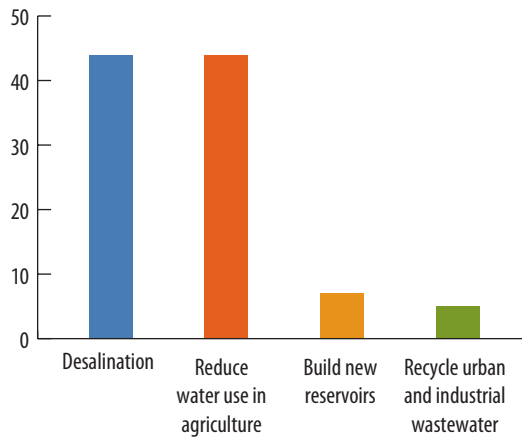
**FIGURE O.1****Sources of New Water Supplies by 2050 (percent)**

Source: Authors' calculations.

individual country-specific circumstances, water endowments, and use (figure O.1). The principle was to use the least expensive water first and the most expensive water last. One obvious and important finding is that managing agricultural water demand, even if more difficult to plan and predict, could provide as much water as new desalination.

The least expensive options to save water could come from improving agricultural cropping systems and trade, improving irrigation water use, and expanding reservoir capacity. Combining these measures could provide an additional 78 km<sup>3</sup> of water at less than US\$0.05 per m<sup>3</sup>. Reallocating water used in low-value irrigation to other uses would increase water supply by 24 km<sup>3</sup>. However, reallocation would be almost twice as expensive as improving water use within agriculture. After all of these demand management measures were fully exploited, the unmet demand gap still would be 97 km<sup>3</sup>. Using recycled domestic and industrial wastewater costing US\$0.30 per m<sup>3</sup> and recycled irrigation water costing US\$0.40 per m<sup>3</sup> would increase water supply by an additional 21 km<sup>3</sup>.<sup>1</sup> The remaining water gap of 76 km<sup>3</sup> could be filled only by desalination.

The annual cost of providing the additional 200 km<sup>3</sup> is large. If none of the demand management options has been implemented and if desalination is the only option available to bridge the water demand gap by 2050, the total cost to bridge the 200 km<sup>3</sup> water gap will be US\$420 billion. However, if all of the above demand reduction measures have been implemented, the total cost of closing the water demand gap will be approximately US\$104 billion. On top of adopting optimal combinations of the tactical options indicated above, the lower cost assumes that desalina-



tion technology will improve; that conventional energy sources progressively will be replaced by renewable energy (RE); and that RE sources will become less expensive over the long term.

### Desalination Can Help Close the Gap—at a Cost

Desalination enables communities to utilize available brackish groundwater and the practically inexhaustible supply of seawater. In the past, the difficulty and expense of removing salts from water made desalination expensive. However, over the years, advances in desalination technologies have made it an economically viable alternative source of fresh water. Subsequently, in response to shortages of naturally renewable water supplies, many MENA countries developed desalination facilities. By 2007, over 50 percent of the world’s desalination potential was installed in MENA, primarily in the Gulf region (figure O.2).

Desalination has proved to be a technically feasible supply solution to MENA’s water gap and will continue to be so. Although desalination currently provides only slightly more than 3 percent of total regional water demand, some MENA countries depend on desalination to supply 50–99 percent of their municipal water use. This trend is expected to increase to more countries in the region. Under the average climate change scenario, assuming that all viable demand and supply management measures have been implemented, by 2050 desalination may have to provide as much as 19 percent of regional water demand.

During the 1960–80s, large-scale freshwater supply was distilled from seawater. Distillation has a number of advantages, especially in the Gulf

**FIGURE O.2**

**Distribution of Worldwide Desalination Capacity, 2007**

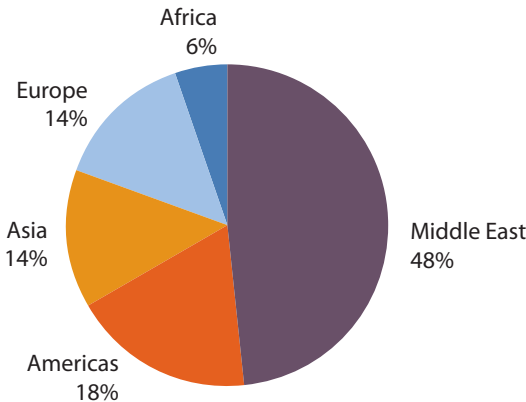

Source: Lattemann 2010.

region, in which fossil fuels are abundant and cheap. Consequently, most of the Gulf developed cogeneration infrastructure for electrical power with fresh water as a byproduct using the multistage flash (MSF) distillation process. Costs were well understood and were little affected by the salinity of the source waters. More recently, the multiple effect distillation (MED) technology has been replacing MSF because of MED's lower energy demand. In contrast, membrane technologies, which effectively sieve out salt from water, had difficulty coping with the high salinity of the Gulf water and were both small scale and costly.

Today, however, membrane technologies, especially reverse osmosis (RO), have made major advances and are competitive with distillation. Initially, the RO membranes were expensive; pretreatment was not well understood; and energy consumption was high. Due to advances in membrane technology and pretreatment options, membrane prices have fallen; their performance has improved; and pretreatment is better understood. Even though RO energy use increases in proportion to the concentration of salt to be removed, energy consumption has dropped dramatically over the last 20 years. Moreover, RO plants do not need to be coupled with thermal power plants in cogeneration stations; RO requires only electrical energy. As a result, outside the Gulf Region, the preferred technology is RO.

Distilling seawater produces a concentrated brine waste that is three to four times the volume of the fresh water produced. In contrast, RO produces brine volumes only 1.0–1.5 times the freshwater production;<sup>2</sup> and if the brine disposal problem can be managed, RO plants do not have to be located near the sea.

Both distillation and membrane desalination technologies require large energy inputs, which account for one-third to one-half of freshwater production costs when fossil fuels are used. Importantly, the current high reliance on fossil fuels for power generation produces large volumes of GHG. Thus, continued reliance on fossil fuels and the greater future demand for energy for desalination will exacerbate global warming trends.

In comparative terms, and considering all investment and operations and maintenance (O&M) costs and a continued reliance on fossil fuels, fresh water produced by distillation is slightly more expensive than that produced by RO. However, much depends on the quality of source water, scale, and site conditions. For example, in the Gulf water, whose salinity and water temperature are significantly high, water production using RO is more expensive than that using MED. Typical annual costs per cubic meter of fresh water are US\$1.0–1.4 for RO, and US\$1.2–1.6 for distillation (table O.2). By 2050 due to the projected price increase for fossil fuel, such typical annual costs are estimated to reach as high as US\$2.50 per m<sup>3</sup> of fresh water produced.

**TABLE O.2****Total Annualized Cost of Desalinated Seawater (US\$ per m<sup>3</sup>)**

	MSF	MED	SWRO
Mediterranean Sea	—	1.36–1.59	1.08–1.32
Red Sea	—	1.28–1.43	1.06–1.23
Gulf water	0.84 (1.6)	1.21–1.34	1.23–1.36

Sources: Fichtner and DLR 2011; United Arab Emirates' Regulation and Supervision Bureau 2009.

Note: MSF costs are based on actual contracted prices and electricity price in United Arab Emirates of US\$0.068 per kWh (UAE). The number in parentheses is the equivalent cost of desalination based on unsubsidized energy cost. For MED and seawater reverse osmosis (SWRO), the costs are based on feasibility studies for large projects by Fichtner and DLR 2011 (assuming project life of 25 years, discount rate of 6 percent and unsubsidized energy cost). In this volume, energy costs were calculated based on the opportunity cost of fuel at the international price and fuel escalation cost of 5 percent per annum (see appendix C). Unit costs under MSF and MED or SWRO for the Gulf region are not comparable as they do not correspond to the same desalination plant. — = not available.

If future desalination in MENA continues to rely on fossil fuels, energy costs will be more likely to increase, due to greater international competition for limited fossil fuel reserves. The price volatility of fossil fuels will be another challenge. In addition, as mandatory mitigation of the effect of CO<sub>2</sub> emissions on climate change becomes internationally institutionalized, power generation technologies based on hydrocarbons increasingly will be charged with the extra costs of CO<sub>2</sub> sequestration.

### Fossil-Fuel-Based Desalination Is Not Sustainable

The biggest challenges will be to reduce the cost of energy-intensive desalinated water, reduce its reliance on fossil fuels, and ensure that it becomes an environmentally acceptable solution.

Costs can be reduced in several ways: (1) by improving technology to increase the efficiency of desalination, (2) by reducing the cost of the current technology (initial capital costs and operational costs, including lowering the cost of financing), (3) by lowering energy costs, and (4) by reducing environmental damage from desalination.

Over the last three decades, research has systematically lowered desalination costs, primarily through better design, more efficient energy use, and post-process energy recovery. Such improvements are expected to continue. Nonetheless, the question remains of how the energy costs can be reduced in the face of rising global competition for fossil fuels.

Desalination will increase future energy requirements and take a large share of national energy production. For example, in Saudi Arabia, the world's largest oil exporter, desalination and electricity generation alone

requires burning approximately 1.5 million barrels of crude oil equivalent per day. The trend is similar in most Gulf Cooperation Council (GCC) countries and beyond, in whose water supply portfolios desalination plays a significant role. As water demand accelerates, so will the proportion of national energy demand devoted to desalinating water. In Saudi Arabia, for example, it is estimated that, if no improvements in energy efficiency are made and current trends continue, domestic fossil-based fuel demand is on track to reach over 8 million barrels per day of crude oil equivalent by 2040.

Using current technology, desalination will have large environmental impacts by 2050. First, the annual volume of brine produced will be approximately 240 km<sup>3</sup>, compared to 40 km<sup>3</sup> now. Second, the incremental volume of GHG emissions will be approximately 400 million tons of carbon equivalents per year. Comprehensive and consistent regional and national environmental legislation is necessary to protect groundwater and shared waterbodies from pollution from concentrate (brine plus other chemicals). This necessity is especially critical for waterbodies that already have large desalination plants installed or planned, such as the Gulf. For the necessary measures to be effective, it is important for countries to jointly plan and implement them.

Joint studies and continuous monitoring also should be undertaken to better understand the adverse impacts of brine surface water disposal on marine ecosystems and inland disposal on groundwater aquifers.

The above trends in energy security, fiscal burden, and environmental implications of fossil fuel-based desalination problems, which are the elements of a business-as-usual (BAU) scenario, are worrisome and should be addressed in a timely manner to maintain the Region's socioeconomic and environmental wellbeing. Many of these desalination-related problems could be reduced by replacing fossil fuels with renewable energy (RE) sources.

## Renewable Energy Can Provide Win-Win Solutions

The coupling of renewable energy sources with desalination has the potential to provide a sustainable source of potable water. The technical and economic potential of RE resources for power generation differs widely among MENA countries. The annual potential of wind power, biomass, geothermal, and hydropower combined totals approximately 830 trillion watt-hours. Although these resources are concentrated more or less locally and are not available everywhere, they can be distributed through the electricity grid to meet growing electricity demand. By far, the biggest resource in MENA is *solar irradiance*, which is available everywhere in the

region. MENA's solar energy has a potential 1,000 times larger than its other renewable sources combined and is several orders of magnitude larger than the current total world electricity demand. MENA's potential energy from solar radiation per square kilometer per year is equivalent to the amount of energy generated from 1–2 million barrels of oil.

This copious resource can be used both in distributed photovoltaic (PV) systems and in large central solar thermal power stations. While PV can economically generate only electricity, solar energy captured and re-directed by mirrors to heat fluids—called concentrating solar power (CSP)—can generate both heat and electricity. While electricity cannot be stored as electrical energy, heat can.

CSP was selected for analysis in this volume for two reasons: (1) it has the potential to store heat so it can provide baseload for desalination; and (2) it has significant potential for technological improvement and significant cost reduction. With sufficient heat storage capacity, CSP potentially can provide baseload power 24 hours a day. The efficiency of today's solar collectors ranges from 8–16 percent, but by 2050, technical improvements are expected to increase efficiency to the 15–25 percent range. Currently, the solar energy collector field comprises more than half of the investment cost. Thus, improvements in collection efficiency indicate significant potential for cost reduction.

However, despite its significant potential for development, CSP today is not economically competitive compared to conventional energy sources and most RE technologies such as wind and PV (table O.3). To mature and become cost effective, CSP will continue to need strategic support. Such strategic support could be a combination of energy policy reforms to eliminate barriers, such as eliminating fossil fuel subsidies, creating an enabling environment for long-term power-purchase agreements and feed-in-tariffs, and supporting initial investments and R&D related to CSP.

Based on assumptions adopted by this volume to develop CSP (figure O.3), the costs of fresh water produced by CSP thermal and RO membrane desalination plants vary considerably in the Mediterranean Sea, Gulf, and Red Sea regions due primarily to differing seawater salinity. CSP-RO provides the lowest cost water in the Mediterranean and Red Sea regions, ranging from US\$1.52–1.74 per m<sup>3</sup> (table O.4). CSP-RO costs also vary depending on coastal or inland locations. Inland, higher solar radiation may reduce costs by as much as US\$0.15 per m<sup>3</sup>.

Figure O.3 shows the applied strategy for a fictitious case country in MENA. Annualized costs of fossil-fuel power generation are expected to increase in the future. Thus, the current cost of peaking power is projected to rise from its present US\$0.21 per kWh to more than US\$0.35 per kWh by 2050. Medium- and baseload power will be less expensive but will follow a similar trend. In contrast, present CSP costs of approxi-

**FIGURE O.3**

**Electricity Cost of Concentrating Solar Power Plants Compared to Specific Cost of Peak-, Medium-, and Baseload Plants (annualized costs)**

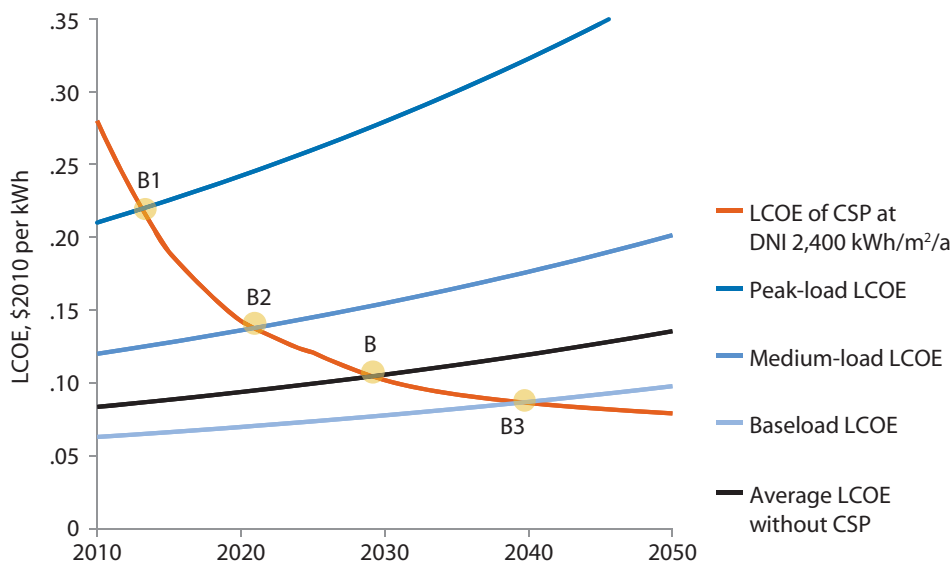

Source: Trieb and others 2011.

Note: a = annum; B = break even with average electricity cost; B1 = break even with peaking power; B2 = break even with medium load; B3 = break even with baseload; LCOE (levelized cost of electricity) = LEC (levelized electricity cost).

**TABLE O.3**

**Levelized Costs of Electricity of CSP<sup>a</sup> and Other Technologies (US\$ per MWh)**

Energy source	CSP <sup>a</sup>	Wind	PV	Gas CCGT	Simple cycle GT
LEC	196	102	100	80	116

Source: World Bank 2009.

Note: LEC calculation is based on 25 years. For plant economic life and 10 percent discount rate. LEC = levelized electricity cost; CCGT = combined-cycle gas turbine; GT = gas turbine.

a. Reduction in LEC for CSP by 45–60 percent is anticipated by 2030 due to a combination of economies of scale (21–33 percent), efficiency increases (10–15 percent), and technology improvements (18–22 percent).

**TABLE O.4**

**Total Annualized Cost of RE-Desalinated Seawater (US\$ per m<sup>3</sup>)**

	CSP-MED	CSP-SWRO
Mediterranean Sea	1.97–2.08	1.50–1.74
Red Sea	1.87–1.96	1.56–1.66
Gulf water	1.77–1.89	1.78–1.87

Source: Fichtner and DLR 2011.

Note: The costs assume a hybrid plant with solar share of 46–54 percent, project life of 25 years, and discount rate of 6 percent. Energy costs were calculated based on the opportunity cost of fuel at the international price and the fuel escalation cost of 5 percent p.a. (appendix C).

mately US\$0.28 per kWh are expected to fall to approximately US\$0.08 per kWh by 2050. Starting a CSP project in 2011 could have enabled a first plant to be installed by 2013 (point B1) supplying peaking power. By that time, the plant already would have been competitive with new conventional peaking plants fired with fuel oil. Plants installed in subsequent years in the same power segment will be even less expensive. By approxi-

mately 2020, CSP will start to be competitive with medium-load power plants (B2). If this process is continued by filling up the medium-load segment with CSP and substituting more and more fuel in this sector, the break-even with the average electricity cost will be achieved before 2030 (point B). By 2040 CSP will break even in the baseload segment (B3).

Currently, CSP thermal desalination is more expensive than CSP-RO except in the Gulf, where water salinity is high. The indicative water costs at present prices for CSP thermal range from US\$1.80 per m<sup>3</sup>–2.08 per m<sup>3</sup>. By 2050 such typical annual costs are estimated to decline to as low as US\$0.9 per m<sup>3</sup> of fresh water produced due to technological innovations.<sup>3</sup> CSP adoption also will bring considerable environmental advantages. The increased share of CSP-RO desalination allied with the more efficient CSP thermal desalination will reduce annual brine production by nearly half—from 240 km<sup>3</sup> to 140 km<sup>3</sup>.

Increased RE use will significantly reduce CO<sub>2</sub> emissions. Generating a gigawatt hour of electricity using oil produces 700 tons of CO<sub>2</sub>. Using gas produces 450 tons. In contrast, to generate the same amount of electricity, CSP produces only 17 tons of CO<sub>2</sub>. This vast difference will apply not only to desalination but also to MENA's energy sector as a whole because introduction of large scale RE desalination will not be done in isolation. From 2010 to 2050, total MENA electricity demand is expected to quintuple. Current CO<sub>2</sub> emissions are 573 million tons a year. Using conventional fossil fuels, CO<sub>2</sub> emissions would rise to 1,500 million tons by 2050. If RE replaces fossil fuels except for peaking power, MENA's annual CO<sub>2</sub> emissions could be reduced to 265 million tons by 2050—this is less than even current emissions.

CSP desalination will take time to mainstream because many existing and currently planned fossil fuel desalination plants will remain in operation for some years. Because most fossil fueled desalination plants will not be totally decommissioned until 2041–43, demand for CSP desalination technology will grow slowly at first—to meet growing water demand. During this period, it will be essential that the supply of CSP desalination technology keep pace with demand because, without this technology, a number of countries will have to mine their groundwater reserves even more intensively to survive in the short to medium term. Moreover, in the short and medium terms, CSP still will need to be supplemented by fossil fuels for some baseload and peak-power generation.

## **MENA's Water Crisis Is Deepening**

The severity of the water crisis in the MENA Region varies considerably from one country to another. Different countries, even in the same sub-

region, face different choices and costs regarding how to close their water gaps. The average adaptation cost in MENA for each additional cubic meter of water required is approximately US\$0.52, but this cost varies substantially among countries. Algeria's improved agricultural practice can almost bridge the gap at US\$0.02 per m<sup>3</sup>. At the other extreme, in the United Arab Emirates, the gap will be bridged primarily by desalination at US\$0.98 per m<sup>3</sup>. Even with adaptation measures, Iraq, Morocco, and the United Arab Emirates will not be able to economically close their water gaps without additional decreases of irrigated area and/or consumption. Eight of the most water-short countries will carry most of the financial burden of closing the gap. Iraq will bear most of the cost, followed by Egypt, the Islamic Republic of Iran, Israel, Morocco, Saudi Arabia, the United Arab Emirates, and the Republic of Yemen. The remaining 13 MENA countries combined will bear less than 10 percent of the total financial burden. For the 21 MENA countries, at current prices, by 2050 the average annual adaptation costs per capita will be approximately US\$148.

By 2050, filling the water gap will cost approximately 6 percent of current regional GDP. Given that regional GDP will grow by 2050, the actual average share of GDP devoted to providing water supply will be lower. However, countries differ markedly based not only on the severity of their water shortages but also on their projected GDP. In the future, Iraq, Jordan, Morocco, and the Republic of Yemen must be prepared to spend a substantial amount of their GDP on overcoming their water shortages. In the Republic of Yemen, for example, closing its water gap may take as much as 4 percent of its GDP.

### **Costs of Inaction Will Be High**

Managing demand, particularly of agricultural water use, will be key to reducing the high costs of filling the water gap. In the near term, prior to the widespread use of RE, failure to save water and to reduce uneconomic use will have severe socioeconomic and environmental repercussions—because the only alternative will be desalination using expensive fossil fuels.

Desalination will continue to play an ever-increasing role in MENA's water supply portfolio. However, if the current trend of using fossil fuel for desalination continues, many MENA countries will face serious energy security problems in general and, for oil-exporting countries, economic problems in particular.

Similarly, the environmental implications of scaled-up desalination cannot be ignored. Single pollutants and multiwaste components have



adverse impacts on the marine environment. Comprehensive and consistent regional and national environmental laws are necessary to protect groundwater and shared waterbodies from pollution. This need is especially critical for waterbodies that already have large desalination plants installed or planned, such as the Gulf. For these necessary measures to be effective, it is important for countries to jointly plan and implement them. Joint studies and continuous monitoring also should be undertaken to better understand the adverse impacts of brine surface water disposal on marine ecosystems and inland disposal on groundwater aquifers.

## Next Steps

MENA will reap three major benefits from coupling desalination with RE sources, particularly the region's virtually unlimited solar irradiance: (1) a sustainable water supply, (2) an energy-secure water sector, and (3) environmental sustainability. However, to make these sources more competitive, actions must be taken today to encourage investments in RE technologies and improvements in desalination efficiency. All MENA countries have set policy targets or created supportive renewable energy policies. Nevertheless, concrete commitments that drive action on the ground are still missing. More work is needed to prepare bankable RE projects and coupled RE desalination projects in MENA.

Similarly, regional initiatives such as the World Bank co-financed MENA CSP investment plan and the DESERTEC initiative (German based initiative enacted to shape a sustainable energy and water supply for MENA and EU countries) should proceed with implementation. EU countries should make RE-based energy from MENA economically attractive and, in terms of exporting RE to EU countries, procedurally simple and easy.

Equally important are the efforts that developed countries need to make to develop new technologies and/or support production of promising technologies at a scale to bring down the cost of RE. For example, the role that the government of Germany has played over the last few years to significantly bring down the cost of PV is commendable. Due to Germany's adoption of a preferential feed-in-tariff policy for PV-based RE sources, significant improvements in PV technology and cost saving have been achieved. These great achievements have helped not only Germany but also other countries to access PV-based RE energy sources. Similar initiatives could be supported by other developed countries that have comparative advantage in terms of technology and resources, including institutional and human capacity, to achieve better results for the common good.

## Notes

1. Recycling domestic and industrial wastewater would add 13 km<sup>3</sup> whereas recycling only industrial wastewater would add approximately 8 km<sup>3</sup>.
2. However, generally, brines from RO plants are more concentrated than those from thermal desalination plants.
3. Based on the assumption that, due to technological advances, the present CSP costs of approximately US\$0.28 per kWh will fall to approximately US\$0.08 per kWh by 2050.

## References

- Fichtner and DLR. 2011. *MENA Regional Water Outlook, Part II, Desalination Using Renewable Energy, Task 1–Desalination Potential; Task 2–Energy Requirements; Task 3–Concentrate Management*. Final Report, commissioned by the World Bank, Fichtner and DLR. [www.worldbank.org/mna/watergap](http://www.worldbank.org/mna/watergap).
- FutureWater. 2011. *Middle-East Northern Africa Water Outlook. Final Report*, commissioned by the World Bank, W. Immerzeel, P. Droogers, W. Terink, J. Hoogeveen, P. Hellegers, and M. Bierkens (auth.). Future Water Report 98, Wageningen, the Netherlands. [www.worldbank.org/mna/watergap](http://www.worldbank.org/mna/watergap).
- Lattemann, S. 2010. “Development of an Environmental Impact Assessment and Decision Support System for Seawater Desalination Plants.” PhD Dissertation, the Netherlands.
- Trieb, F., H. Müller-Steinhagen, and J. Kern. 2011. “Financing Concentrating Solar Power in the Middle East and North Africa: Subsidy or Investment?” *Energy Policy* 39: 307–17.
- United Arab Emirates (UAE). 2009. *Switched on*. Annual Report for the Water, Wastewater and Electricity Sector in the Emirate of Abu Dhabi. Dubai: The Abu Dhabi Regulation and Supervision Bureau. <http://www.rsb.gov.ae/uploads/AnnualReport2009.pdf>.
- World Bank. 2009. *Clean Technology Funds Investment Plan for Concentrated Solar Power in the Middle East and North Africa Region*. Washington, DC: Inter-Sessional Meeting of the Clean Technology Fund Trust Fund Committee, World Bank.

# Introduction

The Middle East and North Africa (MENA) Region is considered the most water-scarce region in the world. Large-scale water management problems already are apparent in the region. Aquifers are over pumped; water quality is deteriorating; and water supply and irrigation services often are rationed. Each of these conditions has consequences that impair human health, agricultural productivity, and the environment. Disputes over water create tensions within communities. Moreover, unreliable water services are prompting people to migrate in search of better opportunities. Water investments absorb large amounts of public funds, which often could be used more efficiently elsewhere. These challenges appear likely to escalate. As the region's population continues to grow, per capita water availability will decline. If climate change affects weather and precipitation patterns as predicted, the region may see more frequent and severe droughts and floods, and reduced water availability overall.

One of MENA's major challenges is to manage water to sustainably increase agricultural production, as required by its fast-growing population, while increasing trade in agricultural products. The 2006 United Nations Food and Agriculture Organization (FAO) study, "World Agriculture: Towards 2030/2050," shows that global agricultural demand will slow because population growth rates are stabilizing and many countries already have reached fairly high levels of per capita food consumption. Globally, FAO expects that agricultural production can grow in line with agricultural demand. However, MENA's situation differs because high population growth rates are expected and water already is a crucial constraint.

The Fourth Assessment Report (AR4) of the International Panel on Climate Change (IPCC 2007) projects dramatic changes in climate across the MENA Region during this century. Temperature increases combined with substantially decreasing precipitation are projected. Because

the elevated temperature will result in a higher evapotranspiration demand, the higher temperature, in combination with the decreased precipitation, will severely stress the region's water resources.

The 2007 World Bank study *Making the Most of Scarcity: Accountability for Better Water Management Results in the Middle East and North Africa* asks whether MENA countries can adapt to meet these combined challenges. The study argues that they must, because if they do not, the social, economic, and budgetary consequences will be enormous. Drinking water services will become more erratic than they already are. Cities will come to rely more and more on expensive desalination and on emergency supplies brought by tanker or barge. Service outages stress expensive water network and distribution infrastructure. In irrigated agriculture, unreliable water services will depress farmers' incomes and lower productivity. The economic and physical dislocations associated with the depletion of aquifers or unreliability of supplies will increase. All of these developments will have short- and long-term effects on economic growth and poverty and will increasingly pressure public budgets. The 2007 study concludes that the MENA countries have made considerable progress in dealing with the water problems, but that their efforts have focused on reducing physical water scarcity and improving organizational capacity. To further redress the region's water challenges, additional basic economic and institutional reforms must be implemented. At the same time, a longer term vision of MENA's water future must be developed. Only through such a vision can the type and magnitude of demand be determined and relevant infrastructure investments made.

The MENA Region has a fairly broad range of available water resource and technology options. These options can be grouped by approach, such as reducing demand, transferring between sectors, transferring within sectors, increasing storage, and increasing supply. As renewable water resources become fully utilized, another important option for the MENA Region is increased reliance on desalination.

### **Origin and Purpose of This Study**

To explore the options available to MENA, the World Bank initiated the current regional study in 2010. The objective is to generate an improved understanding of water issues in the region through a common assessment framework, a deeper understanding of the impacts of climate change, and an updated overview of water supply and water demand in the region today and in the future. Moreover, the study aimed at assessing the viability of desalination to close MENA's growing water gap, including associated technological, economic, and environmental implications.

Given the energy intensity of desalination, and energy security challenges of oil importing countries and foregone revenue stream for oil exporting countries, fossil-fuel based desalination is not sustainable. However, the region's renewable energy (RE) potential is huge, especially for solar energy and, in some countries, for wind. As such, the study also assessed the viability of RE (and, more specifically concentrating solar power, or CSP) desalination in MENA.

Although earlier studies provide insight in the severity of the problem and first assessments of how to overcome the projected water shortage, a solid and comprehensive assessment of MENA's current and future water resources was lacking. Previous studies had based their analyses on annual country statistics and generalized assumptions on future developments. No common analytical framework had been applied equally to climate, hydrological simulation, and demand assessment. Thus, the first commissioned study, "Middle East and North Africa Water Outlook to 2050" (Future-Water 2011), focused on the assessment of water supply and demand in the MENA Region to 2050 and the implications of climate change impacts on water supply and demand, and on cost-optimization of water use.

That study integrated country- and area-specific climatic, hydrological, and water use information based on a common standard. These data were used as input to calibrate a series of country-level hydrological models, summarized at both country and regional levels. Where relevant, cross-border inflows—from the rivers Nile, Tigris, and Euphrates—also were modeled. Subsequently, the most likely future climate scenarios were used to project future water availability. The next step undertook a supply-demand gap analysis. Under all future climate scenarios, renewable water resources will become severely stressed by 2050. The consequence will be that, for many MENA countries, desalination will become a major supply source. The energy-intensive nature of desalination provided a particular challenge. If continued in the future, desalination's current reliance on burning fossil fuels would exacerbate global warming and worsen MENA's climatic outlook.

Because desalination is likely to become central to filling the supply-demand gap, a second study was commissioned: "Use of Desalination with Renewable Energy to Close the Water Demand Gap in MENA" (Fichtner and DLR 2011). This study did an in-depth technical review of current and likely future options for desalination and its costs, energy requirements, and environmental considerations. This second study analyzed the potential viability of different configurations of desalination and RE in MENA, and the implications of scaled-up desalination on the environment. Given MENA's comparative advantage and high endowment of renewable solar energy, the second study looked at the viability of solar energy as an energy source in general and its use for desalination.

## Chapter Summaries

The current volume synthesizes these two major commissioned studies and builds on a substantial body of additional earlier work produced by MENA countries, researchers, policymakers, and the World Bank.

Chapter 2 assesses current and future water availability and water demand. In general, water demand for domestic and industrial use correlates strongly with the level of economic development. Future demands from these sectors are projected based on the country-level growth of population and gross domestic product (GDP).<sup>1</sup> Current and future water demand projections for irrigation are based on the 2006 FAO study noted above. Current and future water supply projections are based on climatic, hydrological, population, and land use data for each 5-minute square (approximately 100 km<sup>2</sup>) of the region used in a linked hydrological model to simulate river flows where applicable. By this means, the current study modeled fairly complex hydrological systems. The models also include the effects of the IPCC (2007) climate change projections downscaled at 10-km grid to determine future water resources availability and agricultural water demand.

In all cases, the models demonstrate an intensifying, but geographically uneven, water crisis because renewable water resources in most MENA countries will not be able to meet future demands. Chapter 2 also discusses the lessons learned from demand and supply management globally and from the World Bank's experience in MENA. While demand and supply management may reduce the severity of water shortages, in most cases, improved management will only delay their onset.

Chapter 3 draws on the findings and methodology of the 2030 Water Resources Group study "Charting Our Water Future" (2009) to identify the potential mix of technical measures to close the supply-demand gap for the MENA Region as a whole and for each country in particular. Using "water-marginal cost curves" for the countries, the magnitude of adaptation costs is indicated as a tool to support policy- and decision-making.

Chapter 4 reviews the growth of desalination in MENA and the current state of desalination technology. The chapter provides a brief overview of advances over time in desalination technology and its implications, especially on energy consumption per unit of freshwater production. Chapter 4 shows that energy consumption of different desalination technologies (particularly for reverse osmosis [RO] technology) per unit of freshwater produced has reduced significantly over the years. The chapter also highlights the cost of conventional energy desalination. A comprehensive review of RE potential in MENA is also covered in this chapter.

Chapter 5 discusses the growth of RE desalination globally. It shows that production units are in operation and technically feasible. These

units also can produce desalinated water on the scale needed to meet the growing demand gap. This chapter also highlights the challenges that lay ahead in bringing RE (especially CSP) as a competitive energy supply option in MENA. The chapter provides a preliminary cost estimate of CSP desalination today and potential cost reduction in the future.

Chapter 6 supplies an overview of the environmental impacts of desalination and the opportunities to alleviate them. Given the critical role that desalination will play in MENA's future water supply, the chapter highlights the importance for the countries in the region to adopt a minimum environmental quality standard regarding concentrate disposal to the shared seas and inland. The chapter calls on MENA countries to take note of the cumulative impacts of disposing concentrate (brine) on marine and terrestrial ecosystems. Also very important, the use of RE for desalination significantly lowers the production of greenhouse gases (GHGs) in the region. This result signals that renewables and desalination are a win-win technological partnership.

Chapter 7 takes a more holistic view of the energy demands of desalination vis a vis the region's future energy production. The chapter demonstrates that future water planning using desalination must be done in partnership with regional energy planning. Importantly, there could be MENA-Europe and Central Asia (ECA)-MENA-European Union (EU) energy partnerships based on MENA's exporting RE to the North. Such interregional partnerships also could be win-win because solar-derived energy exports could underwrite MENA's food security as the region's agricultural production of staples becomes constrained by the unavailability of affordable water. In addition, scaling up adoption of solar power in MENA could go a long way to encourage innovation that would lower desalinated water production costs. The chapter also summarizes the list of technological, institutional economic/financing, and environmental barriers that limit the adoption of RE desalination in MENA; and the ways to alleviate them.

Chapter 8 highlights the major findings of this volume. The first and most important is that efficiently managing agricultural water demand, even if more difficult to plan and predict, could provide as much water as new desalination. While new desalination will fill the demand gap, attention also has to be given to greater reuse of wastewater—the only growing water resource in the region. Second, the study concludes that, even though RE options, particularly solar, are relatively expensive today, their future scope to provide energy security and reduce GHG emissions is tremendous. This chapter concludes that significant efforts are needed by governments, the private sector, the donor community to make RE a significant part of the MENA Region's energy supply portfolio.

## Note

1. Population and GDP projections up to 2050 were taken from Center for International Earth Science Information Network (U.S.) at Columbia University.

## References

- 2030 Water Resources Group. 2009. "Charting Our Water Future: Economic Frameworks to Inform Decision-Making." [http://www.2030waterresourcesgroup.com/water\\_full/Charting\\_Our\\_Water\\_Future\\_Final.pdf](http://www.2030waterresourcesgroup.com/water_full/Charting_Our_Water_Future_Final.pdf).
- Fichtner and DLR. 2011. *MENA Regional Water Outlook, Part II, Desalination Using Renewable Energy, Task 1–Desalination Potential; Task 2–Energy Requirements; Task 3–Concentrate Management*. Final Report, commissioned by the World Bank, Fichtner and DLR. [www.worldbank.org/mna/watergap](http://www.worldbank.org/mna/watergap).
- FutureWater. 2011. *Middle-East Northern Africa Water Outlook. Final Report*, commissioned by the World Bank, W. Immerzeel, P. Droogers, W. Terink, J. Hoogeveen, P. Hellegers, and M. Bierkens (auth.). Future Water Report 98, Wageningen, the Netherlands. [www.worldbank.org/mna/watergap](http://www.worldbank.org/mna/watergap).
- IPCC (Intergovernmental Panel on Climate Change). 2007. *Climate Change 2007: Synthesis Report*. Contribution of Working Groups I, II and III to the Fourth Assessment Report of the IPCC (AR4), Geneva. [http://www.ipcc.ch/pdf/assessment-report/ar4/syr/ar4\\_syr.pdf](http://www.ipcc.ch/pdf/assessment-report/ar4/syr/ar4_syr.pdf).



## MENA's Water Gap Will Grow Fivefold by 2050

If current rates of growth continue and the global climate warms as expected, water demand in the MENA Region is expected to increase 50 percent by 2050 (table 2.1). Currently, total water demand exceeds naturally available water supplies by almost 20 percent. By 2050, the water demand gap is projected to grow fivefold. This already quite substantial unmet demand clearly reflects the conditions in MENA, in which water shortages are occurring in most countries. Today's unmet demands are met primarily through unsustainably mining fossil groundwater reserves and partially by increasing water supplies through desalination.

Despite the ever-increasing water scarcity, most water in MENA continues to be used to grow low-value crops in response to countries' concerns about food security. Irrigated agriculture accounts for approximately 81 percent of regional water use. Despite the predominance of modern irrigation systems, only 50–60 percent of this water use is efficient. Mu-

**TABLE 2.1**

### MENA Annual Water Demand and Supply under Average Climate Change Scenario, 2000–50 ( $km^3$ )

	2000–09	2020–30	2040–50
Total Demand	261	319	393
Irrigation	213	237	265
Urban	28	50	88
Industry	20	32	40
Total Supply	219	200	194
Surface water <sup>a</sup>	171	153	153
Groundwater	48	47	41
Total Unmet demand	42 <sup>b</sup>	119	199
Irrigation	36	91	136
Urban	4	16	43
Industry	3	12	20

Source: FutureWater 2011.

a. Surface water includes river flows into the MENA Region.

b. Summation does not add up due to rounding.

nicipal and industrial water supplies similarly are used inefficiently. In some cities, losses from these supplies reach 30–50 percent, compared to a global best practice benchmark of approximately 10 percent.

Excess demand in all water-using sectors is stoked by perverse and pervasive subsidies. In addition, varying levels of transparency and governance give water agencies and utilities few incentives to improve service standards and promote water conservation. Given the high cost of new water supplies, adding new and more expensive water to such inefficient systems and uses clearly is not economically rational. As water supplies become more limited, there also is the question of water use allocation choices. On the hottest days, irrigation of 1,000 hectares (ha) in MENA consumes the equivalent of the water consumption in a city of 2 million people!<sup>1</sup> Thus, demand management, especially in agriculture, should be the first line of action in any water resources management action plan.

Yet, due to MENA's absolute water scarcity, demand management alone will not solve its ever-growing water scarcity. Even after all demand management options have been fully implemented, there still will be gaps that need to be filled with supply augmentation options. However, conventional supply management options (such as water harvesting and dams) are limited. Nonconventional supply augmentation options (such as reuse of water and wastewater, and desalination of brackish groundwater and seawater) are essential to meet MENA's growing water security needs.

## Water Availability and Demand

For this volume, a combination of detailed hydrological, climate change, and water resources models were developed. They were used to assess the region's current water availability and demand; and the implications of climate change impacts, population growth, and economic and industrial growth on future water supply and demand. A more detailed description of the approach and models used in this volume, and their data limitations, appears in appendix A. The hydrological analysis confirms that per capita renewable water resources in MENA are among the lowest in the world and projects that the situation will worsen in the future (map 2.1 and figure 2.1).

Where the average availability of water per capita is already low, even slight variations can render entire communities unable to cope and create disaster conditions. The Food and Agriculture Organization of the United Nations (FAO) regards levels of total renewable water availability of less than 1,000 m<sup>3</sup> per capita as severe constraints to socioeconomic development and environmental protection. At annual water availability levels of less than 2,000 m<sup>3</sup> per capita, water is regarded as a potentially serious

**MAP 2.1**

**Declining per Capita Water Availability: A Growing Threat in MENA**

a. Average water stress by country, 2000–09



b. Average water stress by country, 2020–30



Source: Modified from FutureWater 2011.

constraint and becomes a major problem in drought years. Based on these criteria,<sup>2</sup> by 2020–30, water availability will be a severe constraint to socioeconomic development in all 21 MENA countries (map 2.1).

Under current conditions (2000–09), countries in the Gulf region face the largest per capita water scarcity in MENA, with an average water availability of less than 300 m<sup>3</sup> per capita per year. As a result of global warming and growing population, water scarcity is projected to become even more severe in the future. Annual per capita water availability in Morocco, for example, will decline from 478 m<sup>3</sup> during 2000–09 to only 76 m<sup>3</sup> in 2020–30 and to 72 m<sup>3</sup> in 2040–50.<sup>3</sup> In total, by 2050, 14 of the 21 MENA countries could have less than 200 m<sup>3</sup> of renewable water resources per capita per year.

**FIGURE 2.1**

**Water Resources Availability and Use in MENA Countries**

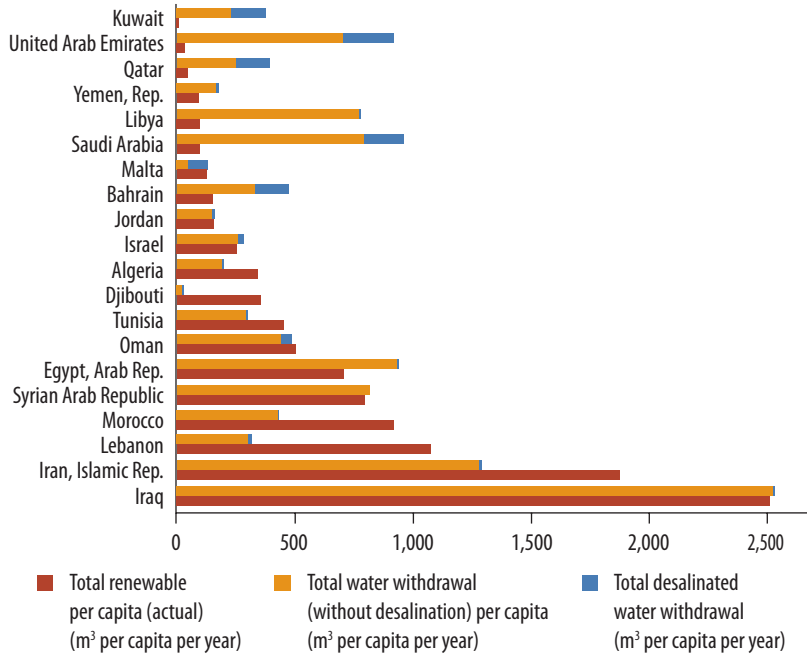

Source: Modified from FAO AQUASTAT 2009.

Note: AQUASTAT is FAO’s global information system on water and agriculture, developed by the Land and Water Division. No relevant FAO data were available for West Bank and Gaza Strip. The Saudi Arabia data were modified based on the GWI desalination database since the FAO data included only desalination figures from the Saline Water Conversion Corporation (SWCC), not the total desalination production capacity in the Kingdom. Total renewable water is based on data between 1960 and 2010; data for Djibouti are unreliable.

**MENA’s Current Water Balance: Already in the Red**

Based on the hydrological analysis, MENA’s current water availability (2000–09 data), including transboundary river flows into the region, is estimated at 219 km<sup>3</sup> per year. Similarly, the modeling exercise in this volume estimates current water demand for MENA Region at 261 km<sup>3</sup> per year (table 2.1).

Based on the above analysis, which used data for 2000–09, the current annual water shortage in the MENA Region is approximately 42 km<sup>3</sup>. However, within that period, year-to-year variations were quite large. Shortages more than doubled from 24 km<sup>3</sup> in 2004 to 64 km<sup>3</sup> in 2008. These variations resulted from the highly erratic local rainfall and fluctuations in the volumes of the major rivers flowing into the region: the Nile, Tigris, and Euphrates.

This already quite substantial unmet demand is a clear reflection of the conditions in most MENA countries. Currently, unmet demand is met

primarily through unsustainably mining fossil aquifers (figure 2.1) and by increasing water supplies through desalination. For example, of the 21 MENA countries covered in this volume, only a few have an average adequate renewable water balance compared to their average water demand. Even the countries that have adequate overall renewable water resources compared to their overall average demand could suffer from water scarcity because moving water from where it is in excess to where it is needed could be cost prohibitive.

Groundwater mining provides a short-term fix to the supply problem. However, without an orderly transition to more sustainable supplies, the danger remains that considerable sections of rural economies could collapse from lack of water. This scenario is particularly serious for the Republic of Yemen, whose aquifers are near exhaustion; and for Oman, whose groundwater mining is causing seawater intrusion and salinization of soils along the Batinah coast.

## **Climate Change Threatens MENA's Future Water Availability**

In this volume, a detailed climate change impacts analysis on water resources has been done for MENA looking at three major scenarios: wet, dry, and most likely average scenario (appendix A). The results indicate that the future water availability for the MENA Region is predicted to decline as a result of global warming. The results also indicate that total renewable water resources will decline significantly as a combined effect of the changes in precipitation and evapotranspiration (ET). It is estimated that, when aggregated over the entire MENA Region, total renewable water resources will decline by approximately 12 percent (equivalent to 47 km<sup>3</sup>) a year (figure 2.2). To contextualize the significance of this impact, today's domestic water demand is approximately 28 km<sup>3</sup> a year.

The results of the hydrological modeling vary considerably so they should be interpreted with care. Transboundary inflows from the Nile, Tigris, and Euphrates are an important component of the region's water balance. Future inflows will be affected not only by climate change and variability but also by the decision of upstream riparians to divert more of the water for their own uses. The values used in this volume are based on the best available data. Future data quality will be better so the volumes of external inflows are likely to be revised. Within MENA as well, countries' water balances will change based on allocations by riparian countries. In addition, for groundwater, the modeling exercise assumes no flow among countries. As more data become available, this assumption may have to be revised.

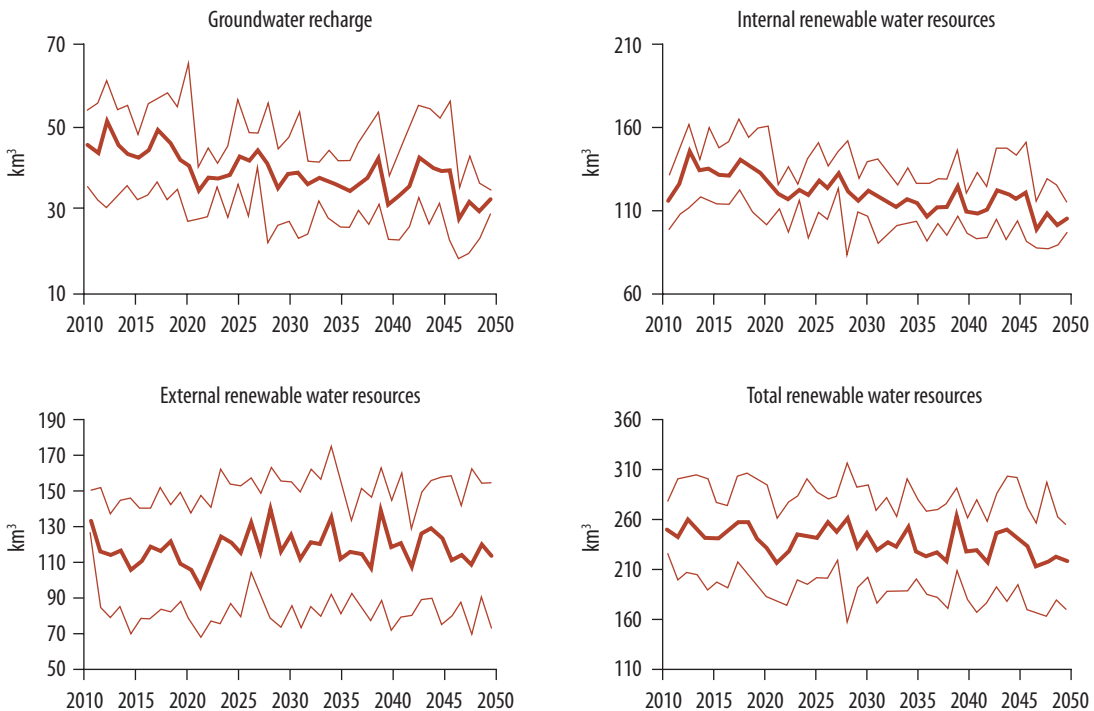
**FIGURE 2.2****Predicted Water Availability in the MENA Region, 2010–50**

Source: FutureWater 2011.

Note: The thick line is the average of the nine general circulation models (GCMs); the thin lines show the second wettest and second driest GCM.

Nonetheless, given that groundwater recharge and internal renewable water resources show a decline under all GCMs, it is safe to assume that water availability overall will decrease in the future. In addition to these longer term trends, MENA countries vary greatly in their hydrological responses to climate change (map 2.2). Most notably, increased precipitation over the southwestern Arabian Peninsula and southeastern Iran probably will increase flood hazards and risks in these areas.

Internal renewable water resources exhibit a negative trend throughout the region, with the exception of central Iran and the Syrian Arab Republic, the southwestern areas of Saudi Arabia and the Republic of Yemen, and Algeria along the area south of the Atlas Mountains. The largest changes are observed in Jordan (–138 percent), Oman (–46 percent), Saudi Arabia (–36 percent), and Morocco (–33 percent). Moreover, groundwater recharge also is predicted to decrease in almost all MENA countries. This projected decrease is generally much stronger than the projected decrease in precipitation because of the nonlinearity of hydrological processes. In relative terms, some of the largest changes in ground-

**MAP 2.2**

**Predicted Changes in Water Availability in the MENA Region, 2010–50**

**a. Precipitation**

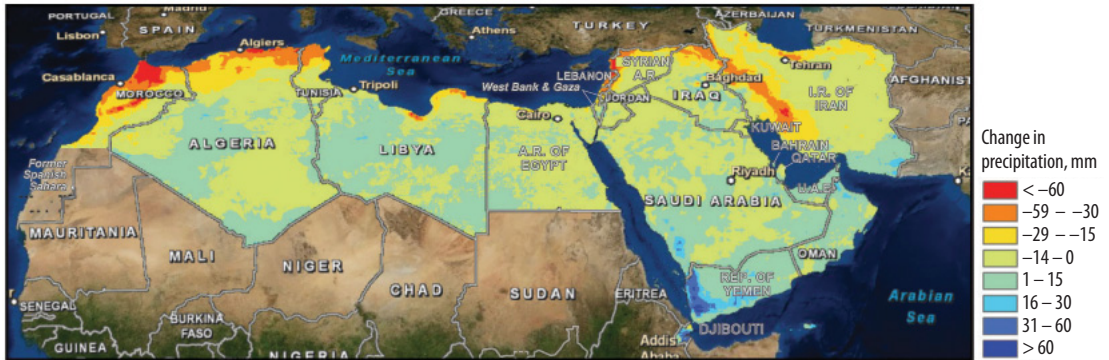

**b. Runoff: Internally renewable water resources**



Source: FutureWater 2011.

water recharge (more than -40 percent) are predicted for the Gulf states, Oman, Saudi Arabia, and the United Arab Emirates. Even in some of the wetter countries, the predicted changes remain very considerable (for example, Morocco -38 percent, Iraq -34 percent, and the Islamic Republic of Iran -22 percent).

**MENA's Future Water Demand: Population and GDP Factor**

**Domestic and Industrial Demand**

Population growth is the primary driver for domestic and industrial water demand. In terms of gross domestic product (GDP) and GDP per capita growth,<sup>4</sup> population and economic prosperity also are assumed to directly drive domestic water demand (figure 2.3). From the baseline period

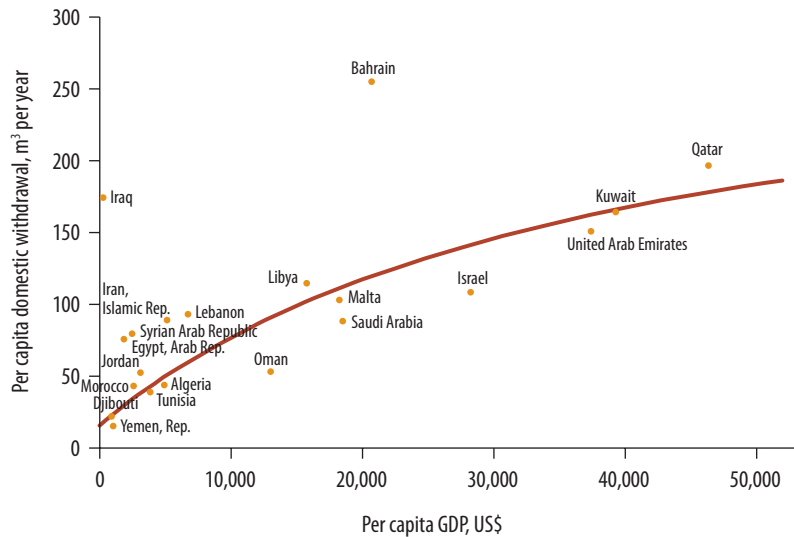
**FIGURE 2.3****Relation between per Capita Domestic Water Withdrawals and GDP per Capita**

Source: FutureWater 2011.

2000–09, current annual MENA domestic water demand is estimated at  $28 \text{ km}^3$ . From the same baseline, current MENA industrial water demand is estimated to be  $20 \text{ km}^3$  a year.

According to the Center for International Earth Science Information Network (CIESIN and YCELP 2002), MENA's population will grow from 316 million in 2000 to 697 million in 2050. The Arab Republic of Egypt and the Republic of Yemen will have the largest population increases. For the same period, regional GDP is projected to grow from its current US\$1.6 trillion to US\$6.5 trillion by 2030–40, and reach US\$19 trillion by 2040–50 (appendix A). Based on these assumptions, future domestic water demand will grow to  $50 \text{ km}^3$  by 2030–40, and to  $88 \text{ km}^3$  by 2040–50. Similarly, MENA's industrial water demand is projected to double by 2050 from today's  $20 \text{ km}^3$  a year to  $32 \text{ km}^3$  a year by 2030–40, and to  $41 \text{ km}^3$  a year by 2040–50.

### Irrigation Demand

The distribution of current irrigated areas across the MENA Region was determined from an analysis of satellite imagery by FAO and Kassel University supplemented by an extensive FAO database collated from MENA countries' statistical offices (FAO 2006; Siebert and others 2007). Released in 2007, the map shows the proportion of area equipped for irrigation approximately in year 2000.<sup>5</sup> Major irrigation areas in MENA, in-



### MAP 2.3

#### Distribution of MENA Areas Equipped for Irrigation, 2000

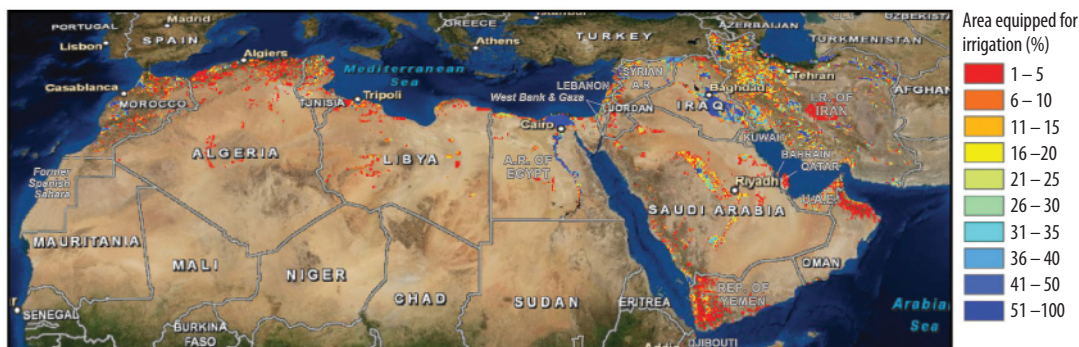

Source: Siebert and others 2007.

cluding the Nile delta in Egypt, areas along the Euphrates and Tigris Rivers in Iraq, northern Iran, central Saudi Arabia, western Republic of Yemen, Oman's Batinah coast, and the Sebou and Oum el Rbia systems in Morocco, are shown in map 2.3. Not all equipped area is actually irrigated, and within most countries, the irrigated area varies annually.

At the turn of the twenty-first century, the total irrigated area in MENA was approximately 21 million ha. The corresponding irrigation water demand was approximately 213 km<sup>3</sup> per year.<sup>6</sup> Seven countries accounted for 90 percent of MENA's irrigated area, and two countries—the Islamic Republic of Iran and Iraq—accounted for 50 percent. Currently, irrigation accounts for 81 percent of all water demand in the MENA Region.

Future irrigation demand was determined by irrigation potential,<sup>7</sup> defined in this volume as the difference between the currently irrigated area and the total irrigable land for which renewable water resources are available (appendix A). Generally, irrigation potential is constrained by renewable water resources. However, in many arid countries, irrigation is sustained through mining fossil groundwater reserves. This activity is particularly prevalent in Jordan, Libya, Saudi Arabia, the United Arab Emirates, and the Republic of Yemen. Through depleting the aquifers, the area under irrigation can exceed the irrigation potential.

Given these constraints, irrigation water demand is projected to increase by 2050. If global warming induces a wetter and warmer climate, irrigation water demand will increase by 15 percent over current demand (table 2.2). Conversely, if the future climate is warmer and drier, irrigation demand is expected to increase by 33 percent. Under the most likely (average) trend, demand will increase by approximately 25 percent.

While climate change will modestly affect irrigation water demand, it will have a far greater impact on water resources. If the climate turns out

**TABLE 2.2****MENA Irrigation Water Demand ( $km^3$  per year and percent increase over current demand)**

Climate scenario	Average	Dry	Wet
Current 2000–09	213	—	—
2020–30	237 (+11%)	254 (+19%)	222 (+4%)
2040–50	265 (+24%)	283 (+33%)	246 (+15%)

Source: Adapted from FutureWater 2011.

Note: — = not available.

to be drier than present, renewable water resources could be reduced by more than 40 percent.

**Future Water Balance: The Gap Grows**

In the future, MENA's water shortage will increase substantially under all climate change scenarios because of increased demand and reduced supply. If the climate follows the predicted average trend, the water shortage will grow from the current 42  $km^3$  per year to 199  $km^3$  per year by 2040–50, which is approximately five times the current demand gap (table 2.3). However, if the dry climate scenario occurs, the demand gap will reach 283  $km^3$  per year—or more than all current regional water demand. Even under the wet climate scenario, in the longer term, the demand gap will increase. Compared with today, by 2050 the demand gap will double to 85  $km^3$  per year.

An important point is that the average for any period masks considerable interannual climate variation. For instance, as noted earlier, the aver-

**TABLE 2.3****MENA Water Demand Gap under Three Climate Scenarios, 2000–50 ( $km^3$  per year)**

Climate scenario	2000–09	2020–30	2040–50
Average			
Total demand	261	319	393
Demand gap	42 (16%)	119 (37%)	199 (51%)
Dry			
Total demand		336	412
Demand gap		199 (56%)	283 (69%)
Wet			
Total demand		303	375
Demand gap		42 (14%)	85 (23%)

Source: Adapted from FutureWater 2011.

age annual variation in the supply gap for 2000–09 was 42 km<sup>3</sup>. However, the variations ranged from 24 km<sup>3</sup> in 2004 to 64 km<sup>3</sup> in 2008. When designing future supply augmentation responses, considerable care will be needed to include this interannual uncertainty around the predicted trends and to provide sufficient capacity and storage to meet the impact of droughts.

### Assessment of Individual Countries

This volume assessed the impact of change in climate, and irrigation, and domestic and industrial demand separately for the 21 MENA countries. The total water demand and unmet demand for each country also were assessed (table 2.4). Demand will increase for all countries as a result of the higher evaporative demand of irrigated agriculture and the increase

**TABLE 2.4**

### Current and Future Water Demand and Unmet Demand Gap under the Average Climate Change Projection (km<sup>3</sup>)

Country	Demand			Unmet		
	2000–09	2020–30	2040–50	2000–09	2020–30	2040–50
Algeria	6,356	8,786	12,336	0	0	3,947
Bahrain	226	321	391	195	310	383
Djibouti	28	46	84	0	0	0
Egypt, Arab Rep.	55,837	70,408	87,681	2,858	22,364	31,648
Iran, Islamic Rep.	74,537	84,113	97,107	8,988 <sup>a</sup>	21,767	39,939
Iraq	50,160	67,235	83,803	11,001 <sup>a</sup>	35,374	54,860
Israel	2,526	3,396	4,212	1,660	2,670	3,418
Jordan	1,113	1,528	2,276	853	1,348	2,088
Kuwait	508	867	1,216	0	313	801
Lebanon	1,202	1,525	1,869	141	472	891
Libya	4,125	4,974	5,982	0	1,382	3,650
Malta	45	62	75	0	22	36
Morocco	15,739	19,357	24,223	2,092	9,110	15,414
Oman	763	1,091	1,709	0	24	1,143
Qatar	325	381	395	83	209	246
Saudi Arabia	20,439	22,674	26,633	9,467	14,412	20,208
Syrian Arab Republic	15,311	17,836	21,337	323	3,262	7,111
Tunisia	2,472	3,295	4,452	0	0	837
United Arab Emirates	3,370	3,495	3,389	3,036	3,243	3,189
West Bank and Gaza	460	680	1,022	308	591	925
Yemen, Rep.	5,560	7,069	12,889	1,120	2,573	8,449
MENA	261,099	319,138	393,082	42,125	119,443	199,183

Source: Adapted from FutureWater 2011.

a. Current unmet demand gaps for Iraq and the Islamic Republic of Iran are estimated, respectively, at 11 km<sup>3</sup> and 9 km<sup>3</sup>. Intuitively, these gaps look unrealistic for countries that normally have positive national level water balance. These gaps can be explained by the sustained drought experienced in the two countries in the last decade. Similarly, the current demand gap of zero for Djibouti, Kuwait, Libya, and Malta—especially the figure of zero demand gap for Djibouti until 2050—can be explained by (a) the generalized national water balance approach used in the hydrological analysis and (b) the extremely poor and unreliable data quality for some of the countries. For example, for Djibouti, although, in reality, the country suffers from chronic water shortage, every database, including FAO's AQUASTAT (2009) shows the opposite.

in domestic and industrial needs. Overall, from the 2009 baseline, this demand will increase by approximately 25 percent in 2020–30, and by approximately 60 percent in 2040–50. However, large variation occurs when countries with relatively high domestic and industrial demand show larger proportional increases compared to other countries. The larger countries with extensive agricultural demands account for the major share of the increased future demand.

The growth of the demand gap will be dramatic for all countries. Countries that currently face no or limited water shortages will be confronted with large water deficits in the near and distant future. For example, Egypt, the Islamic Republic of Iran, Iraq, Morocco, and Saudi Arabia will see their annual water shortages increase by 10–20 km<sup>3</sup> in 2020–30, and up to 20–40 km<sup>3</sup> in 2040–50. While the magnitude of the water gap in the least stressed countries looks relatively small compared with the huge gap for Iraq in 2040–50, the challenge of meeting their water gaps appears formidable.

Uncertainty in these predicted country deficits was determined by analyzing dry and wet climate projections. Changes in total demand as a function of climate change are modest compared with the increase in water shortage caused by changes in water supply. In Egypt, with its very climate-sensitive Nile basin as the single water source, water will be short by 50–60 km<sup>3</sup> per year according to the dry projections, but there will be no real shortage in the case of the wet projection. For other countries, the differences among the climate projections are more modest. For example, in Morocco, the annual difference in expected water shortage in 2040–50 ranges from 8 km<sup>3</sup> for the wet climate to 20 km<sup>3</sup> for the dry climate, and 15 km<sup>3</sup> per year for the average climate projection. Other countries show a similar behavior.

The only alternative options to close the growing water demand gap are better management of available water and finding new sources of supply. The next section discusses options for demand management. Desalination of seawater and brackish water, increased reservoir capacity, and reuse of wastewater, among others, constitute supply-side management options. Some of these are discussed in the next section and some in the following chapters.

## **Imperative for Demand and Supply Management**

In many MENA countries, conventional supply options are reaching their physical and financial limits. Therefore, improved water management is essential. This necessity is forcing a transition from focusing on augmenting supply and providing direct service to concentrating on

water management and regulation of services. These changes are helping governments take into account the entire water cycle rather than its separate components. Governments are using economic instruments to allocate water according to principles of economic efficiency and are developing systems that have built-in flexibility to manage variations in supply and demand. The changes include planning that integrates water quality and quantity and considers the entire water system; promotes demand management; reforms tariffs for water supply, sanitation, and irrigation; strengthens government agencies; decentralizes responsibility for delivering water services to financially autonomous utilities; and more strongly enforces environmental regulations. A more detailed summary on demand side and supply side management is presented in appendix B.

### Institutions Matter

Although noticeable progress has been made, given the scale of water scarcity in the region and the potential for improvement, water management remains a problem in most MENA countries (World Bank 2007). Water is still being allocated to low-value uses even while higher-value needs remain unmet. Service outages for water supply services are common, even in years of normal rainfall. People and economies remain vulnerable to droughts and floods. Despite the region's huge investments in piped water supply, many countries experience poor public health outcomes. Over-extraction of groundwater is undermining national assets at rates equivalent to 1–2 percent of GDP every year in some countries (figure 2.4).

**FIGURE 2.4**

#### Value of Groundwater Depletion in Selected MENA Countries as a Share of GDP

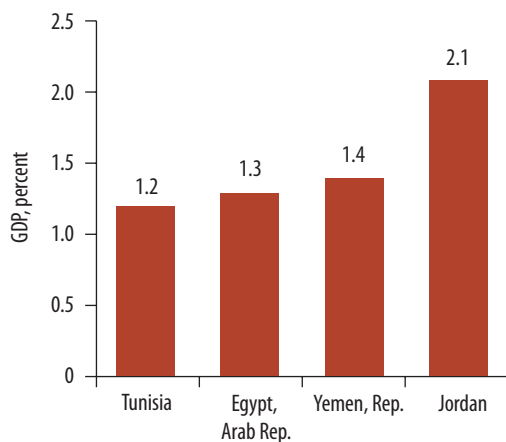

Source: World Bank 2007 after Ruta 2005.

## **Demand Management**

### ***Agricultural policy reform***

In most MENA countries, food security has been a major concern, particularly for staples, such as wheat. Wheat comprises an exceptionally high 44 percent of the region's total food supply (CGIAR 2011). This desire for food security not only has driven substantial government investment in irrigation systems but also has led to subsidies of inputs (such as pumps, irrigation technology, and electricity) and of outputs through price support mechanisms.

Given the increasing populations who depend on a fixed amount of water, in the future, trade will become even more important for water management. Due to geopolitical tensions, rural employment, and food security concerns, countries will aim to increase their food self-sufficiency. At present, they achieve food security only when local production is supplemented through trade. Fortunately, most MENA countries are geographically near enough to meet European demand for off-season fruits and vegetables. If they devise progressive agricultural policies, these countries could grow more of the crops that are their comparative advantage to export, while increasing imports of lower-value staples, thus optimizing their virtual water balance.

Saudi Arabia is one of the most striking examples of how reforming agricultural policies can significantly reduce water demand. In the 1970s, Saudi Arabia started subsidizing wheat production using fossil groundwater. By the late 1980s, wheat production was high enough to make Saudi Arabia the world's sixth largest wheat exporter, competing in the international market against rain-fed wheat (Abderrahman 2001; Wichelns 2005). However, realizing that the country's fossil groundwater was rapidly being depleted, beginning in 1993, the government invoked a series of measures to reduce wheat price support. Subsequently, the country's annual agricultural water demand continued to decline from its peak of 23 km<sup>3</sup> in the mid-1990s to an estimated 14 km<sup>3</sup> in 2010. It is anticipated that by 2014 Saudi Arabia's annual groundwater demand will drop below 10 km<sup>3</sup>. Nevertheless, irrigated fodder production, which has similarly low returns to water, still uses 25 percent of the groundwater resources.

The United Arab Emirates had similar groundwater mining problems caused by irrigated fodder crops. In 2010, the United Arab Emirates eliminated subsidies for irrigated Rhodes grass (grown for animal feed). The government estimates that this action will reduce agricultural water consumption by 40 percent between April and September, the hottest months of the year (*National* 2010).

**Improving efficiency of water allocation and use**

Currently, MENA’s average agricultural water use efficiency languishes at 50–60 percent. Pursued vigorously, improved scheduling, management, and technology could increase its efficiency to the level of the best managed areas of arid Australia and the United States that have water use efficiencies higher than 80 percent. Similarly, due to poor intersectoral allocation, some countries do not have enough water to service export agriculture, leading to dramatic reduction in production during dry periods (Humpal and Jacques 2003). Thus, improving unreliable water supply through better scheduling, management, and technology would make better use of sunk investments, which then could be used more productively—generating higher income per drop (figure 2.5).

Developing a system for tradable water rights is another critical component in the overall water resources management. Fortunately, in most MENA countries, traditional surface water resources—perennial rivers and seasonal flood flows (*afraj* systems) in Egypt, the Islamic Republic of Iran, Iraq, Morocco, Syria, and the Republic of Yemen—have long-established water rights. Even when these have been modified by large modern surface water diversions, as in Egypt, the Islamic Republic of Iran, and Iraq, new and workable systems of water rights and allocation procedures have been established successfully. However, the same cannot be said of groundwater access, which is riddled with perverse incentives that encourage unsustainable use.

**FIGURE 2.5**

**High-Tech Agricultural Packages Increase Water Use Efficiency (kg production per m<sup>3</sup> water)**

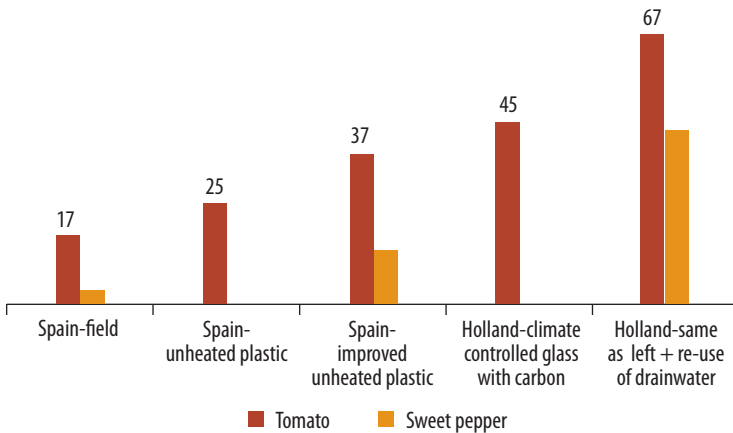

Source: ICBA 2010.

### ***Reducing perverse incentives***

In addition to affecting agricultural input and output support, perverse incentives particularly negatively affect the use of groundwater, the basis of most irrigation in the MENA Region. The particular challenges, especially for the lower income countries, are managing groundwater extraction to avoid exhausting the resource and managing agricultural trade. As with crude oil and gas, extracting nonrenewable groundwater involves trade-offs between current and future use of the finite resource.

Due to excessive subsidies, groundwater is priced very low and its use is made inexpensive. Even with realistic energy pricing, the cost of groundwater production does not represent its actual value to society. As noted above, fossil groundwater is a finite resource and, once gone, is irreplaceable. When farmers run out of fresh or moderately brackish groundwater, they typically have two choices: stop using water, or use an alternative resource. The only viable alternative source of water is desalinated water. Thus at the margin, desalinated water is the alternative to fresh groundwater. In economic terms, the opportunity cost of groundwater is the same as its substitute, desalinated water. Consequently, the marginal cost of fresh or moderately brackish groundwater is US\$1.5–2.1 per cubic meter (chapters 4 and 5) depending on the location in MENA and the desalination technology adopted.

Groundwater priced near these levels would provide a strong incentive to use fresh water efficiently and to use it only on high-value crops. In MENA, however, in practice, groundwater pricing has proved extremely difficult to implement due to the political difficulty of giving ownership or water rights to individuals and allowing these rights to become tradable. This task is made even more difficult by the generally poor ability to quantify groundwater resources and sustainable use levels. The scale of individual actions to tap into groundwater also often overwhelms the ability of governments to control them, even with such approaches as licensing new wells. The Republic of Yemen is a particularly egregious example. The result is that, across the region, aquifers are being used beyond sustainable levels. Experience in the region suggests that, in MENA, it might be easier to establish water-trading institutions to obtain supplemental supplies (desalination, interbasin transfers) than to reform institutional arrangements and historical property rights on a large scale (World Bank 2007). This experience could provide insights on how to adapt the market over time and scale it up to a broader application.

### ***Managing domestic water demand***

This will be aimed primarily at reducing loss<sup>8</sup> of water on the supply side and reducing excessive consumption on the demand side. Reducing water



losses is important because consumers are paying for water utilities' inefficiencies, the waste of a precious and scarce resource, and unnecessary investments in production. Most government-managed water supply utilities in MENA have water losses that exceed 30 percent. In comparison, international best practice for a well-managed utility is approximately 10 percent water loss (World Bank 2007). Based on MENA's 2010 domestic water demand of 28 km<sup>3</sup>, water resources demand could be decreased by as much as 5.6 km<sup>3</sup> a year if water losses were reduced to best-practice levels.

Per capita water consumption for domestic uses could be substantially reduced if the appropriate incentive structures were introduced. International experience is that, after physical improvements (such as reducing leaks and installing more efficient plumbing appliances), administrative and pricing instruments are the most effective means to reduce wasteful household consumption. These instruments have conserved water in Australia, Canada, England, and Wales. Most of their populations live in nondesert climates; their water tariffs are near the cost of producing and distributing potable water; and their billing, collection, and disconnection policies are robust.

Many MENA governments still are the primary service providers so they have few incentives to conserve water. Worse, due to low water tariffs, they frequently raise insufficient revenues to properly maintain and operate the water distribution systems, exacerbating nonrevenue water losses.

### **Conventional Supply Management Options Are Limited**

Rainwater harvesting and check dams in wadis generally are very small scale and very local in application.<sup>9</sup> Typically, they provide drinking water and groundwater recharge to single households or small communities. From a regional perspective, these two sources can only slightly augment supply, except in rural areas.

Dams to impound larger volumes of water have limited potential in the MENA Region. In relation to the freshwater available, MENA's rivers are the most heavily dammed in the world. More than 80 percent of the region's surface freshwater resources are stored behind reservoirs (World Bank 2007). Consequently, limited potential exists to expand water availability through constructing new dams. Some potential does exist, particularly in the more humid parts of the region such as northwestern Iran and the Atlas Mountains in Algeria and Morocco. Elsewhere, in the more arid MENA countries, the highly uncertain rainfall amounts and frequency frustrate reliance on reservoirs for assured supplies, a situation made worse by the likelihood of lower precipitation in the future.

## Unconventional Supply Management Options Are Essential

Wastewater reuse, including irrigation water reuse, and desalination of brackish groundwater and seawater, holds significant potential to bridge the water demand gap in MENA. Some countries in the region have significant brackish groundwater reserves. These could be used to support salt-tolerant agriculture and/or be a source of desalinated water. Recycled wastewater is an assured resource and the only one that is guaranteed to increase in correlation with population growth. Given that actual consumption of water by drinking, cooking, and washing accounts for only approximately 10 percent of domestic demand, the potential for wastewater reuse is large. For example, if only 50 percent of this potential wastewater were recycled, it could add approximately 22 km<sup>3</sup> per year to MENA's renewable water resources by 2030, and as much as 40 km<sup>3</sup> per year by 2050. These increases would be driven first by population growth, second by extension of wastewater collection and treatment networks, and third by peoples' acceptance of its use.

International experience suggests that building public acceptance is central to the success of beneficially using treated wastewater. Costs, policies, laws, and institutions including regulatory functions that ensure strict implementation of the laws governing the full cycle of wastewater reuse are additional critical components. Regarding cost, it is important for treatment strategies to take into account the effluent quality criteria required by different reuse applications, as these criteria are the major determinants of the costs (figure 2.6). Cost also will be increased by the need for distribution systems. Many MENA countries require that re-

**FIGURE 2.6**

### Cost Range for Water Reuse

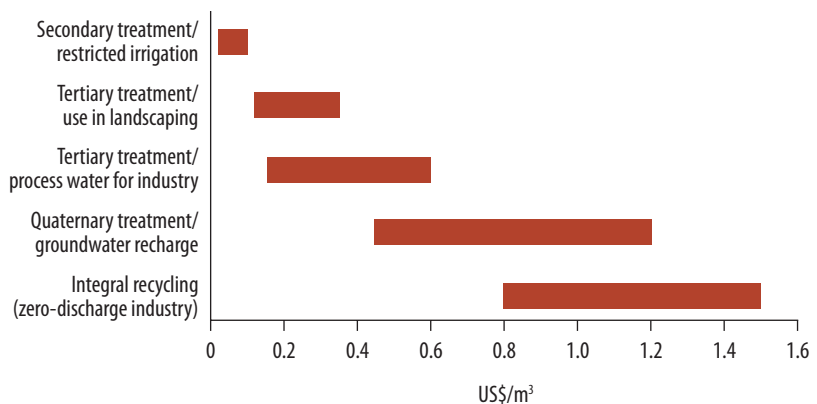

Source: Adapted from Labre 2009.

Note: Excludes water distribution costs.

cycled water be kept separate from potable water distribution systems. When recycled water is used for urban landscaping, distribution costs can be reduced. Cost probably would not be reduced for recycled water for agriculture, which could require transmission over considerable distances.

Finally, desalinated seawater (or brackish water) is available near most of MENA's population centers. The constraints are its relatively high cost, dependence on high energy inputs, and safe brine disposal. Being the main theme of this volume, this topic is discussed in detail in the chapters that follow.

## Notes

1. Assuming ET of 10 mm per day, this is equivalent to 100,000 m<sup>3</sup> per day. However, since water use efficiency is only 50 percent, the required volume is 200,000 m<sup>3</sup> per day. If the average domestic consumer uses 100 liters per day, this is equal to the total water demand of 2 million people.
2. Water scarcity is a relative concept. It is partly a "social construct" in that it is determined by both the availability of water and consumption patterns.
3. This estimate is based on future population and GDP growth projected for Morocco by CIESIN; FAO 2006; and the IPCC's 2007 climate change projection (AR4), which estimated a decrease in water availability of approximately 33 percent by 2050.
4. If a country produces more GDP in line with population growth, it is assumed that industrial water demands will grow at the same rate as GDP. However, if GDP grows faster than the population growth, it is assumed that a richer and more sophisticated population will introduce more efficient and environmentally sustainable industrial water use and thus will slow the growth of industrial water demand below the rate of GDP growth.
5. The entire MENA Region was divided into a grid with a resolution of 5 minutes of arc (approximately equivalent to a 10 km × 10 km grid).
6. Irrigated area was assessed by FAO AQUASTAT using country-derived data covering 1996–2007. There is no consistent set of Regional irrigation data for any one year.
7. However, methods to compute irrigation potential vary from one country to another, and there is no homogeneous assessment of this indicator across MENA countries. The concept of irrigation potential also is not static. It varies over time in relation to the country's economic circumstances or as a result of increased competition for water for domestic and industrial use.
8. "Losses" in this context also are called "nonrevenue water" or "unaccounted-for-water." All three terminologies include physical losses from leaky pipes, losses due to unauthorized tapping of water pipelines, and losses due to unbilled water that may or may not be metered. It should be noted that for water use efficiency purposes, system losses are more important than NRW/UFW.
9. A *wadi* is a dry valley, gully, or streambed. During the rainy season, the same name is given to the stream that runs through the wadi.

## References

- Abderrahman, W. A. 2001. "Water Demand Management in Saudi Arabia." In *Water Management in Islam*, ed. N. I. Faruqui, A. K. Biswas, and M. J. Bino, 68–78. Tokyo: United Nations University Press.
- CGIAR (Consultative Group on International Agricultural Research). 2011. "Research and Impact: Areas of Research: Wheat." Washington, DC. <http://www.cgiar.org/impact/research/wheat.html>.
- CIESIN (Center for International Earth Science Information Network) and YCELP (Yale Center for Environmental Law and Policy). 2002. *Country-Level Population and Downscaled Projections Based on the A1, A2, B1, and B2 Marker Scenarios, 1990–2100* (digital version). Palisades, NY: CIESIN, Columbia University. <http://www.ciesin.columbia.edu/datasets/downscaled>.
- FAO (Food and Agriculture Organization of the United Nations). 2006. *World Agriculture: Towards 2030/2050: Prospects for Food, Nutrition, Agriculture and Major Commodity Groups. Interim Report*. Rome: Global Perspectives Studies Unit. [http://www.fao.org/fileadmin/user\\_upload/esag/docs/Interim\\_report\\_AT2050web.pdf](http://www.fao.org/fileadmin/user_upload/esag/docs/Interim_report_AT2050web.pdf).
- FAO (Food and Agriculture Organization of the United Nations). 2009. AQUASTAT. <http://www.fao.org/nr/water/aquastat/main/index.stm>.
- FutureWater. 2011. *Middle-East Northern Africa Water Outlook. Final Report*, commissioned by the World Bank, W. Immerzeel, P. Droogers, W. Terink, J. Hoogeveen, P. Hellegers, and M. Bierkens (auth.). Future Water Report 98, Wageningen, the Netherlands. [www.worldbank.org/mna/watergap](http://www.worldbank.org/mna/watergap).
- Humpal, D., and K. Jacques. 2003. "Draft Report on Bumpers and Import Sensitivity Analysis for Moroccan Table Olives and Olive Oil." Prepared for USAID (United States Agency for International Development) under the Raise Sanitary and Phytosanitary Services (SPS) contract with financing from the Middle East Partnership Initiative (MEPI). [http://pdf.usaid.gov/pdf\\_docs/PNACX907.pdf](http://pdf.usaid.gov/pdf_docs/PNACX907.pdf).
- ICBA (International Center for Biosaline Agriculture). 2010. *Wastewater Strategy for Abu Dhabi*. Dubai, United Arab Emirates: ICBA.
- Labre, J. 2009. Quoting a report on "Water Reuse Markets 2005–2015," published by GWI (Global Water Intelligence).
- National*. 2010. "End to Subsidy for Farmers' Rhodes Grass." Abu Dhabi. September 28. <http://www.thenational.ae/news/uae-news/environment/end-to-subsidy-for-farmers-rhodes-grass>.
- Siebert, S., P. Doll, S. Feick, J. Hoogeveen, and K. Frenken. 2007. *Global Map of Irrigation Areas*. Version 4.0.1. Land and Water Digital Media, Series 34. Frankfurt am Main: Johann Wolfgang Goethe University; Rome: Food and Agriculture Organization of the United Nations. <http://www.fao.org/nr/water/aquastat/irrigationmap/index10.stm>.
- Wichelns, D. 2005. "The Virtual Water Metaphor Enhances Policy Discussions Regarding Scarce Resources." *Water International* 30 (4): 428–37.
- World Bank. 2007. *Making the Most of Scarcity: Accountability for Better Water Management Results in the Middle East and North Africa*. MENA Development Report. Washington, DC: World Bank. [http://siteresources.worldbank.org/INTMENA/Resources/Water\\_Scarcity\\_Full.pdf](http://siteresources.worldbank.org/INTMENA/Resources/Water_Scarcity_Full.pdf).

## Closing MENA's Water Gap Is Costly and Challenging

The widening gap between the demand and supply of water seriously threatens the sustainable growth of the MENA Region. Lack of water of sufficient quantity and quality affects economic growth, food security, employment opportunities, and overall quality of life in urban and rural areas. Inadequate potable water supplies also can contribute to or cause conflicts over water. To maintain healthy and sustainable growth, the burgeoning water demand gap in the region must be closed.

Key approaches to meet the water scarcity challenge include rational management and use of available water resources and augmentation of water supplies. Best practices combine both elements in an integrated approach to water resources management. However, solutions to deal with water scarcity for each country or city will vary due to different local circumstances.

Ideally, demand and supply management decisions are based on the planning objective of maximizing the net economic, environmental, and social benefits to the society as a whole. While this objective can be readily applied by individual countries, it is exceedingly difficult to apply by all 21 MENA countries combined because views within the region diverge widely on which environmental and social benefits should be given priority in planning water resources development. Consequently, this volume adopts the least-cost principle as the first step to identify which demand and supply management options could be adopted in the regional water strategy. The study also placed a high priority on reducing unsustainable groundwater mining. It will be the task of later detailed follow-up studies at the country level to include local costs and benefits, and country-specific priorities that may not necessarily be cost related that will define more explicitly country water strategies to close the water gap.

## Strategic Approach

Each country will have its own least-cost adaptation strategy depending on its water resources endowment and current levels of use and efficiency, and the physical viability of alternative tactics to fill its water gap. Many choices are available to planners and decision makers, but for simplicity this volume selected nine tactical options. They are classified into three major operational areas.

### *Increasing water productivity through:*

1. Improved agricultural practice (including crop varieties)
2. Increased reuse of water from domestic and industrial uses
3. Increased reuse of water in irrigated agriculture.

### *Expanding supply:*

4. Expanding reservoir capacity (small scale)
5. Expanding reservoir capacity (large scale)
6. Desalination by means of fossil fuel
7. Desalination by means of renewable energy.

### *Reducing demand:*

8. Reduce irrigated areas<sup>1</sup>
9. Reduce domestic and industrial demand of water supply.

Each tactical option at the country level will produce some additional water for a specific cost (figure 3.1). The width of the block in figure 3.1 represents the volume of water that will become available from adopting a specific option. The wider the column, the larger its net impact on water availability. The height of the block represents its annualized unit cost in 2010 US\$ per m<sup>3</sup>, which includes capital cost and net operating cost. Generally, again for simplicity, it is assumed that the least expensive option will be fully utilized first. The total annual costs for the combined set of options can be calculated by multiplying the specified deficit by the unit cost of each block required to close the water gap.

This approach builds on the methodology developed by the 2030 Water Resources Group (2009). The method involved applying each relevant option sequentially at the country level and determining the net impact of each measure on water availability, taking into account return flows and at what point in the system they occur. This hydrological systems approach is especially important, for example, for drip irrigation, which can have significant efficiency impacts at the farm level but may reduce water availability for users downstream who rely on return flows. On the other hand, upstream efficiency improvements in irrigation may reduce waterlogging in downstream areas of irrigation schemes.

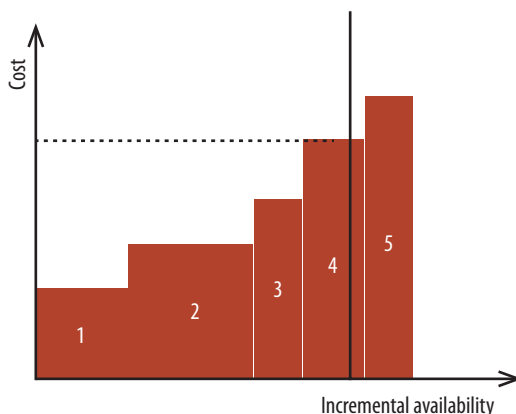
**FIGURE 3.1****Schematic Representation of Marginal Water Cost Curve**

Source: FutureWater 2011.

Note: Vertical line crossing box 4 shows the water gap, for example, in 2030, and the horizontal dotted line shows the investment required to close the water gap.

The marginal cost-curve approach provides information on the potential cost of adopting a set of tactical options that comprise the strategy to close the demand gap, which in turn could be used to inform policy design. The tactical approach does not include or evaluate policies, such as pricing, standards, and behavioral changes, that would be used to enable, incentivize, or enforce the adoption of these options.

In practice, cost is not the only basis on which choices are made. The least costly alternative may not be used first because of the need for extensive consultation or other considerations. For example, water from a new dam may be relatively inexpensive, but the long lead time to meet environmental management concerns may preclude its effectiveness for several years. Similarly, building local water user institutions to implement improved water use efficiency interventions may take several years. Finally, the least-cost approach to securing water supply does not seek to decommission environmentally unfriendly water supply infrastructure. If large traditional fossil fuel-powered desalination plants have considerable economic life remaining, few governments would abandon them for cheaper and more environmentally friendly technology.

Bearing in mind these limitations, shedding light on the cost and technical potential of tactical options enables these measures to be compared and evaluated in a common context. The cost curve, then, is not prescriptive: it does not represent a fixed plan for closing the supply-demand gap. Rather, it is a tool to help decision makers understand

and compare different options to close the unmet gap under a given demand scenario.

## Unit Costs of Tactical Options

The unit cost of each measure in the future is uncertain, and they are likely to differ by country. These difficulties are discussed in detail below.

- *Improve agricultural practices.* Unit cost: US\$0.02 per m<sup>3</sup>. There are various kinds of improved agricultural practices, such as drip and sprinkler irrigation, no-till farming and improved drainage, utilization of the best available germplasm or other seed development, optimization of fertilizer use, innovative crop protection technologies, and extension services. Costs of such measures vary but, compared to the water supply measures, are relatively inexpensive. Some productivity measures even result in a net cost savings when operating savings of the measures outweigh annualized capital costs. The majority of unit costs of such measures range from US\$0.02 per m<sup>3</sup> to 0.03 per m<sup>3</sup> (2030 Water Resources Group 2009). Converting this range to costs per hectare (ha) (assuming approximately 10,000 m<sup>3</sup> of water consumption per ha) results in US\$200–300 per ha per year. Obviously, these costs can vary and are measure dependent. For example, for the Irrigation Improvement Project (IIP) in the Arab Republic of Egypt, the average improvement costs exceeded LE 6,000 per Feddan, or approximately US\$2,500 per ha.<sup>2</sup> Taking into account depreciation costs on investment of 25 years gives annualized capital costs of approximately US\$100 per ha.
- *Increase reuse of domestic and industrial water.* Unit cost: US\$0.30 per m<sup>3</sup>. Cost depends on the treatment level. The unit cost of municipal and industrial wastewater reuse is on average US\$0.30 per m<sup>3</sup> (2030 Water Resources Group, 77, Exhibit 24).
- *Increase reuse of irrigation water.* Unit cost: US\$0.04 per m<sup>3</sup>. These costs are relatively low as it was assumed that this water is reused only for agricultural purposes so that no additional treatment is necessary (2030 Water Resources Group, 75, Exhibit 23).<sup>3</sup> The estimated cost is based on the reuse of 50 mm (equivalent to 500 m<sup>3</sup> per ha per year). Reuse will require an investment cost of US\$1,000 per ha equivalent to an annualized cost over 10 years of US\$0.02 per m<sup>3</sup> plus annual operational costs for maintenance and pumping of US\$0.02 per m<sup>3</sup>.
- *Expand reservoir capacity—small scale.* Unit cost: US\$0.03 per m<sup>3</sup>. Obviously, these costs can vary among regions. For example, according to



Di Prima (2007), who reviewed experience with sand dams in Kituri District, Kenya, their construction cost is relatively high: currently approximately US\$10,000 for each dam to provide an average of 5,000–8,000 m<sup>3</sup> of water each season for (potentially) 50 years or more. The cost in this case was US\$0.04 per m<sup>3</sup>.

- *Expand reservoir capacity—large scale.* Unit cost: US\$0.05 per m<sup>3</sup> for large-scale infrastructure (2030 Water Resources Group, 48, Exhibit 7). The Aslantas Dam in Turkey is an example of a large dam. The annual recovery charge on investment in the Aslantas Dam is estimated at US\$350 per ha per year. Assuming 1,000 mm per year additional water storage per ha (10,000 m<sup>3</sup> per ha) results in US\$0.035 per m<sup>3</sup> (WCD 2000).
- *Desalination using conventional energy.* Energy use is significantly subsidized in the MENA Region and current costs of electricity (or steam) cannot represent the economic cost of desalination. Instead, the opportunity cost of fossil fuel (that is, forgone revenue from fuel sale at international price) has been assumed in this volume. The resulting unit costs of US\$1.3 per m<sup>3</sup> in 2010, increasing to US\$2.5 per m<sup>3</sup> by 2050, were used.<sup>4</sup> Approximately half of the costs of desalination consist of energy costs (Trieb and others 2011). However, due to the volatility of fossil fuel prices and development of technological breakthroughs for conventional energy sources, there is uncertainty about, among others, both future energy prices and energy requirements.
- *Desalination using renewable energy.* Unit cost: Initially US\$1.8 per m<sup>3</sup>; by 2050, expected to fall<sup>5</sup> to US\$0.9 per m<sup>3</sup> (Trieb and Müller-Steinhagen 2008; Trieb and others 2011).<sup>6</sup> Renewable energies (such as concentrating solar power [CSP]) could be used as substitutes to generate energy. The volatility of the oil market and projected future increases in oil prices, accompanied by the rapid advances in renewable energy (RE) technology, is expected to make RE economically viable. It is assumed that, over time, a major portion of desalination using conventional energy will be replaced by RE. Notwithstanding, due to the high initial cost, this volume considered CSP-powered desalination as the last supply option to eliminate unmet water demand. Thus, installed desalination capacity powered by RE is assumed to be sufficient only for domestic water supply in 2030, but to expand to meet additional domestic and industrial water supply needs by 2050.
- *Reduce irrigated areas.*<sup>7</sup> Unit cost: US\$0.10 per m<sup>3</sup>. The value of irrigation water normally ranges from US\$0.05 per m<sup>3</sup> to 0.15 per m<sup>3</sup> (Hellegers 2006). Forgone benefits can be considered unit costs. This value is, of course, strongly dependent on the prices of agricultural products,

which in turn are strongly affected by interventions by governments and trading blocs. It should be noted that reducing irrigated area is not an easy option to implement politically given the sensitivities surrounding food security and job security for unskilled labor that such decisions could invoke.

- *Reduce domestic and industrial demand.* Unit cost, including distribution costs: US\$2.00 per m<sup>3</sup>. Because drinking water is a necessity, its value can be expected to be very high. The other uses of water within households that make life more comfortable and within industry can be expected to have lower values (Young 2005). For instance, the forgone benefits of moving toward less water-intensive industries can be considered as unit costs of reduced industrial demand. Many MENA countries provide water supply and sanitation services to consumers at a highly subsidized price, thus inducing excessive use in areas where water supply is assured. Nevertheless, governments face an uphill battle to institute prudent demand management options such as tariff increases in municipal water consumption, making this option more difficult to implement.

## Alleviating the Demand Gap

Application at the country level of each of the nine adaptation options for the average climate scenario indicates that improved agricultural practice and desalination are the preferred technical options. They significantly increase annual water supplies (table 3.1). Unmet demand can be reduced by 55 km<sup>3</sup> through improved agricultural practice (option 1). Desalination could increase supplies and thus reduce the demand gap by 63 km<sup>3</sup> using option 6; and reduce it by an additional 53 km<sup>3</sup> using option 7 (a total of 116 km<sup>3</sup>). Conversely, increasing reservoir capacity is not a very effective adaptation option for the region because reduced precipitation would make additional storage capacity redundant in many countries. Consequently, expanding reservoir capacity would add only approximately 18 km<sup>3</sup> of additional water (4 km<sup>3</sup> through small-scale reservoirs and another 14 km<sup>3</sup> through large-scale reservoirs).

An important finding is that, without desalination, by 2050 the demand gap, although reduced, would approximate 142 km<sup>3</sup>. All demand reduction measures combined would reduce the demand gap by 258 km<sup>3</sup> by 2050. Without desalination, the gap would decline to 142 km<sup>3</sup> (258–116). Given that 199 km<sup>3</sup> are required to close the demand gap, desalination in the amount of 57 km<sup>3</sup> (199 km<sup>3</sup> – 142 km<sup>3</sup>) would be needed. However, this volume assumed that selection of tactical option 9 (which could pro-

**TABLE 3.1****Effect of Tactical Options under Average Climate Scenario to Reduce MENA Water Demand Gap by 2040–50 ( $km^3$  per year)**

Adaptation options	Demand				Supply			Demand gap			
	Total	Irrigation	Urban	Industry	Total	Surface water	Ground-water	Total	Irrigation	Urban	Industry
Current situation (2000–09)											
Reference scenario	393	265	88	41	192	151	41	199	136	43	20
Improve agricultural practice	-55	-55	—	—	—	—	—	-55	-47	-6	-2
Increase reuse of domestic and industrial water	—	—	—	—	12	10	2	-11	-6	-3	-2
Increase reuse of water in irrigated agriculture	—	—	—	—	8	7	1	-8	-6	-1	-1
Expand reservoir capacity (small scale)	—	—	—	—	4	4	—	-4	-3	-1	—
Expand reservoir capacity (large scale)	—	—	—	—	14	13	1	-11	-8	-2	-1
Desalination using fossil fuels	—	—	—	—	63	63	—	-63	—	-43	-20
Desalination using CSP	—	—	—	—	53	53	—	-53	—	-43	-10
Reduce irrigated area	-26	-26	—	—	—	—	—	-26	-23	-3	-1
Reduce domestic and industrial demand	-26	—	-18	-8	2	—	2	-25	-8	-12	-5
Total demand reduction/supply augmentation	-107	-81	-18	-8	155	150	5	-258	-101	-114	-42

Source: Adapted from FutureWater 2011.

Note: Summations do not add up due to rounding; — = not available.

vide 25  $km^3$ ) probably would be politically infeasible; thus desalination also would be required as a substitute. This substitution would increase the total desalination required to approximately 72  $km^3$ . Similarly, reduction of irrigated area is another politically sensitive issue, and governments may choose to invest in adding new water (through desalination) than reducing irrigated area. This too will increase the amount of desalinated water in MENA.” For these reasons, in addition to combinations of other tactical options, desalination is an essential adaptation option for MENA.

The extent that increased desalination capacity is required to close the gap varies by country (figure 3.2). According to the analysis in figure 3.2, Algeria, the Islamic Republic of Iran, and Tunisia do not appear to face significant water demand gaps, even without desalination. The assumption is that these three countries will maximize the use of existing water

FIGURE 3.2

### Desalination Will Play a Significant Role in Closing the Water Demand Gap in Most MENA Countries by 2040–50

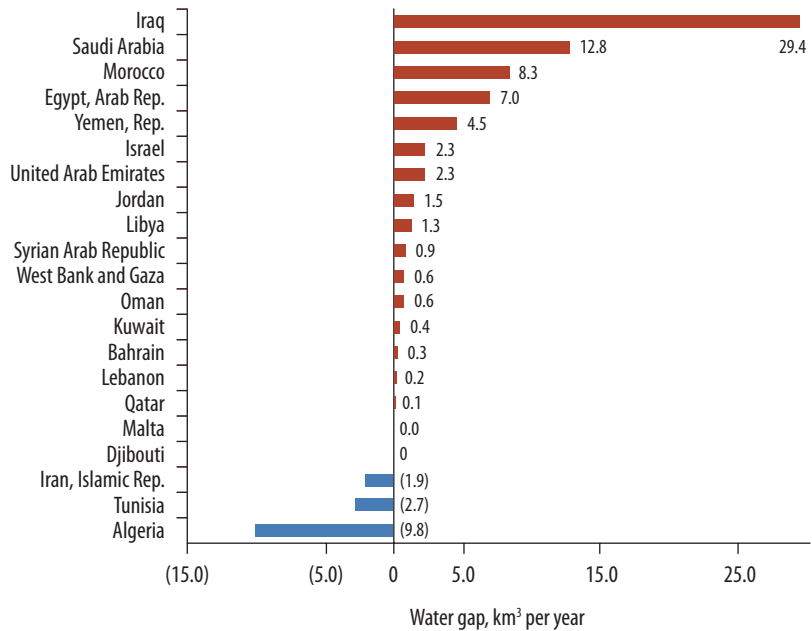

Source: Adapted from FutureWater 2011.

Note: The blue bars indicate there is not a water gap, whereas the red bars indicate the extent of the water gap.

supplies by adopting improved water use in the irrigation sector, building additional storage reservoirs as applicable, and perhaps implementing interbasin water transfer.

However, it is important to note that water balance analysis at the country level may conceal intracountry unevenness of water availability and water demand. As a result, even if the water balance shows excess at a national level, significant intracountry variability could necessitate desalination as the most likely option to close the unmet gap. Examples include some cities in Algeria in the middle and south, where fresh surface water and groundwater are unavailable. Thus, the country-level analysis of the water gap will remain indicative of needs until more detailed internal country assessments are completed.

Similar patterns of differing magnitude were found for the “dry” and “wet” climate projections. For all three projections, increasing agricultural practice (option 1) is still a very effective adaptation and on par with desalination.

Due to varying physical, cost, institutional, and sociopolitical factors at the country level, an option that works in one country may not work in

**FIGURE 3.3**

**Ranking and Magnitude of Tactical Options to Fill the Water Gap by 2050 Vary Considerably by Country**

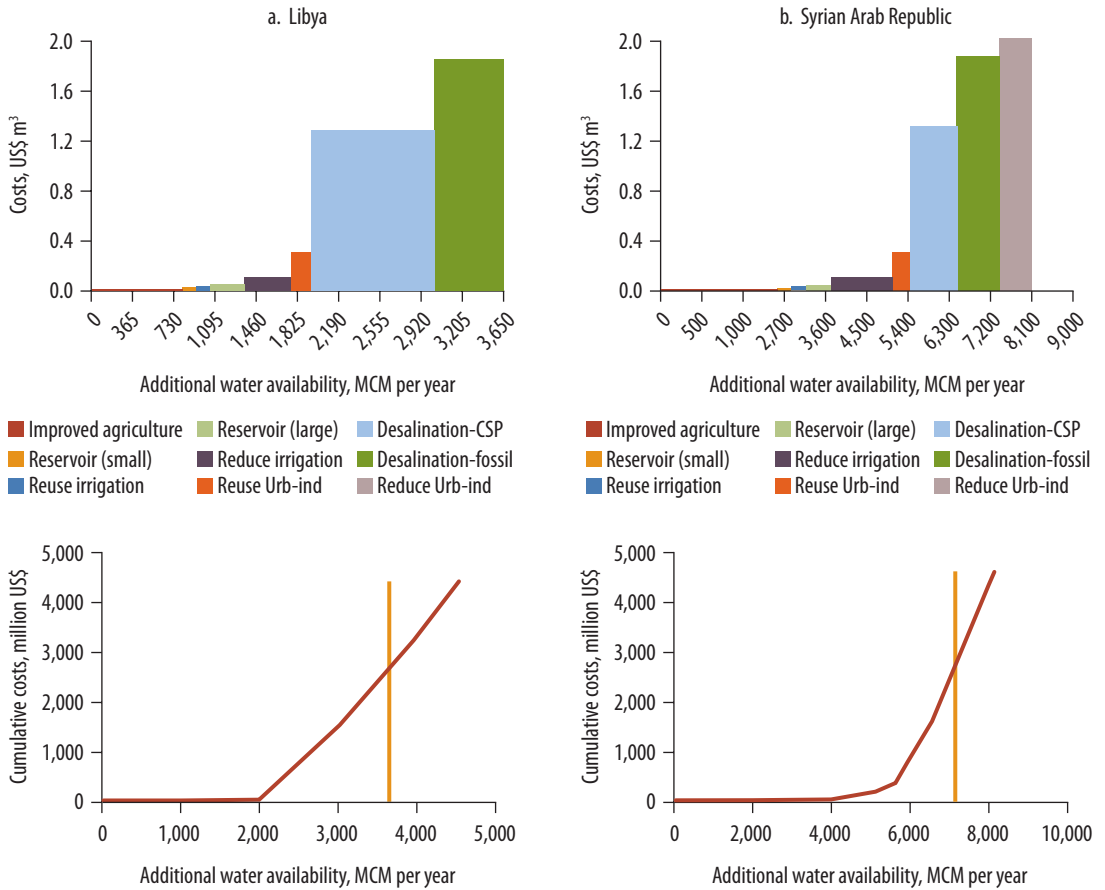

Source: FutureWater 2011.

Note: The vertical line in the lower figures of panels a and b indicates the water demand gap that can be filled with desalination.

another. This fact is particularly true in the agricultural sector, in which a deficit would remain even if all adaptation options were applied. One response among some of the region's richer countries has been for farmers to install small-scale reverse osmosis (RO) to desalinate brackish groundwater, as in parts of the United Arab Emirates; or to utilize recycled wastewater, as in Kuwait and Tunisia. Unless subsidized, these high water costs are viable only for high-value export crops. However, in many countries, these options are not practical because either they are not affordable or high-value agriculture is not practiced. Consequently, the ranking and magnitude of the selected tactical options differ considerably from country to country, as the comparison of Libya and Syrian Arab Republic illustrates (figure 3.3).

Libya will have to rely more on desalination than Syria because demand and supply management options for renewable water are able to fill approximately only half of Libya's demand gap (figure 3.3). In contrast, if it efficiently manages its renewable water resources, Syria would need desalination to fill approximately only 20 percent of its demand gap. Nonetheless, the cumulative cost of adaptation (shown in the lower figure) in 2050 are similar for both countries: approximately US\$1.7 billion for Libya and US\$1.9 billion for Syria.

### **Phasing of Tactical Options Strongly Influenced by Sunk Investment**

While most of the options for demand and supply management can be initiated quickly, such is not the case for desalination. The economic life of existing desalination capacity and new desalination capacity installed over the next 5 to 10 years will determine when replacement of installed desalination plants will be required. The Global Water Intelligence (GWI) desalination outlook shows that MENA's desalination capacity will double from 10.2 km<sup>3</sup> in 2010 to 22.7 km<sup>3</sup> by 2016 (GWI 2010). By that year, Saudi Arabia and the United Arab Emirates alone will make up over 50 percent of the total desalination capacity installed in the entire region. Given that planned additions of conventional desalination capacity until 2015 will proceed regardless, the baseline for future planning of desalination was taken as 2015.<sup>8</sup>

Decommissioning all existing and currently planned desalination plants will be completed by approximately 2045 (figure 3.4). The curves in figure 3.4 all show a pattern that is similar throughout MENA. Full decommissioning will occur in Syria by 2027 and in Malta by 2035. In all other countries, it will occur between 2041 and 43. More important, among the remaining countries, three will lose half of their existing desalination capacity by 2036, and the last 15 will lose half by 2039. Thus, to ensure adoption of RE desalination to replace existing capacity, CSP energy to power desalination must mature and become fully price competitive by approximately 2030.

Multiplying these curves by the annual production expected for 2015 indicates the volume of desalinated water production from conventional energy sources from 2000 to 50. For RO plants, the electricity mix to power them may be changed after 2015. The mix could be altered either to meet the electricity growth projected for MENA or to produce the power needed for RO by specifically installing equivalent additional CSP plants. In addition, new CSP-powered desalination capacities could be installed to meet growing demand.

FIGURE 3.4

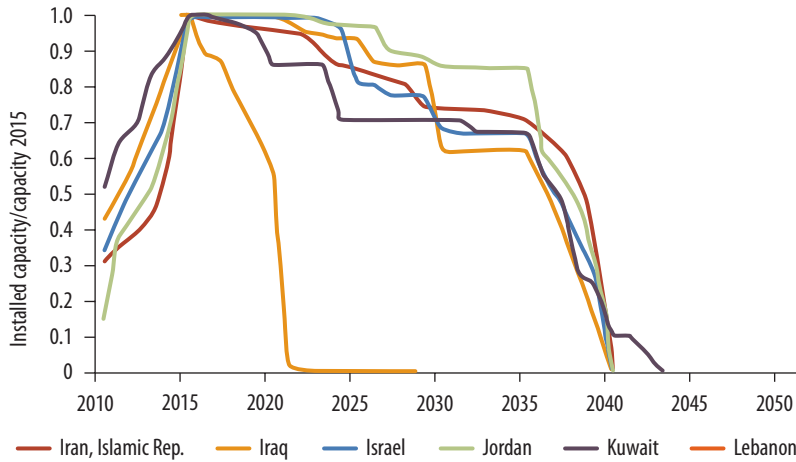
**Typical Desalination Plant Life Curves, 2010–50**

Source: Fichtner and DLR 2011 based on GWI/DesalData

Note: Existing and planned desalination capacity operational in 2015 is represented by 1.0. Decommissioning after 2015 reduces operational capacity. Gaps between curves and 1.0 represent need for new replacement capacity.

Replacing thermal desalination plants could be achieved either by installing combined solar power and desalination plants (using MED for desalination coupled to a solar-powered steam cycle); or by replacing thermal desalination units with RO powered by electricity generated from solar power.

**Transition from Conventional to CSP Desalination**

At present, due to their high cost, CSP desalination plants normally would be among the last options to be considered. They would be contemplated only after full use had been made of potential surface and groundwater extractions, wastewater reuse, and existing conventional desalination plants. Following this scenario, the annual expansion of CSP desalination capacity in each country would follow the curve shown in figure 3.5. Expansion would start with 100 million cubic meters (MCM) in 2015 (equivalent to three plants, each with a unit capacity of 33.5 MCM per year) and reach a maximum annual addition of 1,500 MCM after 2030. Growth is expected to be exponential from 2015 to 2020, linear after 2020, and constant after 2030.

Some countries, including Lebanon, Malta, and West Bank and Gaza, do not have enough CSP potential to power all the required desalination plants because of availability of suitable land for CSP facility. In such coun-

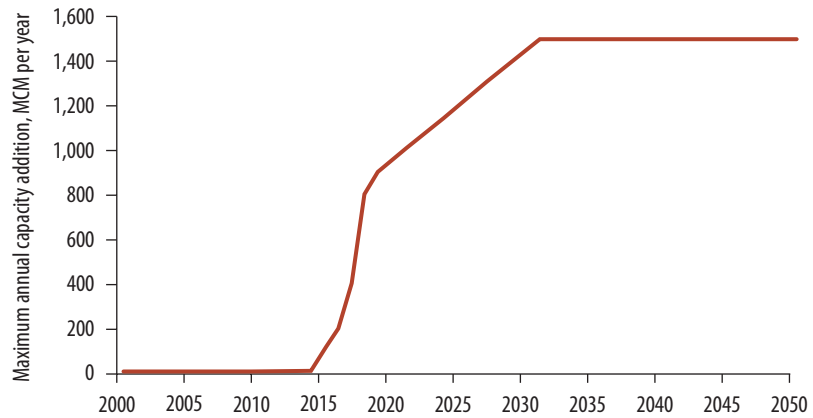
**FIGURE 3.5****Maximum Annual Capacity Additions for CSP Desalination Plants in MENA**

Source: Fichtner and DLR 2011 based on GWI/DesalData.

tries, a mix of existing sources could be used to power the required desalination plants. Alternatively, CSP energy imports could be considered.

### Phasing the Tactical Options

Taking into account the phasing of new desalination investment, the growth of cost-optimized water supply options over the period to 2050 is compared in figure 3.6. The upper red line is the total regional water demand if none of the tactical options is adopted and if water use follows the business as usual (BaU) scenario. When the tactical options are adopted, total regional water demand can be met from a smaller supply base due to efficiency gains (gray area in figure 3.6). While unsustainable groundwater extractions (yellow) will be almost eliminated by 2030, they will recur subsequently during periods of drought when surface water availability is reduced.

Figure 3.6 clearly shows that, during the planning period, surface water remains the single largest water supply—but this statement effectively applies to only Egypt, Iraq, and Syria. Most other countries will have to rely on desalination, wastewater reuse, and careful stewardship of groundwater to meet future water demand.

### Costs of Adaptation Measures

The additional projected annual water needs are 199 km<sup>3</sup> by 2040–50. If the least expensive tactical options are selected, the total annual cost to



FIGURE 3.6

### Cost-Optimized Pattern of Future Water Supply for MENA under the “Average” Climate Change Scenario, 2000–50

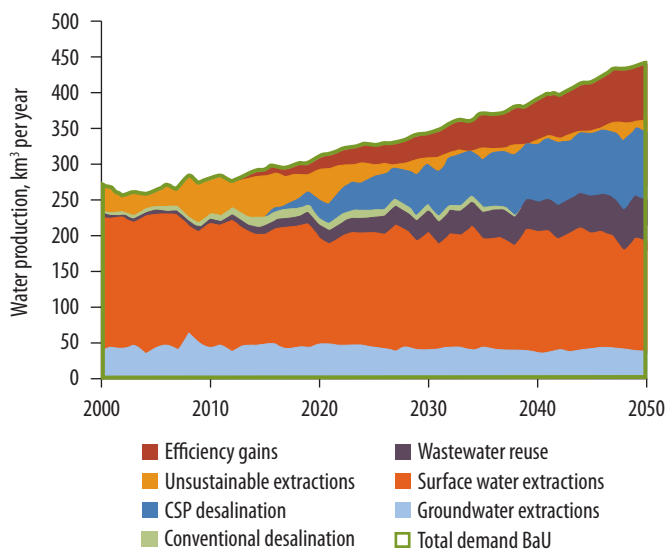

Source: Fichtner and DLR 2011.

bridge the unmet water gap will be approximately US\$104 billion (table 3.2). The annual cost will increase to US\$212 billion for the dry climate scenario because the water gap will increase to 283 km<sup>3</sup>. If the wet scenario occurs, the annual cost of meeting the demand gap of 85 km<sup>3</sup> will be reduced to US\$27 billion.

Average annual adaptation costs will increase from the wet to dry climate scenario because more expensive adaptation strategies are utilized at the margin. Thus, the average adaptation unit cost for each incremental cubic meter of water by 2040–50 for the wet, average, and dry climate scenarios, respectively, will be US\$0.32, US\$0.52, and US\$0.75. The bigger the gap, the more the region will have to rely on expensive adaptations such as desalination.

### Individual Countries

There is no single water crisis in MENA: the crisis has many faces. Because the assessment presented in the previous sections is general, it should be interpreted with great care. Different countries face very different choices and costs regarding how to close their water gaps.

The average adaptation costs per incremental cubic meter of water are US\$0.52 in the region, but these costs vary substantially by country (table 3.2). Adaptation costs come to US\$0.02 in Algeria, whose improved agricultural practice can almost bridge the gap. Costs soar to the opposite

TABLE 3.2

**Adaptation Costs by Country Ranked by Costs per Capita**

Country	Shortage (MCM)	Costs				
		US\$ million	US\$ per m <sup>3</sup>	US\$ per capita	% of GDP 2020–30	% of GDP 2040–50
United Arab Emirate	3,189	3,116	0.98	716	2.36	0.79
Iraq	54,860	39,574	0.72	647	7.56	2.52
Saudi Arabia	20,208	15,849	0.78	271	1.41	0.47
Israel	3,418	2,788	0.82	265	0.49	0.16
Bahrain	383	335	0.87	248	0.78	0.26
Morocco	15,414	13,104	0.85	236	4.72	1.57
Libya	3,650	1,860	0.51	170	0.56	0.19
Qatar	246	158	0.64	170	0.20	0.07
Jordan	2,088	1,746	0.84	164	4.04	1.35
West Bank-Gaza	925	769	0.83	151	n.a.	n.a.
Oman	1,143	846	0.74	116	0.75	0.25
Kuwait	801	600	0.75	112	0.30	0.10
Egypt, Arab Rep.	31,648	11,321	0.36	76	2.44	0.81
Lebanon	891	363	0.41	72	1.19	0.40
Yemen, Rep.	8,449	5,927	0.70	63	11.82	3.94
Malta	36	26	0.72	57	0.40	0.28
Syrian Arab Republic	7,111	1,926	0.27	54	1.45	0.49
Iran, Islamic Rep.	39,939	3,112	0.08	29	0.24	0.08
Algeria	3,947	83	0.02	1	0.01	0
Tunisia	837	17	0.02	1	0	0
MENA	199,183	103,520	0.52	148	1.61	0.54

Source: FutureWater 2011.

Note: n.a. = not applicable.

extreme of US\$0.98 in the United Arab Emirates, whose gap would be bridged primarily by desalination. Adaptation costs are below US\$0.36 in Algeria, Egypt, the Islamic Republic of Iran, Syria, and Tunisia. In these five countries, incremental demand can be met primarily through least-cost measures. On the other hand, countries that require significant new desalination capacity generally will have incremental water costs greater than US\$0.64. Such countries include Bahrain, Iraq, Israel, Jordan, Kuwait, Malta, Morocco, Oman, Qatar, Saudi Arabia, the United Arab Emirates, and West Bank and Gaza. The highest per capita adaptation costs occur in the United Arab Emirates, Iraq, and Saudi Arabia. Average per capita costs, respectively, are 716, 647, and 271 US\$.

More than 83 percent of the region's US\$104 billion burden to bridge the 199 km<sup>3</sup> water demand gap by 2040–50 must be paid by five countries: Iraq (38 percent), Saudi Arabia (15 percent), Morocco (13 percent), the Arab Republic of Egypt (11 percent), and the Republic of Yemen (6 percent). The Islamic Republic of Iran, Israel, and the United Arab Emirates combined are responsible for 9 percent. The remaining 13 countries are responsible for less than 10 percent of the total cost.

By 2040–50, for the average climate projection, the average annual per capita adaptation cost in the MENA Region will be approximately US\$148.

### Impact of Adaptation on Country Economies

The total current gross domestic product (GDP) of the 21 MENA countries is approximately US\$1.6 trillion. The total regional adaptation cost of US\$104 billion in 2040–50 will take up approximately 6 percent of current regional GDP. Future GDP will be higher, however, so adaptation costs will be less onerous. Based on CIESIN's GDP projections (2002) of approximately US\$6.5 trillion by 2030–40, and US\$19 trillion by 2040–50,<sup>9</sup> the cost of closing MENA's water gap under the average climate change scenario will vary from 0.5 to 1.6 percent of GDP.

However, substantial differences can be observed among individual countries arising from the severity of their water shortages and projected GDP per country (table 3.2). In the future, countries such as Egypt, Iraq, Jordan, Morocco, and the Republic of Yemen must be prepared to spend a substantial portion of their GDP on overcoming their large water shortfalls. In the short- to medium-term, the Republic of Yemen has the highest coping cost because its groundwater resources—the primary source for potable water supplies—are near exhaustion.

### Notes

1. Reducing irrigated areas is politically one of the most difficult options to implement because it evokes sensitive policy issues such as food security and job security for unskilled labor.
2. One Feddan equals 4,200 m<sup>2</sup>; one LE equals US\$0.17.
3. If the quality of return flow is much poorer and needs additional treatment to be reused in irrigation, the cost of reuse will be much higher.
4. Although the cost of natural gas and oil could be determined based on the prevailing international price, electricity cost is harder to determine as each country has various ways of generating electricity (hydro, wind, PV, biomass, and so on) that could have different per-unit costs. For simplicity, this volume assumes that only natural gas (NG) and oil (heavy fuel oil, or HFO) are used to generate electricity for desalination. Therefore, the electricity equivalents of a unit of NG and HFO are used to determine their opportunity costs at international prices.
5. The estimate considers a CAPEX reduction by 20 percent, OPEX decrease by 10 percent, and additional environmental cost impacts by 5 percent. Regarding energy costs, a price reduction from US\$0.22 per kWh (2010) to 0.08 US\$ per kWh (2050) is considered for the electricity generated from CSP plants due to efficiency gains in CSP technology. This volume also assumes that water production costs from conventional desalination plants will increase from US\$1.3 per m<sup>3</sup> (2010) to US\$2.5 per m<sup>3</sup> (2050), taking into account that conventional

- electricity prices will increase from US\$0.11 to 0.18 per kWh due to decreasing availability of fossil fuel resources. The prices are in today's US\$.
6. Since RE is not cost competitive compared to fossil energy, for the short and medium term (until 2030), this volume assumes that desalination plants will be run on hybrid energy based on a 46–54 percent solar share (appendix C).
  7. This is the same as adopting a virtual water policy.
  8. Conventional desalination capacity existing at present in each country was derived from the Desaldata database (GWI 2010), and the outlook to 2016 (GWI 2010). It is assumed that plants operate 8,000 h per year at 54 percent of capacity. This assumption projects an economic life of 20 years for RO, 25 years for MED, and 35 years for multi-stage flash distillation (MSF) plants.
  9. As stated earlier, all costs are converted to US\$2010 prices.

## References

- 2030 Water Resources Group. 2009. "Charting Our Water Future: Economic Frameworks to Inform Decision-Making," [http://www.2030waterresourcesgroup.com/water\\_full/Charting\\_Our\\_Water\\_Future\\_Final.pdf](http://www.2030waterresourcesgroup.com/water_full/Charting_Our_Water_Future_Final.pdf).
- CIESIN (Center for International Earth Science Information Network). 2002. *Country-level GDP and Downscaled Projections based on the A1, A2, B1, and B2 Marker Scenarios, 1990-2100* [digital version]. Palisades, NY: CIESIN, Columbia University. <http://www.ciesin.columbia.edu/datasets/downscaled>.
- Di Prima, S. 2007. Sand Dams in Kitui district, Kenya. Internal Working Document. VU-CIS Amsterdam, 15 pp.
- Fichtner and DLR. 2011. *MENA Regional Water Outlook, Part II, Desalination Using Renewable Energy, Task 1–Desalination Potential; Task 2–Energy Requirements; Task 3–Concentrate Management*. Final Report, commissioned by the World Bank, Fichtner and DLR. [www.worldbank.org/mna/watergap](http://www.worldbank.org/mna/watergap).
- FutureWater. 2011. *Middle-East Northern Africa Water Outlook. Final Report*, commissioned by the World Bank, W. Immerzeel, P. Droogers, W. Terink, J. Hoogeveen, P. Hellegers, and M. Bierkens (auth.). Future Water Report 98, Wageningen, the Netherlands. [www.worldbank.org/mna/watergap](http://www.worldbank.org/mna/watergap).
- GWl (Global Water Intelligence). 2010. *GWl Desalination Market Forecast March 2010: DesalForecastMarch2010.xls*. Oxford. <http://www.globalwaterintel.com/>.
- Hellegers, P. J. G. J. 2006. "The Role of Economics in Irrigation Water Management." *Irrigation and Drainage* 55: 157–63.
- Trieb, F., and H. Müller-Steinhagen. 2008. "Concentrating Solar Power for Seawater Desalination in the Middle East and North Africa." *Desalination* 220 (1–3): 165–83.
- Trieb, F., H. Müller-Steinhagen, and J. Kern. 2011. "Financing Concentrating Solar Power in the Middle East and North Africa: Subsidy or Investment?" *Energy Policy* 39: 307–17.

WCD (World Commission on Dams). 2000. *Dams and Development: A New Framework for Decision-Making*. The Report of the World Commission on Dams. London: Eastern Publication. [http://www.internationalrivers.org/files/world\\_commission\\_on\\_dams\\_final\\_report.pdf](http://www.internationalrivers.org/files/world_commission_on_dams_final_report.pdf).

Young, R. A. 2005. *Determining the Economic Value of Water: Concepts and Methods*. Washington, DC: Resources for the Future.



## Desalination in MENA and Its Energy Implications

All MENA countries<sup>1</sup> have access to seawater as a source of water for desalination. Additionally, as a result of historical regional trade links and use of maritime resources, most MENA countries have their major population centers, and thus water demand, located close to the sea. The notable exceptions are the Islamic Republic of Iran, Jordan, the Syrian Arab Republic, the Republic of Yemen, and, to a lesser extent, Saudi Arabia, all of which have inland capitals. In addition, most MENA countries are believed to have extensive, although little explored and mostly unutilized, brackish groundwater resources.

Desalination enables coastal communities to utilize a practically inexhaustible supply of saline water. In the past, the difficulty and expense of removing various dissolved salts from water made saline waters an impractical source of potable water. However, starting in the 1950s, desalination became economically viable for ordinary use. Subsequently, many MENA countries developed facilities for desalination in response to shortages of naturally available freshwater supplies. By 2007 approximately 54 percent of the world's desalination potential was installed in the MENA Region (figure 4.1). Worldwide production of desalinated water then was approximately 44 km<sup>3</sup> a year: 58 percent from seawater, 22 percent from brackish water, and 5 percent from wastewater.

By 2016 MENA's share of global demand is projected to account for approximately 70 percent of the increased global capacity for desalination (GWI 2010). Of the 15 countries with the largest conventional desalination installations, 9 are in the MENA Region.

Desalination has proved to be a technically feasible supply solution to MENA's water gap and will continue to be. Within the Gulf Cooperation Council (GCC) countries, dependence is high (figure 4.2).<sup>2</sup> However, dependence dwindles among the Maghreb countries in which even the biggest users, Algeria and Libya, rely on desalination for less than 5 percent of their water supplies.

**FIGURE 4.1**

**Distribution of Worldwide Desalination Capacity, 2007**

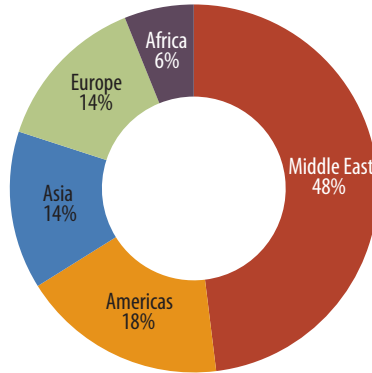

Source: Lattemann 2010.

**FIGURE 4.2**

**Share of National Water Demand in MENA Met by Desalination, 2010**

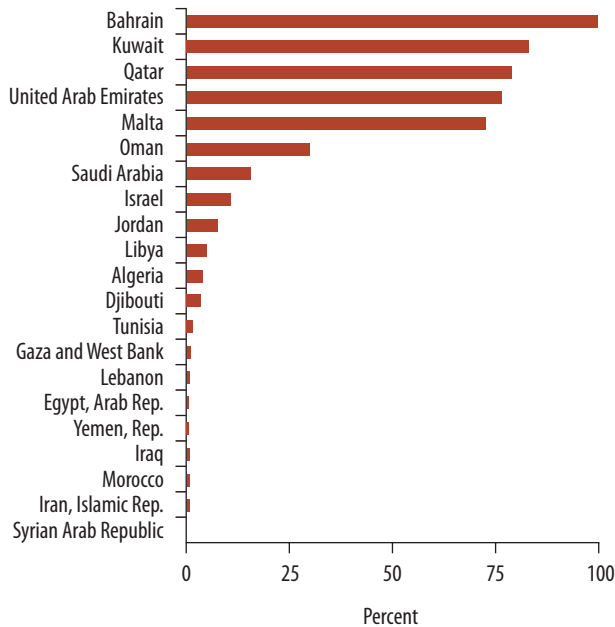

Source: Fichtner and DLR 2011.

The three biggest challenges will be finding ways to reduce the cost of energy-intensive desalinated water, to minimize its reliance on fossil fuels, and to ensure that it becomes an environmentally acceptable solution. This chapter discusses the potential for desalination and renewable energy (RE) in MENA, and associated challenges in technology, sustain-



able energy supply, cost, and the environmental implications of desalination.

Currently, cheaper fossil fuel will make RE uncompetitive unless governments are prepared to support their adoption of RE based on its potential contribution to energy security, the reduction of the carbon footprint of electricity production, and “green” energy trading opportunities. However, in the longer term, fossil fuels are highly unlikely to continue to be cheaply available to the MENA Region. Oil and gas will become more expensive principally as demand from South Asia and China come to dominate world markets. Moreover, if the international agreements to minimize greenhouse gas (GHG) emissions take effect and countries are required to pay premium prices to support sequestration of GHGs, use of fossil fuels could become even more expensive. In this context, RE may become highly competitive with fossil fuels.

## Growth of Desalination in MENA and Associated Challenges

High oil prices in the early 1970s sparked the growth of desalination in the Middle East. The inflow of funds enabled the Gulf states to invest in the development of their infrastructure on a grand scale. Investments in power and water were included. At the time, the only commercially viable large-scale technology for desalination was the multistage flash distillation (MSF).<sup>3</sup> Subsequently, multiple effect distillation (MED) and reverse osmosis (RO) technologies have become equally viable for large-scale desalination.

MED and MSF plants typically are set up to obtain energy from adjacent thermal power stations run by fossil fuels—mainly oil but, more recently, oil and gas. A plant’s energy production may be dedicated entirely to the production of potable water as a standalone facility. However, more commonly, the energy production is used to generate both electricity and water. This physical set-up, known as *cogeneration*, allows access to cooling water, which can be both a water source for desalination and thermal and electrical energy; and a dump for the treated brine concentrate produced by desalination.

As both the populations and the water demand of the Gulf countries burgeoned, MSF remained their preferred desalination technology, due primarily to its proven long-term record for large-scale water production. In addition, combining a power plant with a thermal desalination plant in a dual-purpose configuration is advantageous for both utilities. Moreover, only the GCC countries have the power-water sector set up with the same regulators and utilities for power and water. MSF also has demonstrated a long economic life—approximately 25 years—much greater

than anticipated at construction (15 years); and, when properly operated and maintained, its performance degradation is very low. MSF plant operations and maintenance (O&M) are very similar to the power plants to which they are coupled, so that finding personnel for O&M does not represent a major problem.

In recent years, MED technology is catching up and is likely to become more widespread due to its lower energy demand and significant potential for further development. Given the high salinity and high temperature of the Gulf water, thermal desalination technologies usually are better suited. Elsewhere, however, the high dependence on fossil fuels in cogeneration was seen as disadvantageous.

RO is based on moving pressurized brine across membranes that allow fresh water to pass through and retain salts, thus increasing the brine concentration on one side and producing fresh water on the other. The earlier distillation processes use constant amounts of energy per unit of water processed. In contrast, energy use per unit of water in RO plants increases as the input water quality deteriorates. In addition, RO plants require only electrical energy; thus, they neither must be located near the sea nor directly linked to a cogeneration power station. Initially, RO membranes were expensive; pretreatment was not well understood; and energy consumption was high. Since then, membrane prices have fallen; their performance has improved; pretreatment is better understood; and energy consumption has dropped dramatically. Hybrid configurations of different desalination technologies also are being used to optimize the benefits from each technology. For example, the Fujairah power and desalination plant in the United Arab Emirates is a hybrid of MSF and RO desalination technologies; it produces approximately 455,000 m<sup>3</sup> of desalinated water per day.

Commercialization of RO for seawater desalination plants in MENA started in 1980 with the installation of the first commercial plant in Jeddah, Saudi Arabia (*Economist* 2008). At that time, production of each cubic meter (m<sup>3</sup>) of fresh water used 8 kilowatt hours (kWh) of electricity because energy use was only 75 percent efficient. The most recent RO plant installed in Perth, Australia is 96 percent energy efficient and uses 53 percent less energy. Although the Gulf states remain the most important market for desalination plants, designing RO plants for operation in the Gulf must overcome the problems caused by high salinity and seawater temperatures. (These two conditions make little difference to distillation plants.) As a consequence, adoption of RO has been slow in the Gulf states (figure 4.3a). Outside the Gulf, however, membrane desalination processes (primarily RO) have accounted for most of the growth in desalination capacity since 2000 (figure 4.3b).

FIGURE 4.3

## Growth of On-Line Desalination Capacity in MENA, 1950–2010 (MCM)

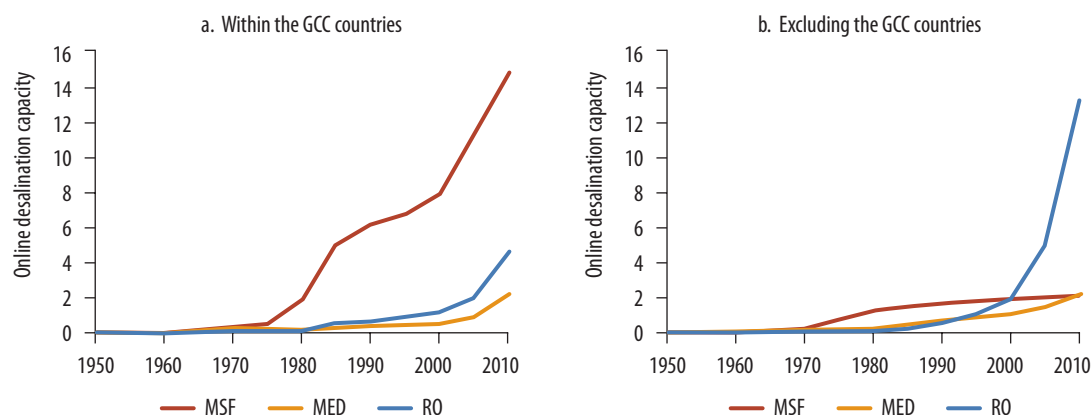

Source: GWI/DesalData 2010.

Note: For more updated figures and analysis, contact GWI/DesalData: [st@globalwaterintel.com](mailto:st@globalwaterintel.com).

Distillation requires twice as much saline feed water as RO to produce the same volume of fresh water (table 4.1). However, unlike using thermal desalination, the efficiency of fresh water production through RO increases as the feed water becomes less salty.

MSF and MED desalination also pose more challenging brine disposal because they produce twice as much brine as RO when treating seawater, and up to four times as much when using brackish source waters. However, brine produced by RO plants usually is more concentrated than that produced by MSF or MED plants and requires more treatment for safe disposal. Considering the source waters and brine effluent produced, the environmental requirements of MSF and MED are considerable and are best addressed by locating them near the sea. RO site requirements are less onerous. Indeed, RO functions more efficiently inland using brackish source water—provided that disposal of waste brine can be managed acceptably. Table 4.2 summarizes the major commercial desalination technologies available today. Additional technologies are under research

TABLE 4.1

## Efficiency of Converting Saline to Fresh Water and Brine Effluents

Environmental requirement or impact	Distillation		RO	
	MSF	MED	Seawater	Brackish water
Volume of feed water per m <sup>3</sup> of fresh water	4.0	3.0	2.0–2.5	1.3–1.4
Volume of brine effluent per m <sup>3</sup> of fresh water	3.0	2.0	1.0–1.5	0.3–0.4

Source: World Bank 2004.

TABLE 4.2

## Summary Characteristics of Various Commercial Desalination Technologies

Desalination technology	MSF	MED (Plain)	MED-TVC	RO	UF/MF/NF	Electro-dialysis reversal (EDR)
Energy source/type	Thermal	Thermal	Thermal	Electricity	Electricity	Electricity
Typical energy consumption (kWh/m <sup>3</sup> ) electricity	3–5	1.5–2.5	<1.0	3–5	3–5	3–5
(MJ/m <sup>3</sup> ) heat	233–258	233–258	233–258	No heat energy needed	No heat	No heat
Capacity range	Current modular capacity up to 90,000 m <sup>3</sup> /day	Current modular capacity up to 38,000 m <sup>3</sup> /day	Current modular capacity up to 68,000 m <sup>3</sup> /day	Current modular capacity up to 10,000 m <sup>3</sup> /day	Current modular capacity up to 10,000 m <sup>3</sup> /day	Current modular capacity up to 34,000 m <sup>3</sup> /day
Advantages	<p>Easy to manage and operate.</p> <p>Can treat very salty water up to 70,000 mg/L.</p>	<p>Can be operated between 0% and 100% capacity while MED unit is kept under vacuum and cold circulation; suitable to combine with RE sources that supply intermittent energy.</p> <p>Suitable to link with RE.</p>	<p>Helps reduce number of effects</p> <p>Adapts MED design to a broad range of pressures (1–40 bars).</p> <p>Very low electrical consumption compared to MSF and plain MED or RO.</p> <p>Operate at low temp (&lt;70°C) and low concentration (&lt;1.5) to avoid corrosion and scaling.</p>	<p>Easily adapts to local conditions.</p> <p>Plant size can be adjusted to meet short-term increases in demand and expanded incrementally as needed.</p> <p>Significant cost advantage in treating brackish groundwater.</p> <p>Can remove silica.</p> <p>Capital cost approximately 25% less than thermal options.</p>	<p>Usually used in combination with RO plants (for pretreatment).</p> <p>Reduces fouling on RO plants, hence reducing cost and saving energy as well as reducing chemical use in RO.</p> <p>NF in particular could be used as a “softening” step for RO, rejecting multivalent and mono-valent ions.</p>	<p>High recovery rate of up to 94%.</p> <p>Longer-life membranes (up to 15 years when operated properly).</p> <p>Can be combined with RO for higher water recovery of up to 98%.</p>
Disadvantages	<p>Cannot operate at below 60% capacity.</p> <p>Not suitable to combine with renewable energies that have intermittent energy supplies.</p> <p>High energy use (3–5 kWh/m<sup>3</sup> electricity and 233 MJ/m<sup>3</sup>–258 MJ/m<sup>3</sup> heat required).</p>	<p>Anti-scalents required to stop scale build-up on evaporating surfaces.</p>	<p>Cannot operate at below 60% capacity.</p> <p>Not suitable to combine with RE that has intermittent energy supply.</p>	<p>Requires comprehensive pretreatment to be used for high saline water.</p> <p>Membrane fouling</p> <p>Complex configuration and requires skilled personnel for O&amp;M.</p>	<p>Membrane fouling.</p> <p>Although much less than RO, still a complex configuration and requires skilled personnel for O&amp;M.</p>	<p>Capital intensive and costly compared to RO.</p>

Sources: Fichtner and DLR 2011; World Bank 2004.

Note: Although thermal energy is used for desalination in MSF, MED, and MED-TVC plants, they also require electrical energy to pump water and circulate chemicals. Abs = absolute; NF, MF, and UF = nano-, micro-, and ultrafiltration.

and development, including forward osmosis (FO), membrane bio-reactor (MBR), membrane distillation-variable salinity plant (VSP), and ion-exchange resin (IXR). While some of the immediately preceding technologies are at an early stage of development, others have been piloted and work is underway to commercialize them.

Desalination from the sea is vulnerable to oil spills, other marine pollutants, and algal blooms. For example, the United Arab Emirates' desalination operations at Fujairah and Khor Fakkan on the Gulf of Oman were disrupted from August 2008 through March 2009 by a series of "red tide" algal blooms. These events decreased production by up to 40 percent due to filter clogging, losing up to US\$100,000 a day. Desalination plants located on the coast also are vulnerable to terrorist or regional conflicts.

Water transfer systems also may increase the vulnerability of the water supply if water distribution networks are exposed to natural disasters, hazards, facility failures, or contaminations. Thus, to ensure secure supplies, sufficient storage capacity for desalinated water plus independent backup power to pump the water are required.

## Future Trends in Desalination

Forecasts of global desalination growth anticipate that RO will account for approximately 73 percent of all new capacity installed by 2016 (figure 4.4). During this period, nine MENA countries are predicted to be among

**FIGURE 4.4**

### Forecast of Annual Global Growth of Desalination by Technology, 2006–16

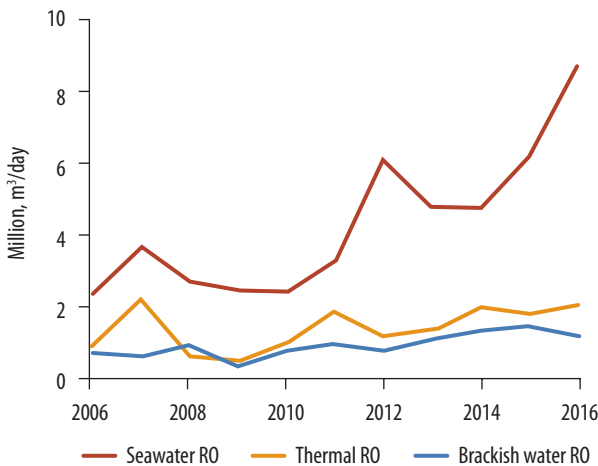

Source: GWI/DesalData 2010.

**FIGURE 4.5**

**MENA Prominent among Top 15 Desalination Markets, 2007–16**

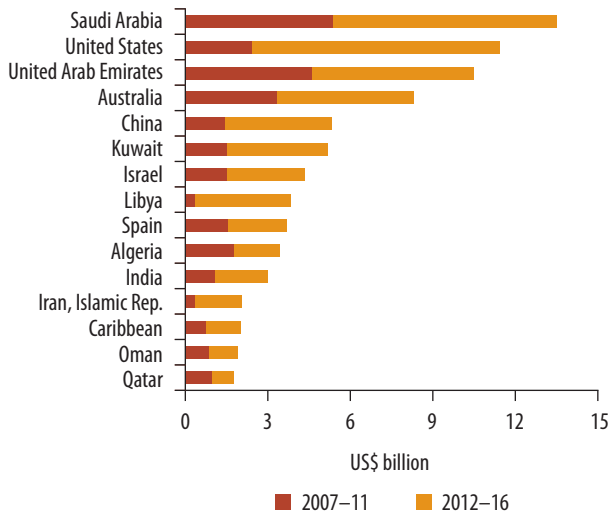

Source: GWI/DesalData 2010.

the top desalination markets globally (figure 4.5). Moreover, given the increasing water demand gap and deteriorating water quality worldwide, it is largely inevitable that new water sources through desalination and reuse should, and will, be part of the future water supply portfolio.

**Factors Affecting Technology Choice**

The single biggest factors affecting technology choice are the salinity and temperature of the source water (table 4.3). The salinity of seawater influences mainly efficiency and RO desalination performances. The MED and MSF have more stable behavior and are less influenced by salinity.

RO is the technology most adaptable to local circumstances. The plant size can be adjusted to meet short-term increases in demand and expanded incrementally as needed. RO also has a significant cost advantage in treat-

**TABLE 4.3**

**Seawater Characteristics Vary Widely in MENA**

Water source	Salinity range (mg/L)	Temperature (°C)
Mediterranean and Atlantic	38,000–41,000	15–30
Red Sea and Indian Ocean	41,000–43,000	20–35
Gulf water	45,000–47,000	20–35

Source: Modified from Fichtner and DLR 2011.

ing brackish groundwater because distillation needs the same amount of energy regardless of salinity; whereas, for RO, the energy needed drops significantly at lower salinity. In Jordan, for example, annualized costs of RO were US\$1.7 per m<sup>3</sup> for seawater but only US\$0.65 for brackish groundwater. In comparison, MSF was US\$2.7 per m<sup>3</sup> and MED US\$1.2 per m<sup>3</sup> (Mohsen and Al-Jayyousi 1999). Accordingly, Mohsen and Al-Jayyousi recommended that, due to its very high water quality, operational flexibility, and medium capital cost, RO is well suited to desalinate brackish groundwater, which occurs in many areas including Azraq, the Jordan Valley, and Wadi Araba, for domestic and industrial users.

Water security is also another factor that dictates the choice of desalination technology. For example, thermal desalination technologies such as NSF and MED operate under a wider range of feed-water quality, including the presence of impurities (for example, algae), compared to RO technologies. Similarly, as discussed earlier, the need for safe disposal of brine and other chemicals also affect the choice of desalination technologies.

### **Desalination Costs**

Overall, desalination is a costly water supply option. However, for some countries and communities, desalination may be the only viable option available.

#### ***Capital investment costs***

These costs include those related to intake and outfall systems, water storage and pumping, site preparation and civil works, mechanical equipment, and electrical works. For SWRO plants, based on quality of feed-water, significant capital costs are allocated to pretreatment and wastewater (brine) treatment. Table 4.4 summarizes the investment cost to produce a cubic meter of water based on typical medium-sized installations.

Capital investment costs are very location specific and vary by the type of construction contract and size of the plant. Contract packaging, including the financing modality for the project, is likely to affect plant costs due to various commercial conditions, especially the limits of liability and foreign exchange risks. In addition, cost data will be affected by seawater quality, site topography, and minimum environmental impact mitigation requirements. These conditions are particularly relevant in Australia and the United States, due chiefly to regulatory issues and environmental requirements. Costs also are highly sensitive to commodity price fluctuations and competition for other resources such as capable fabricators or experienced personnel. For example, from 2006 to 2008, prices escalated significantly compared to 1998–2005 due to the rapidly increasing demand for new desalination capacity and raw materials (such

**TABLE 4.4****Typical Capital Investment Costs of Desalinated Seawater**  
(US\$ per m<sup>3</sup> per day)

	MSF	MED-TVC	SWRO
Capital investment cost, 1998–2005	900–1,750	900–1,450	650–900
Capital investment cost, 2006–08	1,700–2,900	1,700–2,700	1,300–2,500
Current study <sup>a</sup>	n.a.	1,800	1,748–2,425

Source: Fichtner and DLR 2011.

Note: Data from previous contracts (1998–2008) are based on actual contracted cost irrespective of plant size, site conditions, and type of contract (engineering, procurement and construction or EPC; build own operate transport, or BOOT). n.a. = not applicable.

a. The cost estimate is based on a medium-sized desalination plant with capacity of approximately 100,000 m<sup>3</sup> per day. Large cost variation under seawater reverse osmosis (SWRO) is due to different pretreatment levels (appendix C). In this volume, MSF was not considered for analysis as it normally requires more energy than MED.

as stainless steel alloys). In general, however, the aftermath of the 2008–09 financial crisis substantially lowered capital investment costs, indicating that the trend increasingly is a buyer's market. If construction risks also can be reduced for all three technologies, innovative financing packages could reduce overall investment costs.

Generally, capital investment costs can be expected to be quite similar for both conventional thermal desalination technologies: approximately US\$1,700 per m<sup>3</sup> per day installed capacity. In comparison, capital costs of RO plants are approximately 25 percent lower.

**Operational costs**

Transporting desalinated water from source to consumers also can be very expensive, particularly for highlands and continental interiors (box 4.1). Energy availability and sources (and associated energy costs), site conditions as well as stringency of environmental regulations also dictate the choice of desalination technologies. A 1999 literature review suggests that transport costs could increase delivered water costs by a few percent to as much as 100 percent (Zhou and Tol 2005). Specifically, it was found that a 100 m vertical lift is approximately as costly as a 100 km horizontal transport (US\$0.05 per m<sup>3</sup>–0.06 per m<sup>3</sup> at 2005 prices). Such cost impacts should be taken into consideration for appropriate site selection. Transport costs could be reduced by building desalination facilities close to demand centers and trading off reduced transport costs against diseconomies of scale.

These costs include those related to labor, energy, chemicals and insurance. For SWRO plants, the operational costs also include those related to membranes and additional costs of chemicals used for pretreatment and post-treatment. These costs vary substantially by specific



**BOX 4.1****Desalination is a Possible Option for Sana'a, Yemen, Rep., but Transport Costs Could Be Prohibitive**

Sana'a's population has grown quickly (by approximately 7% per year) during the last decade, making it the world's third fastest growing capital city. Sana'a is projected to quintuple from 1.6 million in 2000 to 8.4 million in 2050. A strong increase is foreseen in the annual per capita water withdrawals from 17 m<sup>3</sup> per capita in 2010 to 96 m<sup>3</sup> per capita in 2050. From 2000 to 2050, these two factors combined will increase domestic water demand in Sana'a city by 3,300%. Local groundwater resources are projected to be unable to meet this demand, and desalination is a potential solution. While Sana'a is at an elevation of 2,250 m, the total pumping lift is 3,934 m. The undulating horizontal distance is 139 km. In addition to the unit cost of desalination (US\$2.0–3 per m<sup>3</sup>) (table 4.6), the unit cost to transport water would be approximately US\$2 per m<sup>3</sup>, bringing the overall cost of desalinated water in Sana'a to US\$4–5 per m<sup>3</sup>.

Source: FutureWater 2011.

engineering configurations, economies of scale, and time-variant fuel costs (table 4.5). The relatively high costs for MSF are the result of its high energy use. Although absolute costs have changed over time, the ranking of costs by technology remains unchanged.

Operational costs account for about 40–60 percent of total cost of desalinated water. Based on location of the water demand center, operation costs could be higher. For example, for cities located far away and at higher elevations, such as Sana'a and Taiz in Yemen and Riyadh in Saudi Arabia, the operational costs could be significantly high.

**TABLE 4.5****Typical Operational Costs of Desalinated Seawater (US\$ per m<sup>3</sup>)**

	MSF	MED-TVC	SWRO
Operating costs 1998–2004	1.10–1.25	0.75–0.85	0.68–0.82
Operating costs 2006–08	0.65	0.54	0.47
Current study	—	0.67–0.96	0.58–0.88

Source: 1998–2004 data from World Bank 2004; 2006–08 based on data from GWI/DesalData 2010.

Note: — = not available.

### **Total costs of desalination**

Taking annualized capital costs and operating costs together indicates that the total cost of desalinated water ranges from US\$1.06 per m<sup>3</sup>–1.59 per m<sup>3</sup> depending on technology, energy costs, and project location (table 4.6).

The higher cost for SWRO in the Gulf reflects the additional cost of desalinating higher salinity seawater. Larger MSF plants have significant economies of scale. For example, the water production cost for the United Arab Emirates' Taweelah A2 MSF distiller is US\$0.84 per m<sup>3</sup>. The main reason for SWRO's lower costs, compared to MED's, is that SWRO does not require energy to heat the water. The energy cost for pumping is approximately US\$0.29 per m<sup>3</sup>. In comparison, MSF distillation energy costs total US\$0.77 per m<sup>3</sup>, of which US\$0.53 per m<sup>3</sup> is used for heating. Desalination costs are strongly case specific. Therefore, based on the foregoing analysis, it is reasonable to assume that MED and SWRO plants are more cost effective under most local conditions than MSF.

### **Desalination Will Increase MENA's Energy Demand**

Estimates of capacity and energy used in desalination for six of MENA's most water-stressed countries were presented as part of an International Energy Agency review (IEA and OECD 2005) (table 4.7). In 2010 the estimated energy requirements of desalination ranged from a low of 2.4 percent in Algeria to a high of 23.9 percent in the United Arab Emirates. For these six countries combined, the energy requirements of meeting desalination needs approximated 10 percent of their total primary energy use.

In the world's largest oil exporter, Saudi Arabia, desalination and electricity generation alone currently requires burning approximately 1.5

**TABLE 4.6**

#### **Total Annualized Cost of Desalinated Seawater (US\$ per m<sup>3</sup>)**

	MSF	MED	SWRO
Mediterranean Sea	—	1.36–1.59	1.08–1.32
Red Sea	—	1.28–1.43	1.06–1.23
Gulf water	0.84 (1.6)	1.21–1.34	1.23–1.36

Sources: Fichtner and DLR 2011; The United Arab Emirates' Regulation and Supervision Bureau 2009.

Note: MSF costs are based on actual contracted prices and electricity prices in the United Arab Emirates of US\$0.068 per kWh (United Arab Emirates 2009). The figure in parenthesis is the equivalent cost of desalination based on unsubsidized energy cost (that is, assuming the opportunity cost of fossil fuel at the international price of approximately US\$64.9 per MWh). For MED and SWRO, the costs are based on feasibility studies by Fichtner and DLR 2011 (assuming a project life of 25 years and discount rate of 6 percent). In this volume, energy costs for SWRO and MED were calculated based on the opportunity cost of fuel at the international price and fuel escalation cost of 5 percent per annum (see appendix C for more on the underlying assumptions adopted in this volume). Unit costs under MSF and MED or SWRO for the Gulf region are not comparable as they do not correspond to the same desalination plant. — = not available.

TABLE 4.7

### Estimated Installed Capacity and Primary Energy Use for Desalination in Selected MENA Countries, 2003–10

Country	2003			2010		
	Actual desalination capacity (MCM/year)	Estimated primary energy used (mtoe)	National primary energy used (%)	Anticipated desalination capacity (MCM/year)	Estimated primary energy used (mtoe)	National primary energy used (%)
United Arab Emirates	1,465	9	23.1	2,482	13	23.9
Kuwait	582	3	13.1	1,006	4	13.2
Saudi Arabia	2,207	11	8.5	3,523	17	9.4
Qatar	206	1	6.6	282	2	6.3
Libya	272	1	5.5	532	1	4.0
Algeria	125	0	0.0	542	1	2.4
Total	4,837	26	10.0	8,227	38	10.4

Source: IEA and OECD 2005.

Note: MCM = million cubic meters of water; mtoe = million tons of oil equivalent.

million barrels per day of crude equivalent. The trend is similar for other GCC countries as well as in the North African countries, such as Algeria and Libya, to whose water supply portfolios desalination contributes a significant share. As water demand continues to grow rapidly, so will the proportion of national energy demand that is devoted to desalinating water. Therefore, the status quo is not sustainable. For example, in Saudi Arabia, if energy efficiency is not improved and current trends continue, domestic fossil fuel demand is projected to reach over 8 million barrels per day (oil equivalent) by 2030. This quantity leaves very little oil for export, jeopardizing the economy of Saudi Arabia.

Across the region, the share of national water supply derived from desalination varies considerably. In aggregate, the total volume of desalination—approximately 9.2 km<sup>3</sup> a year—accounts for slightly more than 3 percent of total regional water demand. The annual electrical energy equivalent used totals 38.3 Tera-watt hours (TWh). This amount is equivalent to 4.1 percent of the total electricity generated in MENA in 2010. Again, these figures vary significantly among countries. The highest percentage of national electricity used for desalination was encountered in the Gulf countries. As demand for desalinated water grows, the most visible impact will be in the countries that currently use only a small proportion of their energy for desalination. Given that renewable water resources are being depleted while populations continue to grow, the region's rapidly increasing population is likely to accelerate water demand.

One interesting point in table 4.7 is that the proportion of primary energy used in desalination between 2003 and 2010 stayed at approximately 10 percent. This stability could be explained partially by an increase in energy efficiency of desalination technologies during 2003–10

and by the simultaneous growth of energy demand in other sectors such as air conditioning.

### Can Energy Intensity of Desalination Be Reduced?

The energy requirements of desalination account for 33–50 percent of the total cost of desalinated water (figure 4.6). While the maturation of the MSF technology significantly lowered the unit cost of water over the last 40 years (figure 4.7), opportunities for future cost reductions in both the MSF and MED processes are most likely to occur through the increased recovery of energy from the brine stream. Moreover, unlike MSF, which has reached its technological maturity, MED technology has the potential for additional technological development.

Similarly, since the 1970s, RO energy consumption has decreased almost 10-fold (figure 4.8). Even so, RO’s current energy consumption of 1.8 kWh per m<sup>3</sup> is approaching the theoretical minimum energy required to separate pure water from seawater: 1.06 kWh per m<sup>3</sup> (Elimelech and Philip 2011). To this amount must be added the energy required for intake, pretreatment, post-treatment, and brine discharge: in most cases more than 1 kWh per m<sup>3</sup>. Since 1996, continuous RO innovation in pretreatment, filter design, and energy recovery has reduced the energy consumption per unit of water by a factor of four. Additional innovations may be expected.<sup>4</sup> Energy comprises almost 50 percent of the total annual costs for MSF and MED, and 33 percent for RO. Thus, reducing energy use and/or using cheaper energy would be among the most effective ways of reducing the cost of desalinated water.

FIGURE 4.6

#### Components of Total Annual Desalination Costs

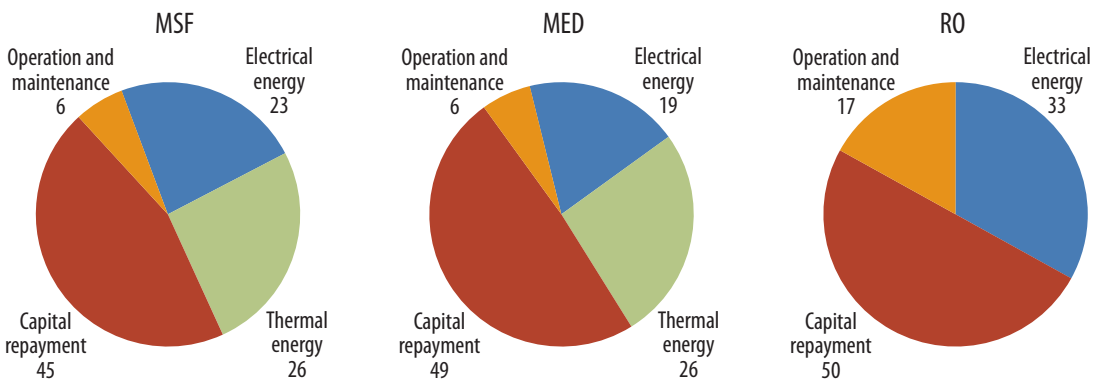

Source: Adapted from Borsani and Rebagliani 2005.

Note: No thermal energy is needed for RO.

**FIGURE 4.7**

**Reduction in MSF Desalination Cost, 1955–2005**

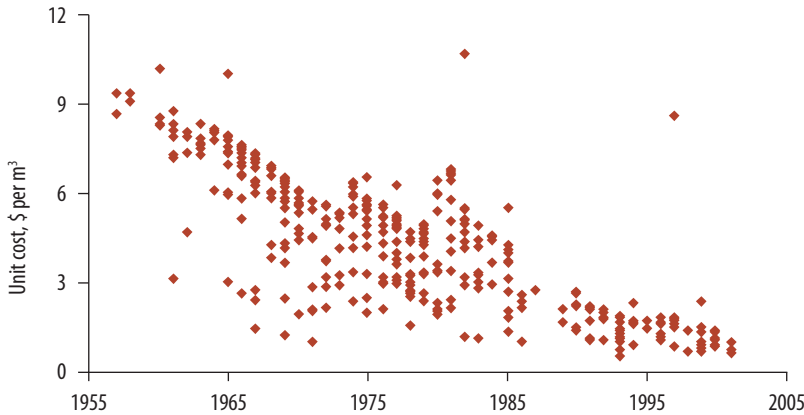

Source: Zhou and Tol 2005.

Note: Desalination costs are based on subsidized energy cost.

**FIGURE 4.8**

**Reduction in RO Power Consumption, 1970–2010**

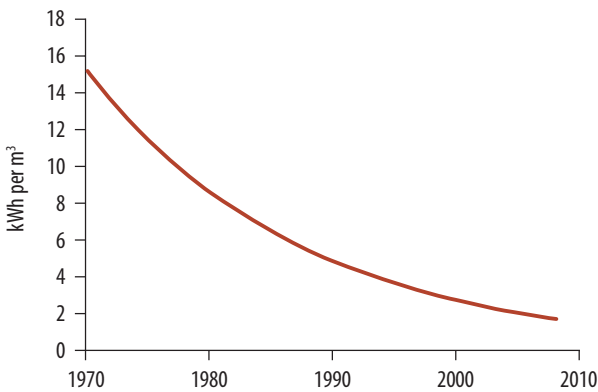

Source: Adapted from Elimelech and Phillip 2011.

As stressed above, given the ever-increasing water demand and associated energy use, reliance on conventional energy for desalination will not be sustainable. To ensure the sustainable provision of water supply to the region into the future, alternative sources of energy should be sought now. Alternative energy sources are the subject of the next section.

## MENA's Renewable Energy Potential

At present, RE makes up less than 4 percent of MENA's primary energy balance. The limited contribution of RE in MENA contrasts sharply with the trend in the rest of the world, which has witnessed a rapid growth in the deployment of RE to 16 percent of global final energy consumption (REN21 2011). This relatively large share of RE is attributable not to any single renewable resource, but to the deployment of a number of renewable resources (IPCC 2011). Globally, RE potential far exceeds energy demand.

As with the rest of the world, MENA's rich endowment of RE resources exceeds its annual energy needs. In 2010 the region's energy demand was approximately 1,121 TWh. By 2050, this demand is projected to increase to approximately 2,900 TWh (Fichtner and DLR 2011). Only recently has tapping renewable resources across the region been accorded priority. Efforts to make use of this potential will require additional technological improvements, cost reductions, and the adoption of favorable policy regimes. MENA countries are at the beginning of their journey to revolutionize their energy systems using renewable sources. The potential of the major RE sources in the MENA Region is summarized below.

### Hydroelectric Power

The best known and most commercially established RE resource is the hydropower used to generate hydroelectricity. Traditionally generated along rivers by the force of flowing water, hydroelectricity remains the largest global RE source. However, in the MENA Region, the same wa-

#### MAP 4.1

### Gross Hydropower Potential (GWh)

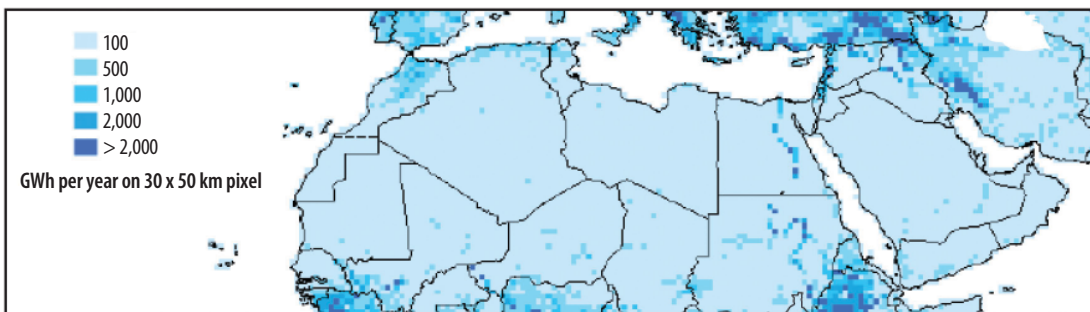

Source: Modified by DLR from Lehner and others 2005.

ter scarcity that presents a challenge to continued economic growth and human settlement presents limited opportunities for commercial hydroenergy exploitation (Map 4.1). At present, hydropower supplies less than 2.5 percent of the region's electricity.

Clearly, compared to more mountainous regions throughout Europe, the Ethiopian Highlands, and the Guinea Highlands, the MENA Region has limited hydropower potential. The greatest technical potential for hydro development in the region can be found in Egypt, the Islamic Republic of Iran, and Iraq. Throughout the rest of the region, water scarcity limits the potential for hydroelectric development. On the basis of the combined country-specific potential, approximately 182 TWh per year of electricity could be generated in the region if the known hydropower resources were exploited using current technologies. This amount could cover nearly 16 percent of current electricity supplies in the region.

## Wind Power

Global forces largely determine local wind speeds. Although some localized geographic features, such as mountain passes or proximity to coasts, may increase or decrease local wind velocities, broader geographic concerns largely shape prevailing wind direction and strength. Map 4.2 presents an approximation of wind speed in MENA. Greater interest in harnessing wind energy and the availability of advanced technology has resulted in commercially exploitable wind resources being found at more locations in the world.

### MAP 4.2

#### Annual Average Wind Speed at 80 m above Ground (m/sec)

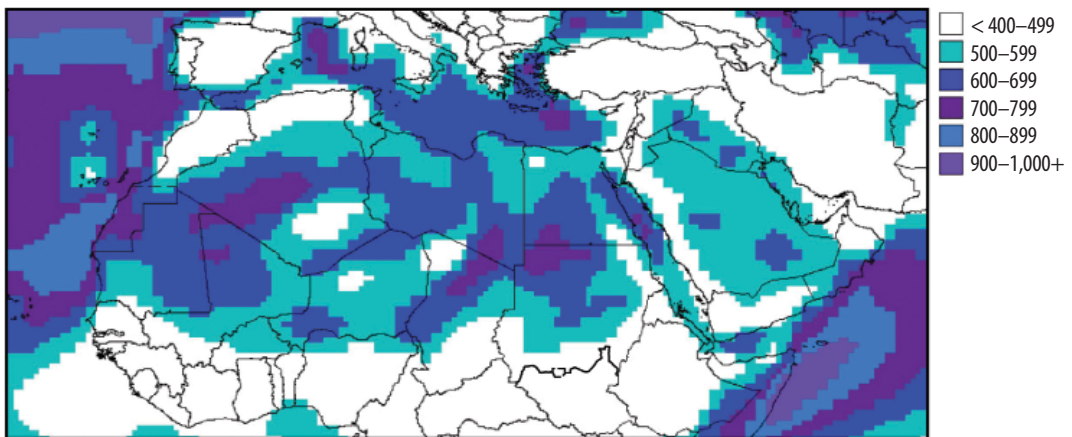

Source: Fichtner and DLR 2011.

In the MENA Region, wind is being exploited along the coast of North Africa, especially in Morocco, Algeria, and Egypt. Although all of these countries have begun programs to develop wind resources, as interest throughout the region expands, wind development likely will be taken up by other countries as well. The total estimated economic potential of wind energy in the region is estimated at 300 TWh, or slightly more than 25 percent of MENA's current electricity consumption. As wind exploration becomes more widespread and the technology improves to better harness lower-velocity wind speeds, the estimated wind potential of the region doubtless will increase.

### **Biomass**

Biomass productivity varies across the earth's surface as a function of surface temperature, solar energy, and rainfall or available moisture. Unfortunately, biomass supplies in MENA are limited by the same water or moisture deficit that shapes so much of life throughout the region. In all but a small part of the Mediterranean coast, primary annual biomass productivity falls below 2.5 tons per ha. Historically, irrigation from the major river systems in Egypt and Iraq relieved this constraint to biomass productivity, enabling the Tigris and Nile River valleys to support early human civilizations. However, future potential is limited. MENA's total biomass energy supplies are estimated at 111 TWh per year including agricultural waste, existing forest production, and municipal solid waste.

### **Geothermal Power**

Geothermal power utilizes the temperature differential between the earth's surface and subsurface to turn water into steam to generate electricity. Temperature differentials exceeding 180°C are required to produce the necessary steam. In the more geologically active parts of the earth, such as the Rift Valley in eastern Africa or the "Ring of Fire" around the East Asia and Pacific Region, dramatic temperature differences sufficient to generate electricity are located a few hundred meters below the earth's surface. In other less active sites, drilling as deep as 5,000 m is necessary to find sufficient temperature differential. Confirming that these resources are sufficiently strong and sufficiently accessible to support geothermal electricity generation requires expensive drilling and testing. As with other RE resources, the operational and fuel costs of generating using geothermal energy are quite low, but the upfront resource confirmation costs are extremely high and often prohibitive to private developers.

Geothermal energy in MENA is most common in the parts of the region located near the northern extension of the Great Rift Valley, namely

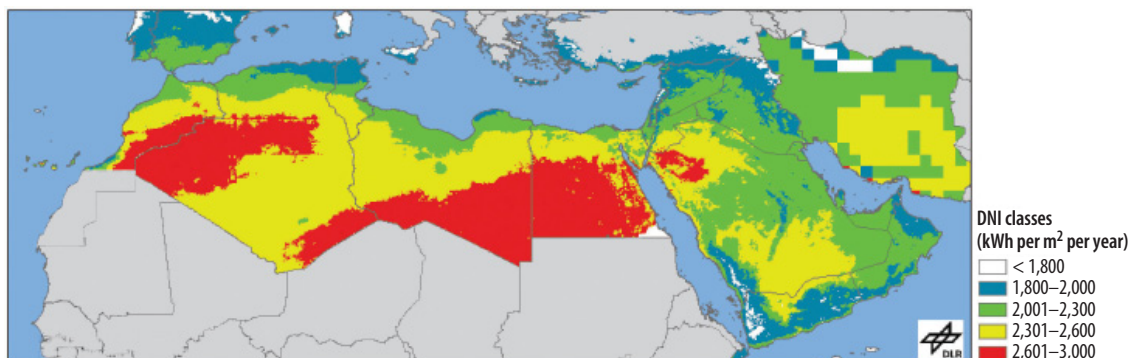

**MAP 4.3****Annual Sum of Direct Normal Irradiation, 2011**

Source: Fichtner and DLR 2011. Iran DNI data originally from NASA 2008 (<http://eosweb.larc.nasa.gov/sse/>); Djibouti DNI data original NREL 2011 ([http://www.nrel.gov/csp/troughnet/solar\\_data.html#international](http://www.nrel.gov/csp/troughnet/solar_data.html#international)).

Note: Solar energy is measured as direct normal irradiance (DNI) expressed as kilowatt-hours per square meter per year.

Egypt, Saudi Arabia, the Republic of Yemen, and Djibouti. The estimated combined annual geothermal potential of the region is approximately 300 TWh of electricity per year, or slightly more than 25 percent of the region's current electricity consumption. Typical geothermal electric plants can operate as baseload plants but normally do not exceed 100 W installed capacity per site.

**Direct Solar Energy: Concentrating Solar Power and Photovoltaic**

Between 22 percent and 26 percent of the total solar energy striking the earth's land mass is estimated to fall in the MENA region. Map 4.3 presents the distribution of solar energy across the entire MENA region in 2011.

Map 4.3 demonstrates that the solar energy striking the earth's surface exceeds 2,000 kWh per m<sup>2</sup> per year throughout much of the region. Clearly, MENA's potential solar energy is higher than in any other region in the world. However, not all of this potential energy is usable because much of the land's surface is being used in ways that prohibit dedicating it to solar energy harvesting.<sup>5</sup> Two technologies exist for converting direct solar energy to electricity: concentrating solar power (CSP) and photovoltaic (PV) power. The potential of each is assessed below.

CSP potential in MENA was determined based on the DNI excluding all land areas that are unsuitable for the erection of solar fields.<sup>6</sup> A final screening was done to ensure that sites classified as viable for CSP are large enough to accommodate the solar collector array: typically approximately 4 km<sup>2</sup>.<sup>7</sup> The physically feasible areas for CSP are shown in map 4.4; the white areas represent the excluded areas. Based on this assess-

## MAP 4.4

### Concentrating Solar Power Potential in the MENA Region, 2011

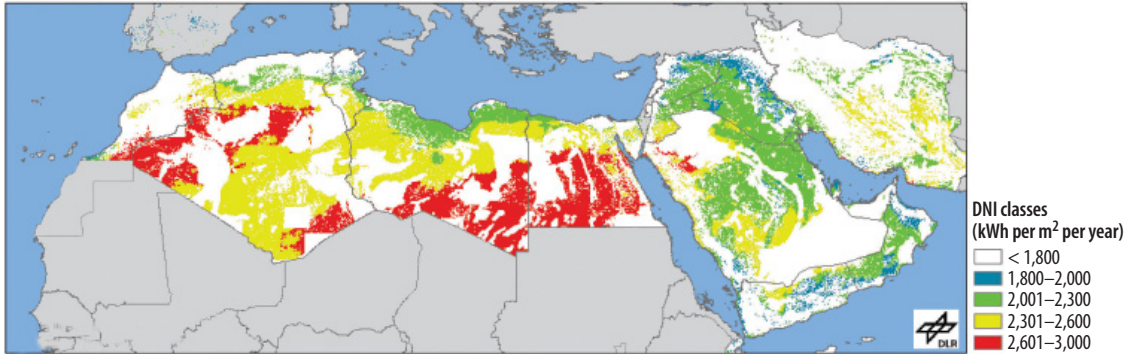

Source: Fichtner and DLR 2011.

Note: Solar energy is measured as DNI expressed as kilowatt-hours per square meter per year.

ment, MENA's total CSP potential comes to over 462,000 TWh per year—exceeding by more than 350 times the region's current annual energy consumption. In fact, MENA's CSP potential represents more than 20 times the primary energy utilized annually by the entire world. In terms of water production in MENA, a 10 km × 10 km concentrating thermal collector array will produce 1 km<sup>3</sup> of desalinated water per year.<sup>8</sup>

The estimation of MENA's PV energy potential makes use of the same solar irradiance data as the CSP assessment (although PV assessment was based on the global irradiance data as opposed to CSP's DNI). However, because PV does not lend itself to thermal energy storage, its potential is considerably lower than that calculated for CSP. Nonetheless, the PV potential in the region comes to 356 TWh per year, or approximately 31 percent of MENA's current total electricity use. Clearly, MENA's solar energy potential is without parallel, and if properly harnessed, eventually can fuel all of the region's energy needs.

### Cost of Renewable Energy

Table 4.8 summarizes the potential renewable electricity resources in the MENA Region. CSP has a potential more than 200 times the likely electricity demand for MENA in 2050 (table 4.8). Despite its significant potential, CSP is not economically competitive today compared to conventional energy sources and most RE technologies such as wind and PV (table 4.9). Combining RE in general and CSP in particular with desalination (which is already an expensive water supply option) will make the cost of desalinated water even more expensive. However, CSP technology has a particular significance to utilities because it is more scalable and

**TABLE 4.8****Estimated Renewable Electricity Potential for MENA Countries  
(TWh per year)**

Country	CSP	PV	Wind	Geothermal	Hydropower	Biomass
Algeria	135,771	20.9	35	4.7	0.5	12.3
Libya	82,714	7.8	15	0.0	0.0	1.8
Saudi Arabia	75,832	20.8	20	70.9	0.0	10.0
Egypt, Arab Rep.	57,140	54.0	125	25.7	50.0	14.1
Iran, Islamic Rep.	32,134	54.0	12	11.3	48.0	23.7
Iraq	24,657	34.6	20	0.0	67.0	8.8
Oman	14,174	4.1	8	0.0	0.0	1.1
Yemen, Rep.	8,486	19.3	3	107.0	0.0	9.1
Syrian Arab Republic	8,449	17.3	15	0.0	4.0	4.7
Morocco	8,428	17.0	35	10.0	4.0	14.3
Jordan	5,884	6.7	5	0.0	0.1	1.6
Tunisia	5,673	3.7	8	3.2	0.5	3.2
Kuwait	1,372	3.8	n.a.	0.0	0.0	0.8
Qatar	555	1.5	n.a.	0.0	0.0	0.2
United Arab Emirates	447	9.0	n.a.	0.0	0.0	0.7
Djibouti	300	50.0	1.0	0.0	0.0	0.0
Israel	151	6.0	0.5	0.0	7.0	2.3
Bahrain	16	0.5	0.1	0.0	0.0	0.2
Gaza and West Bank	8	20.0	0.5	0.0	0.0	1.7
Lebanon	5	5.0	1.0	0.0	1.0	0.9
Malta	0	0.2	0.2	0.0	0.0	0.1
Total	462,196	356.0 <sup>a</sup>	304.0	233.0	182.0	111.0

Source: Fichtner and DLR 2011.

Note: For geothermal, areas were considered exploitable if the temperature differential at 5,000 m depth exceeded 180°C. Biomass includes potential from agricultural waste (especially sugarcane biogas), solid biomass, and municipal waste. CSP includes production from viable sites with DNI greater than 2,000 kWh per m<sup>2</sup> per year. Wind potential is drawn from identified sites with a potential annual generation exceeding 14 GWh per km<sup>2</sup> per year.

a. This volume applies restrictions from demand and grid integration to calculate PV potential.

**TABLE 4.9****LECs of CSP and Other Technologies**

Energy source	CSP	Wind	PV	Combined cycle gas turbine	Simple cycle gas turbine
LEC (US\$/MWh)	196	102	100	80	116

Source: World Bank 2009.

Note: LEC (levelized electricity cost) calculation is based on 25 years of plant economic life and a 10 percent discount rate.

more consistent with a centralized and dispatchable generation model. CSP also is a technology that has yet to benefit from significant unexploited manufacturing scale economies, which would make it more competitive in the long run.

CSP will continue to need strategic support to mature and become cost effective. Such strategic support could combine energy policy reforms to eliminate barriers, such as eliminating fossil fuel subsidies, creating the enabling environment for long term power-purchase agreements and feed-in tariffs, and supporting initial investments and R&D related to CSP. The strategic support for CSP also could come in the form of a targeted subsidy to CSP-based energy sources to encourage its rapid development and cost-competitiveness with other sources. If appropriate measures are taken, a reduction of 45–60 percent in the LEC for CSP is projected for 2030. This reduction will be achieved through a combination of economies of scale (21–33 percent), efficiency increases (10–15 percent), and technology improvements (18–22 percent). The next chapter will provide the potential for RE desalination linkages in general, and CSP desalination in particular, in MENA.

## Notes

1. With the exception of West Bank, which also could be supplied with desalinated water with pipes from Gaza.
2. GCC comprises the countries on the Arabian Peninsula: Bahrain, Saudi Arabia, Kuwait, Qatar, Oman, and the United Arab Emirates.
3. The widely used desalination technologies can be divided in two process groups: (a) *thermal distillation*, which uses heat to evaporate water, leaving behind the salts in the brine; and (b) *membrane process*, which uses pressure to force water through a semipermeable membrane that blocks salts and other dissolved solids. The most common thermal processes are MSF, MED, and vapor compression (VC). The most common membrane technologies are RO and micro-, ultra, and nano-filtration (MF/UF/NF).
4. <http://ec.europa.eu/environment/etap>.
5. Solar electricity potentials were calculated from the annual DNI with a conversion factor of 0.045, which takes into account an average annual efficiency of 15 percent and a land use factor of 30 percent for the respective CSP technology. These values correspond to present state-of-the-art parabolic trough power plants.
6. Exclusion criteria fall into at least eight categories: (1) terrain is too rugged (slope greater than 2.1 percent); (2) land use and land cover for agriculture, forestry, or other uses is considered necessary for continued development; (3) population settlement density is greater than 50 persons per km<sup>2</sup>; (4) surface is covered by a fresh-water body; (5) geomorphology is unstable; (6) is a protected area; (7) hosts essential infrastructure; and (8) fails to meet technical design requirements, such as having a minimum contiguous land area of 4 km<sup>2</sup> or being located more than 5 km offshore.
7. In the analysis, a typical CSP plant is a 100 MW parabolic trough power plant with a solar multiple (SM<sub>2</sub>). Such plants have a dimension of approximately 4 km<sup>2</sup>.

8. Corresponding to approximately 10 m<sup>3</sup> of desalinated water per m<sup>2</sup> of collector area.

## References

- Borsani, R., and S. Rebagliati. 2005. "Fundamentals and Costing of MSF Desalination Plants and Comparisons with Other Technologies." *Desalination* 182: 29–37. Presented at the Conference on Desalination and the Environment, Santa Margherita, Italy, May 22–26. <http://www.desline.com/articoli/6641.pdf>.
- Economist*. 2008. "Tapping the Oceans. Environmental Technology: Desalination Turns Salty Water into Fresh Water. As Concern over Water's Scarcity Grows, Can It Offer a Quick Technological Fix?" *Technology Quarterly*. June 5. <http://www.economist.com/node/11484059>.
- Elimelech, M., and W. A. Phillip. 2011. "The Future of Seawater Desalination: Energy, Technology, and the Environment." *Science* 5 (333): 712–17.
- Fichtner and DLR. 2011. *MENA Regional Water Outlook, Part II, Desalination Using Renewable Energy, Task 1–Desalination Potential; Task 2–Energy Requirements; Task 3–Concentrate Management*. Final Report, commissioned by the World Bank, Fichtner and DLR. [www.worldbank.org/mna/watergap](http://www.worldbank.org/mna/watergap).
- FutureWater. 2011. *Middle-East Northern Africa Water Outlook. Final Report*, commissioned by the World Bank, W. Immerzeel, P. Droogers, W. Terink, J. Hoogeveen, P. Hellegers, and M. Bierkens (auth.). Future Water Report 98, Wageningen, the Netherlands. [www.worldbank.org/mna/watergap](http://www.worldbank.org/mna/watergap).
- GWl (Global Water Intelligence). 2010. *GWl Desalination Market Forecast March 2010: DesalForecastMarch2010.xls*. Oxford. <http://www.globalwaterintel.com>.
- IEA (International Energy Agency) and OECD (Organisation for Economic Cooperation and Development). 2005. *World Energy Outlook 2005, Middle East and North Africa Insights*. Paris: IEA. <http://www.iea.org/weo/docs/weo2005/WEO2005.pdf>.
- IPCC (Intergovernmental Panel on Climate Change). 2011. "Final Release, Working Group III–Mitigation of Climate Change." In *Special Report on Renewable Energy Sources and Climate Change Mitigation*, ed. O. Edenhofer, R. Pichs-Madruga, Y. Sokona, K. Seyboth, P. Matschoss, S. Kadner, T. Zwickel, P. Eickemeier, G. Hansen, S. Schlömer, and C. von Stechow. New York: Cambridge University Press. [http://srren.ipcc-wg3.de/report/IPCC\\_SRREN\\_Full\\_Report.pdf](http://srren.ipcc-wg3.de/report/IPCC_SRREN_Full_Report.pdf).
- Lattemann S. 2010. "Development of an Environmental Impact Assessment and Decision Support System for Seawater Desalination Plants." Ph.D. thesis, CRC Press/Balkema, 276 p. <http://repository.tudelft.nl/search/ir/?q=lattemann&faculty=&department=&type=&year>.
- Mohsen, M. S., and O. R. Al-Jayyousi. 1999. "Brackish Water Desalination: An Alternative for Water Supply Enhancement in Jordan." *Desalination* 124: 163–74.

- REN21. 2011. *Renewables 2011 Global Status Report*. Paris: REN21 Secretariat. [www.ren21.net/Portals/97/documents/GSR/REN21\\_GSR2011.pdf](http://www.ren21.net/Portals/97/documents/GSR/REN21_GSR2011.pdf).
- United Arab Emirates. 2009. *Switched on*. Annual Report for the Water, Wastewater and Electricity Sector in the Emirate of Abu Dhabi. Dubai: The Abu Dhabi Regulation and Supervision Bureau. <http://www.rsb.gov.ae/uploads/AnnualReport2009.pdf>.
- World Bank. 2004. *Seawater and Brackish Water Desalination in the Middle East, North Africa and Central Asia: A Review of Key Issues and Experiences in Six Countries*. Final and Main Report, prepared by a consortium of consultants, consisting of DHV Water BV, Amersfoort, the Netherlands, and BRL Ingénierie, Nimes, France. December. [http://siteresources.worldbank.org/INTWSS/Resources/Desal\\_mainreport-Final2.pdf](http://siteresources.worldbank.org/INTWSS/Resources/Desal_mainreport-Final2.pdf).
- World Bank. 2009. *Clean Technology Funds Investment Plan for Concentrated Solar Power in the Middle East and North Africa Region*. Washington, DC: Inter-Sessional Meeting of the Clean Technology Fund Trust Fund Committee, World Bank.
- Zhou, Y., and R. S. J. Tol. 2005. "Evaluating the Costs of Desalination and Water Transport." *Water Resources Research*, 41, 1–10.

# Potential for Renewable Energy Desalination

Coupling renewable energy (RE) sources with desalination has the potential to provide a sustainable source of potable water. Moreover, coupling these two technologies will alleviate the carbon footprint of desalination due to its heavy reliance on fossil fuel. A wide variety of options are available to link RE and desalination technologies. Each combination of technologies has its own merits in terms of scope of water production, 24-h availability of RE sources to power desalination plants, and cost. Chapter 5 reviews potential RE desalination linkages for the world in general, and for the MENA Region in particular. Currently, RE desalination is more costly than conventional energy desalination and requires some level of strategic intervention to be a competitive option. This chapter also provides a strategic approach to roll out the adoption of CSP desalination in MENA.

## Factors Affecting Renewable Energy Desalination Linkages

### Technology Choices

#### *A wide variety of combinations link RE and desalination technologies*

Between 1974 and 2009, 131 RE desalination plants were installed worldwide (ProDes 2010). Excluding wave power, these 131 plants comprise eight different combinations of RE and desalination. Three use RE heat generated from solar collectors; PV may power RO or electro dialysis reversal (EDR) plants; and wind power is linked to either RO or mechanical vapor compression (MVC) plants. When the 131 plants are categorized by energy source, solar heat is the most common, followed by PV (figure 5.1). The primary reason that solar heat and PV are the preferred energy sources is that solar energy is *more predictable*.

FIGURE 5.1

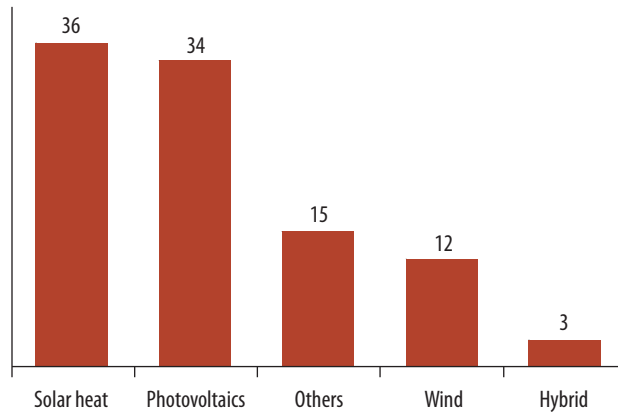
**Global Renewable Energy Desalination by Energy Source, 2009 (percent)**

Source: ProDes 2010.

Other factors influencing the RE desalination linkage are the level of technological development and the scale of the application. For example, solar stills are a very well-known technology with few problems, but they suffer from capacity limitations. Most solar stills produce fewer than 100 liters of desalinated water per day so are most appropriate at the household level.<sup>1</sup> Photovoltaics linked to either RO or EDR typically produce up to 100 m<sup>3</sup> per day. This amount is suitable only for small communities. In contrast, wind-generated electricity-RO combinations can produce 50–2,000 m<sup>3</sup> per day. They are suitable at the village/hotel level and are better suited to islands and exposed coasts, where winds are more predictable, than inland sites, where they are not. Only large arrays of CSP have the potential to economically produce thermal and electrical power sufficient to produce desalinated water in excess of the 5,000 m<sup>3</sup> per day that could supply towns and cities.

To produce energy, most CSP technologies require water (for cooling and steam generation), as opposed to PV and wind technologies, which do not. Requiring water may be a limiting factor, especially in the MENA countries in which water is extremely scarce. As a workaround, for water-scarce cases, it is possible to use dry (air) cooling using air instead of water. The downside of using dry air cooling is that during hot days (especially when the ambient temperature is above 32°C), poor performance of the air-cooled condenser affects the turbine's efficiency and output.<sup>2</sup> To mitigate such efficiency losses, various cooling options are being considered. One option is hybrid-cooling using a 25 percent capacity wet cooling tower and 100 percent capacity dry cooling tower, in which case part of



the turbine steam exhaust is reverted to the wet cooling tower when the ambient temperature rises. Compared to a 100 percent dry cooling tower, the hybrid option improves efficiency with little loss of capacity. The hybrid wet cooling tower is used only on hot days, thus using only 10 percent of the water normally required by a wet cooling tower.<sup>3</sup>

From the desalination perspective, most utility-scale desalination technologies operate continuously, rendering most RE supply options unfit for direct energy supply. Only a few desalination technologies allow their operational capacities to go as low as 60 percent, permitting a certain level of flexibility to be linked to fluctuating RE power (table 4.2). Moreover, in this volume, given MSFs higher energy requirement compared to MEDs, “plain” MED has been selected for further analysis (linkage with RE). For membrane desalination, RO has been selected.

CSP-MED and wind-RO can produce large volumes of desalinated water. They also are among the least costly RE sources when capital, operations, and maintenance costs are included (table 5.1). In contrast, PV produces relatively small volumes of water at two to three times the cost of solar thermal and wind energy.

### Adequate Energy Availability

Availability of adequate energy when and where needed is a critical factor when linking RE and desalination. All the RE sources considered could be scaled up to produce excess electricity that could be either sold to the grid or used for pumped storage in locations with hydroelectricity potential. However, as noted earlier, MENA’s hydropotential is low, and pumped storage is not generally an option available to most MENA countries. Solar and wind energy sources also are subject to natural fluctuations that, at first glance, would make them seem unsuitable as a reliable power source for desalination plants (figure 5.2). However, the abil-

**TABLE 5.1**

### Costs of Desalinated Seawater from Renewable Energy Alternatives

RE source	Solar heat			PV			Wind	
Desalination technology	CSP-MED	MEH	Stills	EDR	RO	MVC	RO	
Production (m <sup>3</sup> /day)	>5,000	1–100	<0.1	<100	<100	<100	50	1,000
Cost (€/m <sup>3</sup> )	1.8–2.2	2–5	1–15	8–9	9–12	4–6	5–7	1.5–4.0

Source: After ProDes 2010, table 1.2.

Note: €1.0 = US\$1.40; EDR = electro dialysis reverse; MEH = multi-effect humidification; MVC = mechanical vapor compression.

**FIGURE 5.2**

**Renewable Energy Production from Photovoltaics, Wind, and Concentrating Solar Power at Hurghada Site, Egypt, Arab Rep.**

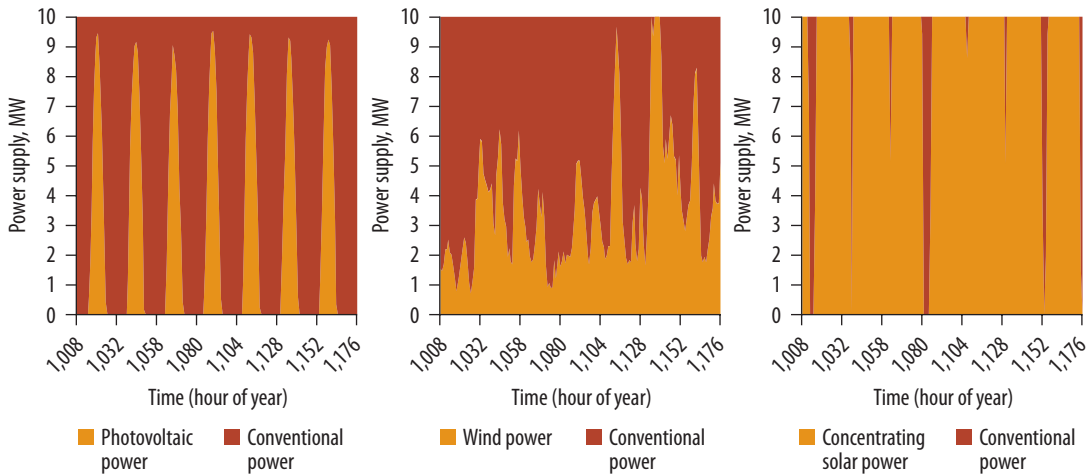

Source: Fichtner and DLR 2011.

ity to either store energy produced and/or have a large number of RE generation sites connected to the grid can make all the difference. On average, a large number of dispersed RE sites would produce a fairly even flow of wind energy day and night. Although solar radiation is far more predictable, it is not available at night. Furthermore, only CSP has economically viable storage potential for solar RE. Figure 5.2 shows the amount of RE generated (yellow) and the additional backup grid electrical power (blue) required to ensure a constant 10 MW power supply to a Hurghada, Egypt, Arab Rep., desalination plant.

A key advantage of CSP over other RE technologies such as PV and wind is that CSP can store and retrieve generated excess heat in associated thermal energy storage systems with very high efficiency (table 5.2, box 5.1). CSP thus potentially can produce baseload power. As a result, fossil fuel consumption could be reduced by over-sizing the solar collector field and storing a portion of the heat. The surplus solar energy stored could be used during evenings or nights and to compensate for short-term solar irradiation fluctuations caused by clouds and dust. In principle, around-the-clock solar operation is possible. In the Hurghada example, CSP provided 90 percent of the energy, wind 35 percent, and PV only 25 percent. The CSP solar collector had 16 h of storage, which provided 24-h energy supply. Table 5.2 also compares various thermal storage technologies.

TABLE 5.2

### Comparison of Principal Features of Solar Thermal Storage Technologies

Technology	Molten salt	Concrete	Phase change material	Water/steam	Hot water
Capacity range (MWh)	500–>3,000	1–>3,000	1.0–>3,000	1–>200	1–>3,000
Realized max. capacity of single unit (MWh)	1,000	2	0.7	50	1,000
Realized max. capacity of single unit (full load hours)	7.7	Not yet applied to CSP plants	Not yet applied to CSP plants	1	Not yet applied to CSP plants
Capacity installed (MWh)	4,100.0	3	0.7	50	20,000 (not for CSP)
Annual efficiency (%)	98	98	98	90	98
Heat transfer fluid	Molten salt	Synthetic oil, water, steam	Water/steam	Water/steam	Water
Temperature range (°C)	290.0–390.0	200–500	Up to 350.0	Up to 550	50–95
Investment cost (€/kWh)	40–60	30–40 (20 projected)	40–50 projected	180	2–5
Advantages	High storage capacity at relatively low cost. Experience in industrial applications. Well suited for synthetic oil heat transfer fluid.	Well suited for synthetic oil heat transfer fluid. Easily available material. Well suited for preheating and superheating in direct steam generating collectors.	Latent heat storage allows for constant temperature at heat transfer. Low material requirements. Well suited for evaporation/condensation process in direct steam generating collectors.	Latent heat storage allows for constant temperature at heat transfer. Experience in industrial applications. Well suited for evaporation/condensation process in direct steam generating collectors.	Very low-cost storage for process heat below 100°C. Experience in industrial applications.
Disadvantages	Sensible heat storage requires temperature drop at heat transfer. Molten salt freezes at 230°C.	Not suited for evaporation/condensation process in direct steam generating collectors. Recent development.	Not suited for preheating and superheating in direct steam generating collectors. Early stage of development.	Not suitable for preheating and superheating.	Sensible heat storage requires temperature drop at heat transfer. Not applicable to power generation.

Source: Fichtner and DLR 2011.

**BOX 5.1****GemaSolar Central Receiver Plant Project, Fuentes de Andalucía, Spain**

Central receiver (tower) systems are large-scale power plants in which two-axis tracking mirrors, or heliostats, reflect direct solar radiation onto a receiver located at the top of a tower. The typical optical concentration factor ranges from 200 to 1,000. The solar energy is converted into thermal energy in the receiver and transferred to a heat transfer fluid (air, molten salt, water/steam), which in turn, drives a conventional steam or gas turbine.

The main goal of the GemaSolar project (formerly Solar Tres) is to demonstrate the technical and economic viability of molten salt solar thermal power technologies to deliver clean, cost-competitive bulk electricity. GemaSolar consists of a 17 MW plant that uses a central receiver with innovative solutions for the energy storage system.

**BOX FIGURE 5.1.1****GemaSolar CSP Plant: Construction Status, September 2010**

Source: Torresol Energy 2011.

In comparison with other RE sources, CSP has a number of significant advantages:

- CSP is more scalable to any application both large and small. It has a particular significance to utilities due to its scalability as well as its more consistent energy supply with centralized and dispatchable generation model.
- It could potentially provide both electrical baseload and heat as required, and the heat can be readily stored.
- Its potential in MENA significantly exceeds any foreseeable regional demand even when quite onerous site conditions are required.
- It has significant potential for future development, thereby reducing cost.

**BOX 5.1 (continued)**

Salt at 290°C is pumped from a tank at ground level to the receiver mounted atop a tower, where it is heated by concentrated sunlight to 565°C. The salt flows back to ground level into another tank. To generate electricity, hot salt is pumped from the hot tank through a steam generator to produce superheated steam, which is used to produce electricity in a steam turbine generator. The molten salt heat storage system permits an independent electrical generation for up to 15 h with no solar feed.

Total project costs: Approximately €230 million.

**BOX FIGURE 5.1.2**

**SolarTres Model Sketch and Design Features**

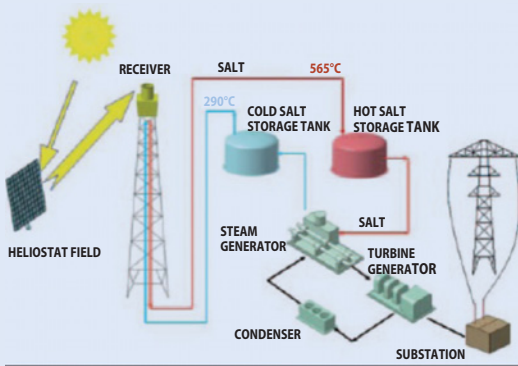

**SOLAR TRES-DESIGN FEATURES**

Location	Ecija, Spain
Receiver thermal power	120 MW
Turbine electrical power	17 MW
Tower height	120 m
Heliostats	2,480
Surface of heliostats	285,200 m <sup>2</sup>
Ground area covered by heliostats	142.31 ha
Storage size	15 h
Natural gas boiler thermal capacity	16 MW
Annual electricity (best available technology)	96,400 MWh
CO <sub>2</sub> mitigation (best available technology)	23,000 tons/year
CO <sub>2</sub> mitigation (coal power plant)	85,000 tons/year

Source: Terresol energy 2011.

- Most importantly, it works well with current large-scale desalination technologies.

The next section demonstrates that CSP is the subject of considerable research to improve collection efficiency and reduce costs.

**CSP and Desalination Plant Design Considerations**

A CSP power plant generally consists of three parts: a solar field, thermal energy storage, and a power system (block) that can produce electricity or heat or both (figure 5.3). To ensure continuous power supply for desalination, different CSP thermal storage configurations are possible. They range from single solar multiple (SM)<sup>4</sup> to four solar multiple (SM4) stor-

FIGURE 5.3

## Storage System in a Trough Solar Plant

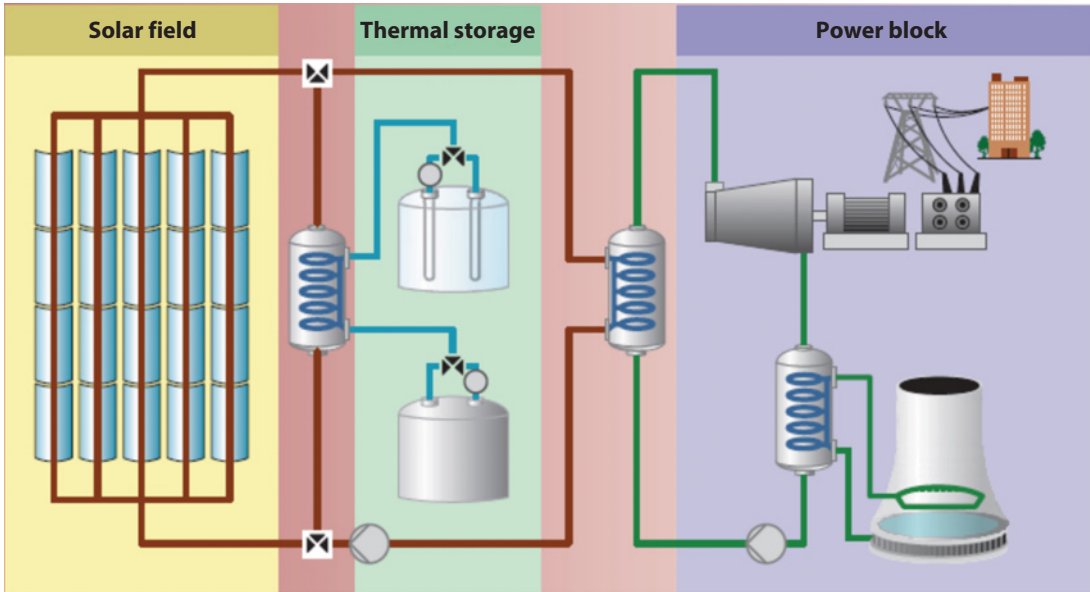

Source: Solar Millennium 2011.

Note: Figure 5.3 shows how storage works in a CSP plant. Excess heat collected in the solar field is sent to the heat exchanger and warms the molten salts going from the cold tank to the hot tank. When needed, the heat from the hot tank can be returned to the heat transfer fluid and sent to the steam generator.

age models (figure 5.4). The annual full load hours that can be supplied by CSP vary based on the level of thermal storage, latitude, and annual solar irradiation (DNI). Table 5.3 provides the annual full load hours that can be provided using CSP in MENA as a function of SM, latitude, and DNI. The main innovations are in the design of the solar collectors and heat transfer systems. Actual power generation uses well-proven technologies: steam turbines and superheated steam powering a Rankine cycle generator.

Three types of solar collectors are utilized for large-scale power generation<sup>5</sup>:

1. *Parabolic trough* systems use parabolic mirrors to concentrate solar radiation on linear receivers, constituted of a special coated steel tube and a glass envelope to minimize heat losses. The receiver moves with the parabolic mirror to track the sun from east to west. The collected heat is transferred to a heat transfer fluid—usually synthetic oil or water/steam—that flows through the absorber tube. The fluid is either (a) fed to the steam generator of a conventional Rankine cycle to directly produce electricity or (b) stored in the thermal energy storage.
2. *Linear Fresnel systems are simple designs.* They cost less than parabolic troughs but have lower conversion efficiencies. In a Fresnel system,

FIGURE 5.4

### Different Configurations of CSP Thermal Storage

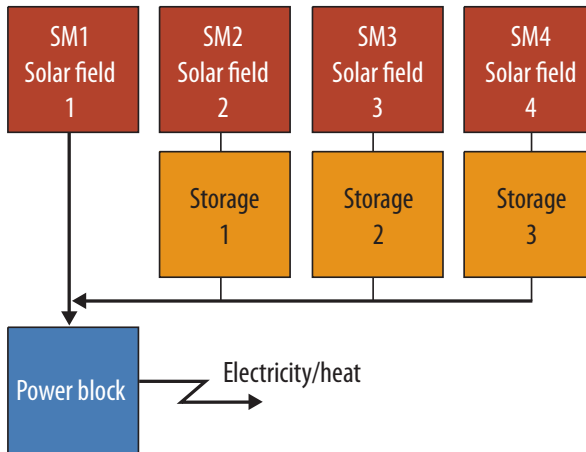

Source: Modified from Fichtner and DLR 2011.

Note: In the model, a solar multiple of 1 (SM1) defines a collector field with an aperture area of 6,000 m<sup>2</sup> per installed MW of power capacity. A single storage unit has a capacity of six full load operating hours that will be used when applying additional collector fields for night storage. SM2 would require one 6-h storage unit and two × 6,000 m<sup>2</sup> solar field per MW. A CSP plant with a solar multiple 4 (SM4) would have 4 × 6,000 = 24,000 m<sup>2</sup> per MW solar field aperture area plus 3 × 6 = 18 h of storage capacity. Such a plant would achieve approximately 5,900 full load operating hours at 2,000 kWh per m<sup>2</sup> per year of annual solar irradiation in southern Spain (latitude 35°) and almost 8,000 full load hours (that is, full baseload) at a site in southern Egypt (latitude 25°) with 2,800 kWh per m<sup>2</sup> per year annual solar irradiation.

the parabolic shape of the trough is split into several smaller, relatively flat mirror segments. These mirrors are connected at different angles to a rod-bar that moves them simultaneously to track the sun. The absorber tube is fixed above the mirrors in the center of the solar field and does not have to be moved together with the mirror during sun-tracking. In the absorber tube, the concentrated sunlight converts water to superheated steam (up to 450°C), which drives a turbine to produce electricity.

3. *Central receiver (tower) systems* are large-scale power plants in which two-axis tracking mirrors, or heliostats, reflect direct solar radiation onto a receiver located at the top of a tower. The typical optical concentration factor ranges from 200 to 1,000. The solar energy is converted to thermal energy in the receiver and transferred to a heat transfer fluid (air, molten salt, water/steam), which is used to generate steam, which in turn, drives a conventional steam turbine to produce electricity.

Among the collector systems, the Linear Fresnel has several advantages (figure 5.5). Whereas parabolic troughs are fixed on central pylons that must be very sturdy and heavy to cope with the resulting central

**TABLE 5.3**

**Annual Full Load Hours of CSP Plant for Different Solar Multiple, Latitude, and Level of Annual Direct Normal Irradiance (DNI in kWh per m<sup>2</sup> per year) (h per year)**

	DNI 1800	DNI 2000	DNI 2200	DNI 2400	DNI 2600	DNI 2800
<b>SM1</b>						
Latitude 0°	1,613	1,869	2,128	2,362	2,594	2,835
Latitude 10°	1,607	1,859	2,130	2,344	2,581	2,808
Latitude 20°	1,559	1,801	2,082	2,269	2,502	2,725
Latitude 30°	1,460	1,689	1,977	2,128	2,350	2,580
Latitude 40°	1,310	1,524	1,815	1,920	2,127	2,366
<b>SM2</b>						
Latitude 0°	3,425	3,855	4,221	4,645	4,931	5,285
Latitude 10°	3,401	3,817	4,187	4,612	4,909	5,222
Latitude 20°	3,310	3,719	4,098	4,495	4,810	5,096
Latitude 30°	3,147	3,539	3,943	4,283	4,605	4,887
Latitude 40°	2,911	3,285	3,719	3,984	4,301	4,604
<b>SM3</b>						
Latitude 0°	4,869	5,414	5,810	6,405	6,713	7,147
Latitude 10°	4,829	5,358	5,752	6,365	6,690	7,074
Latitude 20°	4,711	5,223	5,630	6,229	6,583	6,929
Latitude 30°	4,499	4,995	5,434	5,970	6,352	6,676
Latitude 40°	4,189	4,674	5,163	5,601	5,987	6,322
<b>SM4</b>						
Latitude 0°	5,987	6,520	6,796	7,563	7,859	8,243
Latitude 10°	5,918	6,430	6,711	7,514	7,831	8,160
Latitude 20°	5,761	6,260	6,563	7,380	7,724	8,009
Latitude 30°	5,506	5,999	6,340	7,110	7,497	7,738
Latitude 40°	5,155	5,650	6,045	6,717	7,115	7,348

Source: Trieb and others 2009.

Note: SM1 = 6,000 m<sup>2</sup> per MW, no storage; SM2 = 12,000 m<sup>2</sup> per MW, 6-h storage; SM3 = 18,000 m<sup>2</sup> per MW, 12-h storage; SM4 = 24,000 m<sup>2</sup> per MW, 18-h storage.

forces, the Fresnel structure enables a very light design. Compared to the existing parabolic trough, some Linear Fresnel collector systems show a weight reduction per unit area of approximately 75 percent. This lightness not only lowers cost but also emits fewer pollutants during construction. However, a disadvantage is that the simple optical design of the Fresnel system leads to a lower optical efficiency of the collector field. Thirty-three to 38 percent more mirror area is required to get the same solar energy yield as with the parabolic trough.

Fresnel systems offer certain environmental advantages over linear parabolic troughs and towers. Less land is needed as the distance between mirrors is much smaller, enabling the collector area to cover 65–90 percent of the required land. In contrast, the parabolic trough mirrors cover only 33 percent of the land needed because considerable spacing is re-



**FIGURE 5.5****Linear Fresnel Collector, Plataforma Solar de Almeria, Spain**

Source: Fichtner and DLR 2011.

quired between the rows of mirrors to avoid mutual shading. Thus, land use efficiency of a Linear Fresnel can be approximately three times higher than that of a parabolic trough, resulting in twice the solar yield per square meter. This fact may not be of much importance in remote desert areas, in which flat, otherwise unused land is not scarce. However, optimal land use efficiency may be of importance when integrating CSP in industrial or tourist facilities, or placing CSP near the coast and close to urban centers.

An additional advantage is that the flat structure of the Fresnel segments can be integrated easily in industrial or agricultural uses. In the hot desert, the shade provided by the Fresnel segments could be a valuable extra service provided by the plant. The Fresnel segments could cover all types of buildings, stores, or parking lots; protect certain crops from excessive sunshine; and reduce water consumption by irrigation. However, the efficiency and capacity factor of Fresnel are lower than for the other technologies.

Central collector systems are the most delicate. They rely on curved reflective surface mirrors that have an independent solar-tracking mechanism that directs solar radiation toward the receiver. Heliostats must be cleaned regularly and, when wind speed is higher than 36 km per hour, they must be set vertically to avoid structural damage.

In principle, all CSP technologies can be used to generate electricity and heat. All are suited to be combined with membrane and thermal desalination systems. However, only central receiver systems can power all three alternative power generation systems (figure 5.6). Central receivers are the only option available to provide solar heat at high temperatures

FIGURE 5.6

### Linking the Choice of Solar Collection System to Power Generation and Desalination

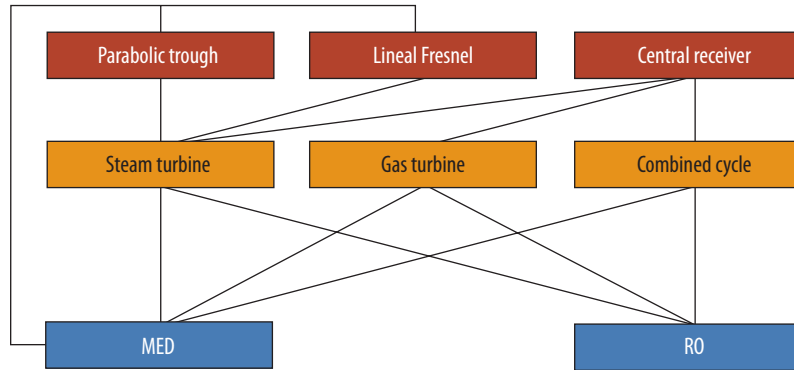

Source: Fichtner and DLR 2011.

up to 1,000°C. However, it is still uncertain whether the technical challenges of these systems will be solved satisfactorily and whether large-scale units will be commercially available in the medium term. Although their feasibility has been demonstrated, the early stage of development of central receiver systems still leaves open questions of cost, reliability, and scalability for production. Finally, neither parabolic troughs nor Linear Fresnel systems can power gas turbines.

The only proven, commercially available CSP plants today are linear concentrating parabolic trough systems. Up to now, they have had clear advantages due to lower cost, less material demand, simpler construction, and higher efficiency (table 5.4). Linear Fresnel systems are superior to the parabolic trough with respect to its use of synthetic oil as a heat transfer medium and its costs. On the other hand, Linear Fresnel systems have lower optical efficiency compared to the parabolic trough system. However, with additional experience and improvements in thermal energy storage, the Linear Fresnel technology likely will become highly competitive with—if not superior to—the parabolic trough.

### Typical CSP Desalination Plant Configurations

Following selection of solar collection arrays, four CSP desalination plant configurations were examined for this study to determine likely costs. The configurations differ mainly in the chosen desalination technology, power block cooling system, location of the CSP plant with respect to the desalination plant, and other boundary conditions such as seawater temperature and quality (figure 5.7):

1. Dual-purpose plant (MED-CSP and power plant) co-located at the coast with seawater cooling.
2. Stand-alone SWRO plant located at coast with CSP and power plant also located at coast with seawater cooling (once-through cooling).
3. Stand-alone SWRO plant located at coast but CSP and power plant located inland with air cooling. This configuration requires installa-

**TABLE 5.4****Comparison of Concentrating Solar Power Collecting Systems**

Technology	Parabolic trough system	Linear Fresnel system	Solar power tower
Application	Superheated steam for grid-connected power plants	Saturated and superheated steam for process heat and for grid-connected power plants	Saturated and superheated steam for grid-connected power plants
Capacity range (MW)	10–250	5–250	10–100
Realized max. capacity single unit (MW)	80	2 (30 under construction)	20
Capacity installed (MW)	920 (1,600 under construction)	7 (40 under construction)	38 (17 under construction)
Peak solar efficiency (%)	21	15	<20
Annual solar efficiency (%)	10–16 (18 projected)	8–12 (15 projected)	10–16 (25 projected)
Heat transfer fluid	Synthetic oil, water/steam demonstrated	Water/steam	Air, molten salt, water/steam
Temperature (°C)	350–415 (550 projected)	270–450 (550 projected)	250–565
Concentration ratio	50–90	35–170	600–1,000
Operation mode	Solar or hybrid	Solar or hybrid	Solar or hybrid
Land use factor	0.25–0.35	0.6–0.8	0.2–0.25
Land use (m <sup>2</sup> /MWh/year)	6–8	4–6	8–12
Estimated investment costs (€/kW)	3,500–6,500	2,500–4,500	4,000–6,000
Development status	Commercially proven	Recently commercial	Recently commercial
Storage options	Molten salt, concrete, phase change material	Concrete for preheating and superheating, phase change material for evaporation	Molten salt, concrete, ceramics, phase change material
Reliability	Long-term proven	Recently demonstrated	Recently demonstrated
Advantages	<ul style="list-style-type: none"> <li>• Long-term proven reliability and durability</li> <li>• Storage options for oil-cooled trough available</li> </ul>	<ul style="list-style-type: none"> <li>• Simple structure and easy field construction</li> <li>• Tolerance for slight slopes</li> <li>• Direct steam generation proven</li> </ul>	<ul style="list-style-type: none"> <li>• High temperature allows high efficiency of power cycle</li> <li>• Tolerates nonflat sites</li> <li>• Storage technologies are available, but still not proven in long term</li> </ul>
Disadvantages	<ul style="list-style-type: none"> <li>• Limited temperature of heat transfer fluid hampering efficiency and effectiveness</li> <li>• Complex structure, high precision required during field construction</li> <li>• Requires flat land area</li> </ul>	<ul style="list-style-type: none"> <li>• Storage for direct steam generation (phase change material) in very early stage</li> </ul>	<ul style="list-style-type: none"> <li>• High maintenance and equipment costs</li> </ul>

Source: Fichtner and DLR 2011.

Note: This comparison does not consider storage. If storage is considered, the central receiver applications with storage have the higher annual conversion efficiencies.

FIGURE 5.7

### Typical Configurations of CSP Desalination by the Type of Renewable Energy

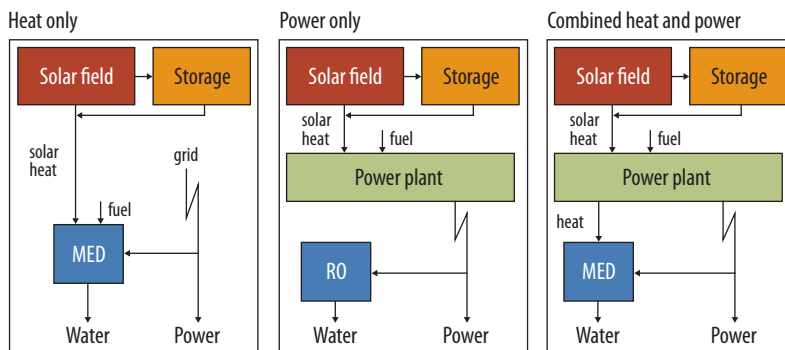

Source: Fichtner and DLR 2011.

tion of (availability of) power transmission line to supply power to RO plant at the coast.

4. “Solar only” power generation located inland, with SWRO stand-alone plant located at the coast with electricity supply from the existing local grid during periods when no solar irradiance is available. Under options “2” and “3” above, no local grid connection is assumed (that is, sufficient power is assumed to be generated by a hybrid CSP-conventional power plant on site).

CSP-MED plants must be located near the coast in proximity of the desalination plant because thermal power cannot be transported economically over longer distances. The potential advantage of RO is that its driving force is electricity, which can be produced elsewhere. In this case, the CSP plant can be located at inland sites (with dry-cooling option), where solar radiation typically is higher than at coastal sites, and electricity could be brought to the RO plant at the coast (which requires installation of a power transmission line). Alternatively, the RO plant could be co-located with the CSP at an inland site if inland disposal of brine can be safely managed. Figure 5.8 offers schematics of two CSP desalination configuration options. Figure 5.8a illustrates the option in which the CSP system is located inland to benefit from higher DNI at the inland location and the SWRO plant is located at the coast. Figure 5.8b offers a scenario in which both CSP and MED plants are co-located at the coast.

Given different plant components such as water and CSP solar-field and back-up power plant, different configuration possibilities exist to optimize power and water production. The focus can be set on the desalination plant to maximize the water production or on the power plant to

FIGURE 5.8

### CSP Desalination Plant Configurations

a. CSP-SWRO scheme with CSP plant located inland and SWRO located at coast

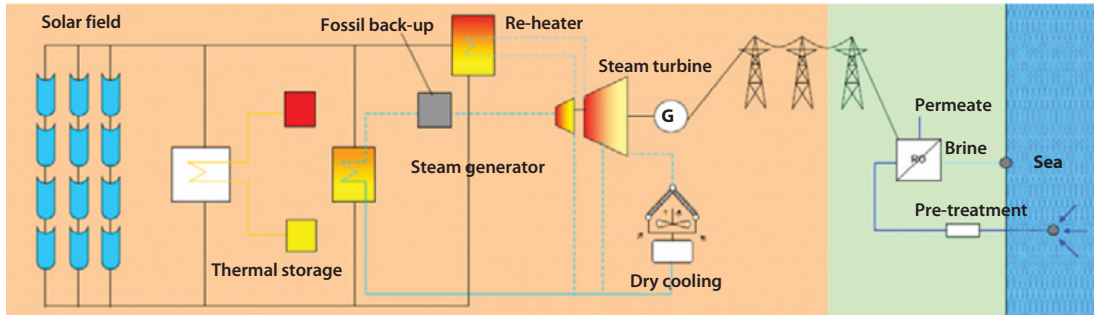

b. CSP-MED scheme with both CSP and MED plants co-located at coast

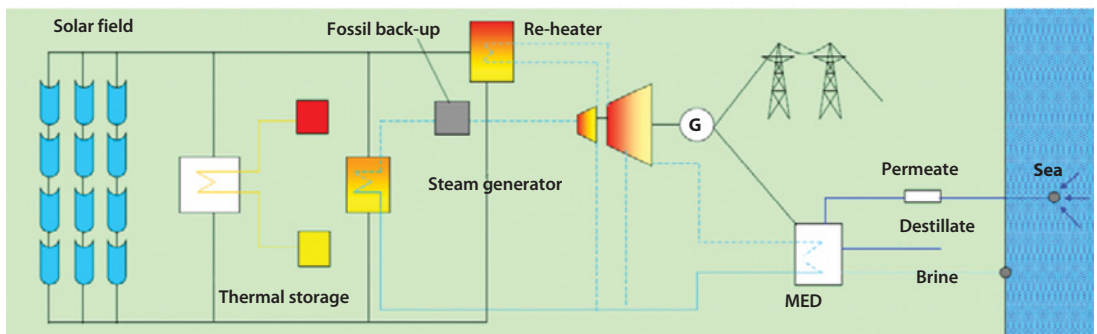

Source: Fichtner and DLR 2011.

maximize the electricity generation. The objective function, which sets out the main goals of the design, has great influence on the plant configuration selected for each plant. Since this volume is seeking solutions to meet the increasing water demand, the priority is given to optimization of water production.

### Costs of CSP Desalination

At present, pure CSP desalination is significantly more expensive than conventional energy desalination. This volume assumes a strategic approach to roll out CSP desalination in the MENA Region:

- Installed desalination capacities available up to year 2015 will be replaced over time with CSP desalination following the approach described in chapter 3 (figures 3.4 and 3.5).
- Additional desalination capacities needed after year 2015 using CSP desalination are planned.

- A hybrid CSP desalination option with an annual solar share of 46–54 percent is considered so that if solar operation is not possible (46–54 percent of the year), the plant will work as a conventional power plant.
- Two types of fossil fuels are considered: heavy fuel oil (HFO, with fuel factor of 80 percent) and natural gas (NG, with fuel factor of 85 percent).

The advantage in comparison to other RE sources is that the power plant (that is, the same turbine) can be used and a “shadow-power plant” is not necessarily required. The above assumptions are the basis for the CSP-based desalination cost estimation in this volume. Financial assumptions adopted in this volume to determine the capital expenditure (CAPEX) and operating expenditure (OPEX) of various CSP desalination configurations are described in table 5.5.

### Capital costs

The capital investment costs under CSP desalination consist of two major parts: the power source (including costs for solar field, thermal storage, and power block facility as well as back-up fuel) and the desalination component.

In this volume, for thermal desalination technology, “plain” MED using thermal energy directly from CSP plants is assumed. For membrane technology, electricity generated from CSP supplied via local/national grid is assumed. Three different plant configurations (options 2, 3, and 4 above) are considered for CSP-RO for cost analysis. Comparing options 1 and 2 (CSP/MD both located at the coast, and CSP/SWRO both lo-

**TABLE 5.5**

### Main Financial Assumptions for CSP-Desal CAPEX and OPEX Calculation

Category	Unit	Cost
Specific invest. for SF	\$/m <sup>2</sup>	420.0
Specific invest. for TES	\$/MWh <sub>th</sub>	77.0
Specific invest. for back-up boiler	\$/kW <sub>el</sub>	378.0
Specific invest. for fuel cost <sup>a</sup>	\$/MWh	64.9
Specific invest. for PB	\$/kW	1,540.0
Specific invest. for dry cooling	\$/kW <sub>el</sub>	434.0
Specific invest. for wet cooling	\$/kW <sub>el</sub>	150.0
Debt period	year	25.0
Discount rate	%	6.0
O&M rate for CSP + PB	%/year	2.0
Insurance rate	%/year	0.5

Source: Fichtner and DLR 2011.

Note: TES = thermal energy storage; SF = solar field.

a. Unsubsidized back-up fuel cost is considered based on opportunity cost of fossil fuel at international price and escalation of fuel cost by approximately 5 percent per year.

cated at the coast), solar field accounts for more than 50 percent of the total investment cost of the power supply. Thermal energy storage and power block each constitute approximately 20 percent of the CAPEX, while the back-up boiler is responsible for 4–5 percent of the investment (table 5.6). The CAPEX structure is very similar in both cases, with the exception of the cooling share. In the MED/CSP case (option 1), thermal desalination also serves as a condenser, so this share of the cost is given completely to the desalination. For the RO/CSP case (option 2), a condenser is needed, and it makes up for 2 percent of CAPEX. Dry cooling systems, which are not represented here, are more expensive than once-through systems.

Compared to conventional energy desalination, the investment cost of CSP desalination is significantly higher—by a factor of approximately four (tables 4.4 and 5.6). The large variation of capital cost for RO reflects the wide range of seawater salinity in MENA.

### **Operational costs**

Unlike initial capital investment costs, the operational costs of RE-desalination are significantly lower than conventional energy-based desalination. As described above, in this volume, it was assumed that the desalination facilities would operate in a hybrid mode because the solar share assumed in the study ranges from 46 to 54 percent.

### **Total water costs**

Combining the CAPEX and OPEX of CSP desalination plant configurations, this volume also calculated the levelized cost of water (LWC). The LWC has been grouped by the three macroregions of

**TABLE 5.6**

### **Capital Costs of Two Main CSP Desalination Configuration Options**

	MED-CSP	RO-CSP + dry cooling
Capital cost-desal (US\$/m <sup>3</sup> )	3,136	1,748–2,425
Capita cost (CSP + PB) (US\$/m <sup>3</sup> )	9,125	9,877–10,145
Total investment cost (US\$/m <sup>3</sup> )	12,261	11,625–12,570
<i>Breakdown of capital costs for CSP energy (%)</i>		
Solar field	57	54
Thermal storage	21	20
Power plant	18	19
Back-up boiler	4	5
Cooling	0	2

*Source:* Fichtner and DLR 2011.

*Note:* Costs are based on the design of a 100,000 m<sup>3</sup> per day desalination plant in a hybrid-CSP setup. Size of the thermal energy storage was twice the solar energy collection capacity assuming solar energy is available 46 percent of the year for MED and 54 percent for RO. MED = multiple effect distillation; CSP = concentrating solar power; RO = reverse osmosis; PB = power block.

MENA based on seawater temperature and quality (mainly salinity): Mediterranean, Gulf, and Red Sea (figure 5.9). Among the various desalination technologies studied, in general, the water costs are influenced primarily by capital costs for SWRO technology and by the energy costs for thermal desalination. In the case of MED, the steam costs have a major impact on the water price.

**FIGURE 5.9**

**Levelized Water Production Costs by Plant Type and Location**

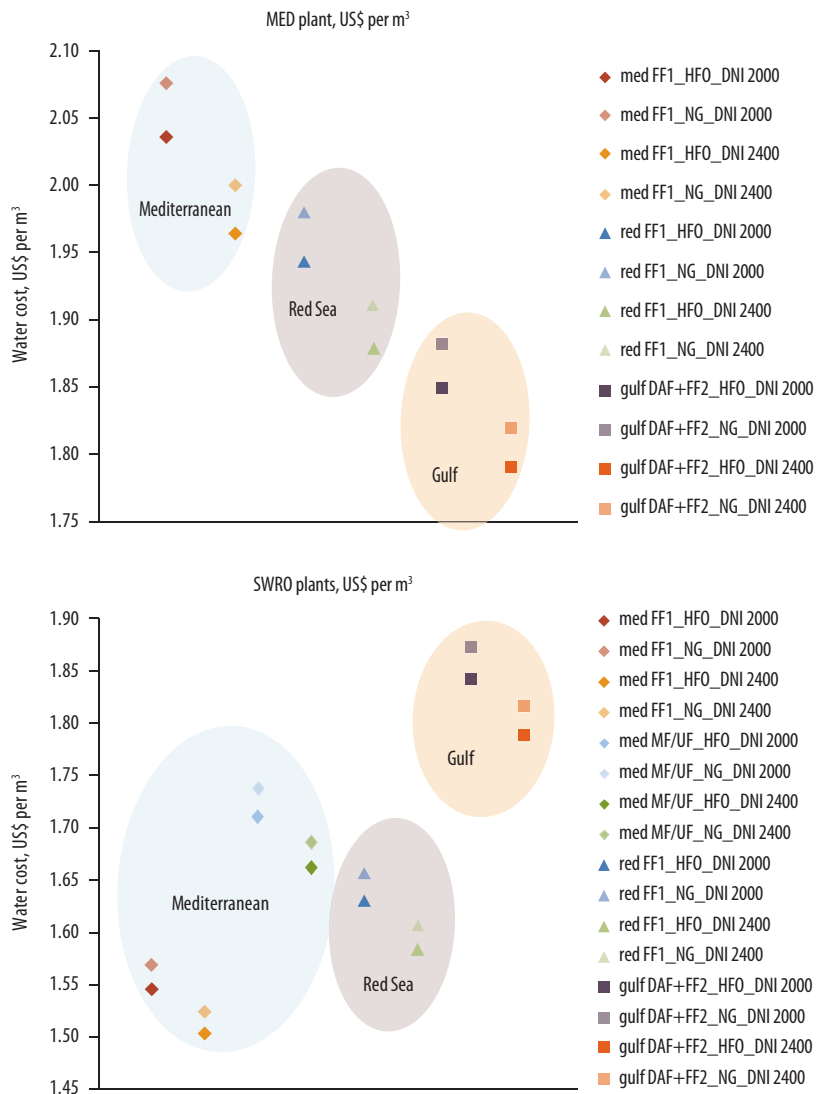

Source: Fichtner and DLR 2011.

Note: NG = natural gas; HFO = heavy fuel oil; MF/UF = micro/ultra-filtration; FF1/FF2 = single/double-stage floc-filtration; DAF = dissolved air flotation; "med," "red," and "gulf" stand for Mediterranean, Red Sea, and Gulf water, respectively.



Comparing CSP desalination technologies, MED is more expensive than RO except in the Gulf. The indicative water costs vary between US\$1.8 per m<sup>3</sup> and US\$2.1 per m<sup>3</sup>. RO provides the lowest cost water in the Mediterranean and Red Sea, from US\$1.52 per m<sup>3</sup> to 1.74 per m<sup>3</sup>. The pairs of symbols show the fuel option (NG or HFO) at the same solar DNI value for each macroregion. However, costs are similar to MED installed in the Gulf due primarily to the much higher salinity and temperatures, hence, higher pretreatment costs. RO costs also vary depending on coastal or inland locations. Inland, higher solar radiation (DNI of 2400) may reduce costs by as much as US\$0.15 per m<sup>3</sup> in the Mediterranean, but the difference elsewhere is negligible.

CSP-MED plant configurations could be preferable under special circumstances for specific projects. Key factors that may influence the selection of MED are:

- High seawater salinity and temperature
- High fluctuations in seawater quality
- Presence of algae bloom in seawater
- Availability of steam generated by power plant
- Availability of “waste heat” at the end of a process chain (for example, flue gas at high temperatures) in which the residual heat is not further used within the process so can be used by MED plant.

### **Innovation and Scaling-Up Will Reduce Costs**

Continued innovations will reduce the cost of MED and RO desalination (chapter 4). While desalination is a relatively small market for CSP, CSP can meet the large and growing national energy demand. In the face of rising costs for fossil fuel and its environmental implications due to GHG emissions, competition for this market likely will drive CSP innovation and scaling-up.

The solar collector field accounts for more than half the capital cost of CSP desalination systems. The collection efficiency is likely to increase significantly, particularly for linear Fresnel systems and solar power towers (table 5.6). Higher collection efficiencies will enable smaller solar collector areas for the same power generation and thus considerable cost savings. While the capacity of the power block is constant, the varying size of the solar collector field and storage will define the annual full load hours of the plant and thus its application to meet the needs of the three load segments: peak-, medium-, and baseload power. The ability to vary these sizes makes CSP a very flexible option for planning electrical gen-

eration capacity. These sizes thus are able to compete with the traditional electrical power sources that are operating in the specific load segment. While, currently, CSP cannot compete on price for all load segments, it will be competitive on peaking power production.

Thus, the strategy will be to phase in CSP in the different load segments that have different average costs of electricity generation. First, CSP power plants will be used to replace power plants in the peak load segment. Due to the high costs of peak load power, only a low amount of subsidies are necessary to make CSP competitive against conventional fossil-fired power plants. The electricity-generating costs of CSP will go down due to learning curve effects, and the electricity costs of conventional power plants will increase due to increasing fossil fuel prices. In this stepwise manner, CSP can be phased in to the medium and finally the baseload segment.

Figure 5.10 shows the applied strategy for a fictitious case country in MENA. Annualized costs of fossil fuel power generation are expected to increase in the future. By 2050 the cost of peaking power is projected to rise from its present US\$0.21 per kWh to more than US\$0.35 per kWh. Medium- and baseload power will be less expensive but will follow a similar trend. In contrast, present CSP costs of approximately US\$0.28 per

**FIGURE 5.10**

**Electricity Cost of Concentrating Solar Power Plants Compared to Specific Cost of Peak-, Medium-, and Baseload Plants (annualized costs)**

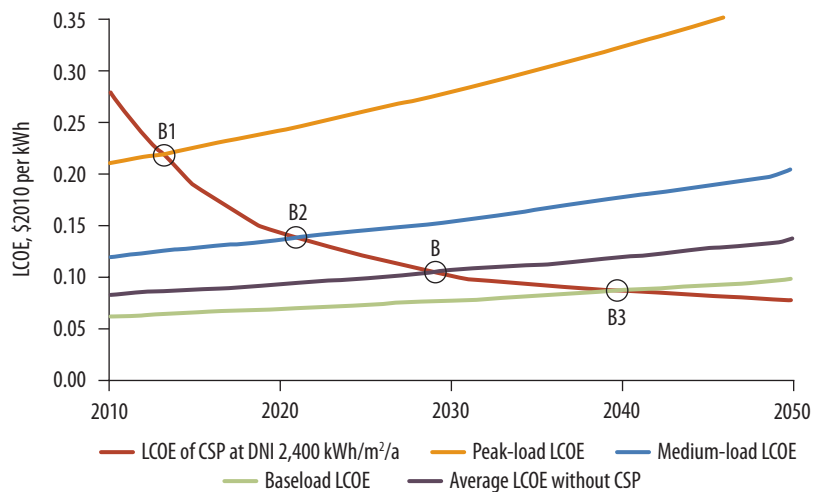

Source: Trieb and others 2011.

Note: LCOE (levelized cost of electricity) = LEC (levelized electricity cost); DNI = Direct normal irradiance; B = Break even with average electricity cost; B1 = Break even with peaking power; B2 = Break even with medium load; B3 = Break even with baseload.

kWh are expected to fall to approximately US\$0.08 per kWh by 2050. Starting a CSP project today could enable a first plant to be installed by 2013 (point B1) to supply peaking power. By that time, the plant already will be competitive with new conventional peaking plants fired with fuel oil. Plants installed in subsequent years in the same power segment will be even less expensive. By approximately 2020, CSP will start to be competitive with medium-load power plants (B2). If this process is continued by filling the medium-load segment with CSP and substituting more and more fuel in this sector, the break-even with the average electricity cost will be achieved before 2030 (point B). By 2040 CSP will break even in the baseload segment (B3).

The model case shows that the market introduction of CSP in MENA does not necessarily have to be based on subsidies. If fuel prices rise more, MENA countries immediately will save significant costs. If fuel prices go down, MENA countries will have even more financial resources to begin this important investment in a sustainable RE supply and to avoid future crises such as that of the summer of 2008. In the medium term, present net energy importers such as Jordan or Morocco could completely change their paradigms and become exporters of solar electricity.

In the model case, the conventional peak, medium, and baseload segments subsequently are replaced by CSP (figure 5.11). This is a very simple model of a national power park composed solely of conventional

**FIGURE 5.11**  
**Phased Market Introduction of CSP, 2010–50**

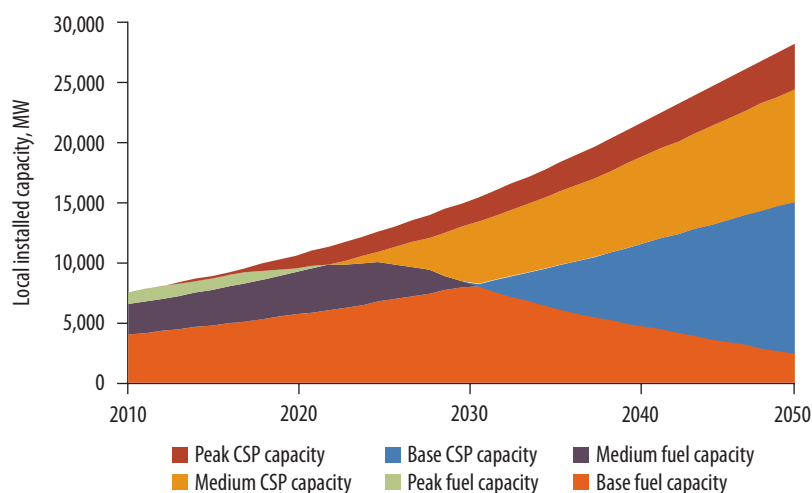

Source: Trieb and others 2011.

Note: Phased introduction begins with peaking, then medium, and finally baseload power production of the model case, subsequently first substituting expensive and later less expensive fuels in the power market. The expansion of CSP is consistent with replacing old plants and adding new energy.

and CSP plants. In reality, there will be additional capacity from other sources such as hydropower, wind energy, and photovoltaics. The structure, efficiency, and mix of the conventional fossil fuel-fired plants also will be different. Careful planning of added capacity and its function in the different power segments will be crucial.

### Future Outlook for CSP Desalination

The growing demand for fresh water is creating a large and rapidly growing market for desalination, and hence significantly large energy demand (chapter 4). The cost of CSP desalination likely will decrease in response to technical innovation, new materials, and efficiency improvements, just as desalination did when RO was first introduced. Demand and competition among suppliers will be the primary driving forces that cut costs. Desalination and energy professionals believe it will take another 15 years to develop the required critical mass to reduce costs. An important precondition is that international agencies and governments as well as the private sector promote renewable energy (such as CSP) for national power supply as part of the long-term strategy to increase energy security and to reduce greenhouse gas emissions. Notable research and development efforts are being supported by the European Union, Germany, Spain, and the United States. Similar initiatives are being undertaken by MENA governments including Algeria, Saudi Arabia, Morocco, Qatar, and the United Arab Emirates. This volume builds on these technological advances.

### Notes

1. 1 liter = 0.001 cubic meter.
2. In both tower and trough technology, the condensing temperature from the turbine exhaust depends on the ambient conditions. For the wet cooling tower, it is the wet bulb temperature; whereas for the air cooled condenser, it is the dry bulb temperature.
3. Since the wet cooling is used only a few hundred hours a year when the temperature is at a peak.
4. The *solar multiple* is the ratio of the actual size of a CSP plant's solar field compared to the field size needed to feed the turbine at design capacity when solar irradiance is at its maximum (approximately 1 kW per m<sup>2</sup>). Plants without storage have an optimal solar multiple of roughly 1.1–1.5 (up to 2.0 for Linear Fresnel reflector), depending primarily on the amount of sunlight the plant receives and the sun's variation throughout the day. Plants with large storage capacities may have solar multiples of up to 3–5.
5. There is a fourth class of collector, *dish-engine systems*, which focuses solar energy onto a central collector. A 10 m<sup>2</sup> dish mirror can generate 25 kW and

is best suited for small-scale applications (village level). Dish-engine systems are characterized by high efficiency, modularity, autonomous operation, and an inherent hybrid capability (to operate on either solar energy, or fossil fuel, or both). Among several solar technologies, dish-engine systems have demonstrated the highest solar-to-electric peak conversion efficiency (31.25 percent) (Sandia 2008) and therefore have significant potential for future development.

## References

- Fichtner and DLR. 2011. *MENA Regional Water Outlook, Part II, Desalination Using Renewable Energy, Task 1–Desalination Potential; Task 2–Energy Requirements; Task 3–Concentrate Management*. Final Report, commissioned by the World Bank, Fichtner and DLR. [www.worldbank.org/mna/watergap](http://www.worldbank.org/mna/watergap).
- PRODES (PRoMotion of Renewable Energy for Water Production through DESalination). 2010. “Global Renewable Energy Desalination by Energy Source,” ProDes, <http://www.prodes-project.org>. Accessed November 20, 2010.
- Sandia National Laboratories. 2008. *Stirling Energy Systems Set New World Record for Solar-to-Grid Conversion Efficiency*. Albuquerque, NM: Sandia National Laboratories. <https://share.sandia.gov/news/resources/releases/2008/solargrid.html>.
- Solar Millennium. 2011. “Parabolic Trough Power Plant with Thermal Storage,” Solar Millennium AG, [http://www.solarmillennium.de/includes/force\\_download.php?](http://www.solarmillennium.de/includes/force_download.php?) Accessed November 2011.
- Torresol Energy. 2011. “GemSolar Will Be the Main Project Presented by Torresol Energy in Solar Power International 2011.” Newspaper Library, September 26. <http://www.torresolenergy.com/TORRESOL/Press/gemasolar-will-be-the-main-project-presented-by-torresol-energy-in-solar-power-international-2011>.
- Trieb, F., and H. Müller-Steinhagen. 2008. “Concentrating Solar Power for Seawater Desalination in the Middle East and North Africa.” *Desalination* 220 (1–3): 165–83.
- Trieb, F., H. Müller-Steinhagen, and J. Kern. 2011. “Financing Concentrating Solar Power in the Middle East and North Africa: Subsidy or Investment?” *Energy Policy* 39: 307–17.



# Environmental Impacts of Desalination

Each desalination technology makes considerable demands on the environment. Given the large number of desalination capacities already installed and the expected growth in the future, the necessity of addressing these environmental issues becomes indispensable for MENA. This chapter provides an overview of the main environmental management issues related to desalination and makes general recommendations for the future.

Desalination has significant environmental impacts that affect both the atmosphere and the source waters. The high demand for heat and electrical energy from the process produces secondary atmospheric impacts in the form of CO<sub>2</sub> emissions. Whatever the power source, desalination generates concentrated brine that requires safe disposal. While thermal distillation produces three times more brine per unit of fresh water generated than reverse osmosis (RO), both types of desalination generally return the polluted water to the source sea. Furthermore, where RO is used inland to desalinate brackish water, the disposal of brine is a far more complex and expensive issue.

## Desalination: Atmospheric Pollution

Currently, the energy used in thermal and RO processes is provided from fossil fuels. Whatever the source of energy, be it electrical or thermal, substantial volumes of CO<sub>2</sub> and other gases are produced and emitted to the atmosphere. By 2050 MENA's incremental annual desalination requirements are projected to be approximately 90 km<sup>3</sup>. If this volume of desalinated water were produced by a 50:50 oil-gas mix using multiple effect distillation (MED)—effectively business as usual—CO<sub>2</sub> equivalent emissions would range from 270 to 360 million tons (MT) per year.<sup>1</sup> Under the optimized water supply scenario discussed in chapter 3, the

actual mix of desalination technology would be approximately 60 km<sup>3</sup> per year from CSP-MED and 30 km<sup>3</sup> per year from CSP-RO. Using this combination, CO<sub>2</sub> equivalent emissions would be 3.4–3.8 MT per year.<sup>2</sup> In sum, choosing RE would substantially benefit the environment by reducing GHG emissions.

## Desalination: Marine Pollution

The impacts of feed water abstraction and brine disposal on the marine ecosystem in the near-shore environment are potentially large. The main hazards are entrapment of marine life on the intake side and the effects of direct discharge of high-temperature, chemical-laden brine from desalination plants on marine organisms and environments. Although the Gulf of Arabia, the Red Sea, and the Mediterranean Sea effectively are closed basins, the likely impacts of brine disposal will vary considerably across the MENA Region because these seas differ notably (table 6.1).

The Gulf is a particularly sensitive environment as it is very shallow and has a slower rate of inversion and mixing with the Indian Ocean. The Gulf is home to over 700 species of fish, most of which are native to it. Of these 700 species, more than 80 percent are coral reef associated and directly or indirectly depend on the reefs for their survival. Mangroves provide important inshore habitats, particularly along parts of the southern shores. Sea-grass colonies are a vital habitat for much of the marine fauna (Al Jahani 2008). Different coastal and marine ecosystems are likely to vary in their sensitivities to concentrate discharge. Generally, salt marshes and mangroves in placid water marine environments have the highest sensitivity to brine disposal (Höpner and Windelberg 1996, 11–18). Additionally, the waters off Bahrain, Qatar, Saudi Arabia, and the United Arab Emirates have some 7,500 dugongs remaining, making the

**TABLE 6.1**

### Disposal of Incremental Volume of Brines from Desalination by 2050

	The Gulf	Red Sea	Mediterranean Sea	Other Seas <sup>a</sup>	Inland <sup>b</sup>	Total
Area (km <sup>2</sup> )	251,000	438,000	2,500,000	—	—	—
Mean depth (m)	50	490	1,500	—	—	—
Volume (km <sup>3</sup> )	12,550	214,620	3,750,000	—	—	—
Brine disposal (km <sup>3</sup> )	52	27	27	14	36	156

Source: World Bank 2004.

Note: — = not available.

a. Atlantic and Indian Oceans.

b. From RO plants discharging inland.



MAP 6.1

Desalination in the Gulf and Its Environmental Impacts, 2007

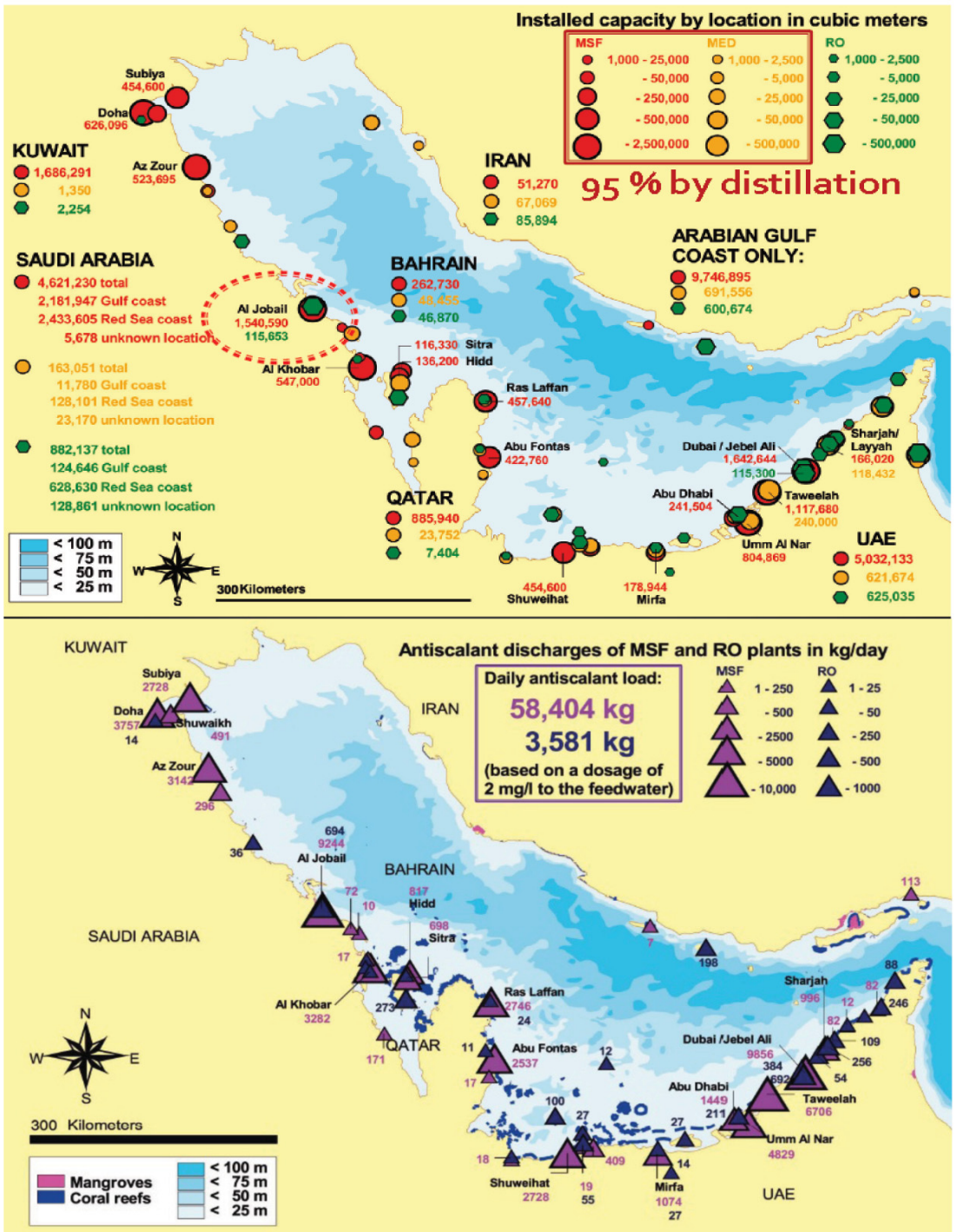

(Map continues next page)

MAP 6.1

Desalination in the Gulf and Its Environmental Impacts, 2007

(continued)

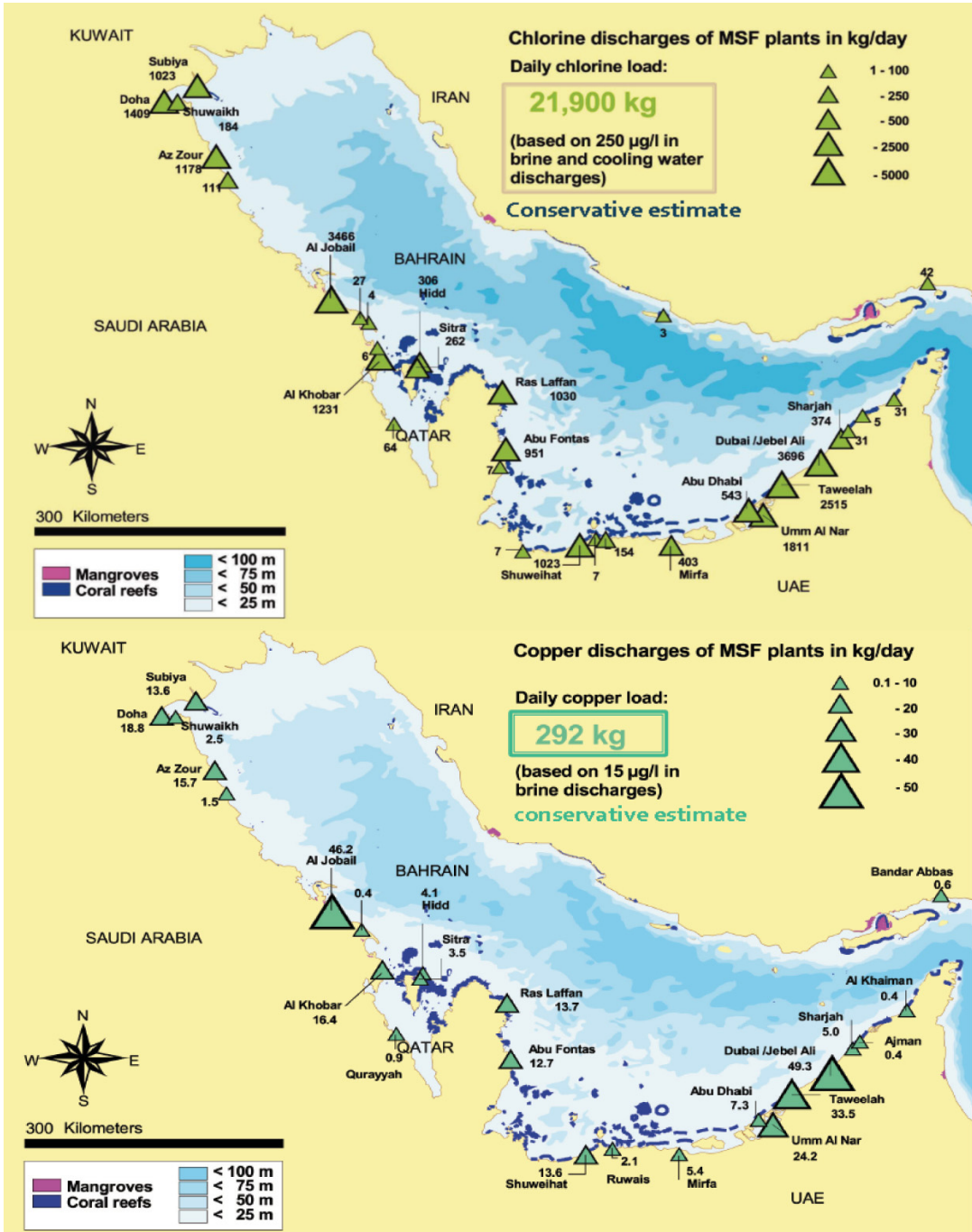

Sources: Quteishat 2009; distribution of desalination capacity based on Lattemann and Höpner 2003 and updated using 2006 International Desalination Association data.

Note: Map contains all plants >1,000 m³ per day capacity.

Gulf the second most important habitat for the species after Australia (Al Jahani, 2008).

Most of the brine disposal from desalination occurs along the western and southern shorelines of the Gulf and will affect the shallow near-shore environment (map 6.1). Volumetrically, brine disposal by 2050 is projected to be approximately equivalent to 2 percent to the volume of near-shore waters.<sup>3</sup> Major problems likely to be encountered are the Gulf's limited ability to absorb the high-temperature brine discharges and the effects that they and elevated salinity levels have on sensitive species.

The Red Sea is a more robust and substantially larger environment than the Gulf but has extensive shallow shelves noted for their marine life and corals. The sea is the habitat of over 1,000 invertebrate species and 200 soft and hard corals. This rich diversity is due in part to the ancient system of coral reefs formed largely of stony corals that extend 2,000 km along the coastline. The main reasons for the better development of reef systems along the Red Sea are its greater depths and efficient water circulation pattern. Although these features will reduce the impact of high-temperature brine discharge, great care will have to be taken when siting desalination plants to minimize environmental damage to coral reefs.

The Mediterranean Sea covers approximately 2.5 million km<sup>2</sup> and has a 46,000-km-long coastline. However, like the Red Sea and Gulf, it is effectively a closed basin connected to the Atlantic Ocean via the Strait of Gibraltar, which is only 14 km wide. In contrast to the Gulf and the Red Sea, the pollution hazards to the Mediterranean Sea are regulated. The 1976 Barcelona Convention "aims to reduce pollution in the Mediterranean Sea and protect and improve the marine environment in the area, thereby contributing to its sustainable development" (EU 1977).<sup>4</sup> Nevertheless, the Mediterranean is highly polluted. Because this sea has such a large volume of water, brine residues from desalination are expected to have only a modest impact on it. However, many marine species already have been almost wiped out due to the sea's pollution. In addition, as in the other seas, near-shore pollution from brine disposal is a likely hazard.

## Desalination-Brine Disposal Options

Different brine disposal options could be considered depending on the scope of desalination, sensitivity of receiving bodies, and cost of safe disposal. Generally, two major brine disposal options are available: (1) marine brine disposal and (2) inland brine disposal. These two are subdivided into additional options:

- *Surface water discharge including marine brine disposal.* Widely practiced method in most seawater desalinations.
- *Sewer disposal.* Done mainly for small-scale municipal desalination plants.
- *Deep well injection.* Practiced for brackish water desalination where the adverse impacts of such injections do not harm the quality of aquifers. A detailed hydrogeological study is a prerequisite to determine the safety of this practice.
- *Evaporation pond.* Usually applied for small-scale desalination plants and for brackish water desalination.
- *Zero liquid discharge.* Tends to be one of the most expensive. Usually practiced for industrial water desalination, or where desalination plant effluents are used as inputs for chemical industries such as salt production.
- *Land application.* Practiced for small-scale plants and where land is relatively inexpensive and readily available. User should be sure to mitigate any adverse environmental impacts.

### **Environmental Management of Marine Brine Disposal**

Brine disposal from desalination plants is recognized as an environmental hazard. Each stage of the desalination either adds or concentrates chemicals, most of which are discharged along with the brine at the end of the process (table 6.2).

Chemicals frequently are used to control marine growth, particularly mollusks around the intake structures supplying the desalination plant. Within the plant, seawater or brackish/saline groundwater again is subjected to chemical and mechanical treatment to remove suspended solids and control biological growth. During the application of energy to the treated seawater, brine is concentrated and returned to its source carrying all of the chemicals added during treatment. After treatment, the desalinated water is further treated with chemicals to prevent corrosion of the downstream infrastructure and water distribution network. In addition to the additives, the desalinated water is of a much higher density due to the large increase in total dissolved solids.

The salinity of the brine discharge from desalination plants may be more than twice the salinity of, and of a significantly higher temperature than, the sea water (table 6.2). Salinity of effluents from thermal desalination plants typically ranges from 46,000 to 80,000 parts per million. In addition the combined effects of higher temperatures, salinity, and chem-

TABLE 6.2

## Environmental Requirements for Desalination

	Desalination type	
	RO	MED and MSF
<i>Physical properties</i>		
Volume of saline water <sup>a</sup> per m <sup>3</sup> of fresh water	2.0–2.5 for seawater. 1.3–1.4 for brackish water.	4 for MED; 3 for MSF. —
Effluent salinity	Up to 65,000–85,000 mg/L.	Approximately 50,000 mg/L.
Temperature	Ambient seawater temperature.	+5–15°C above ambient.
Dissolved oxygen (DO)	If well intakes used, typically below ambient seawater DO. If open intakes used, approximately same as ambient seawater DO concentration.	Could be below ambient seawater salinity due to physical deaeration and use of oxygen scavengers.
<i>Biofouling control additives and by-products</i>		
Chlorine	If chlorine or other oxidants are used to control biofouling, to prevent membrane damage, they typically are neutralized before water enters membranes.	Approximately 10%–25% of source water feed dosage if not neutralized.
Halogenated organics	Typically, low content below harmful levels.	Varying composition and concentrations.
<i>Removal of suspended solids</i>		
Coagulants	May be present if source water is conditioned and filter backwash water not treated. May cause effluent coloration if not equalized prior to discharge.	Not present (no treatment required).
<i>Scale control additives</i>		
Antiscalants	Typically, below toxic levels.	Typically, below toxic levels.
<i>Foam control additives</i>		
Antifoaming agents	Not present.	Typically, below harmful levels.
<i>Contaminants due to corrosion</i>		
Heavy metals	Traces of iron, chromium, nickel, and molybdenum if low-quality materials are used.	Traces of copper and nickel concentrations if low-quality materials are used for heat exchangers.
<i>Cleaning chemicals</i>		
Cleaning chemicals	Alkaline or acidic solutions with additives, complexing agents, oxidants, and biocides.	Acidic (solution containing corrosion inhibitors).

Source: Modified from Lattemann and Höpner 2008, World Bank 2004.

Note: Comparisons are based on a plant capacity of 32,000 m<sup>3</sup>/day.

ical additives reduce the oxygen in the water and make it less soluble. Without proper dilution and aeration, a plume of elevated salinity and low oxygen discharge may extend over a significant area and may harm the near-shore ecosystem.

For example, in shallow coastal waters, RO reject streams, which have a higher density than seawater, will sink to the bottom and spread over the sea floor. This plume could affect benthic communities due to the high concentration of salt and residual chemicals. On the other hand, reject streams resulting from distillation plants, which typically are posi-

tively or neutrally buoyant, likely will affect pelagic species. However the mixing and dispersal of the discharge plume is dependent on the oceanographic conditions of the affected sites. Observations in the Gulf show that benthic communities in naturally saline environments, such as the Gulf of Salwa, which separates Qatar and Saudi Arabia, have experienced a decline in abundance of many coral species, mollusks, and echinoderms as a result of the long-term exposure to warm, saline effluents with low oxygen content (Lattemann and Höpner 2008).

Overall, copper and chlorine are the most serious environmental threats from seawater concentrate discharge. Chlorine is one of the major pollutants added to the feed water to prevent biofouling on heat exchange surfaces in MSF plants; it is little used in RO plants. Chlorine is a strong oxidant and a highly effective biocide. However, it also leads to oxidation byproducts such as halogenated organics and accumulates in sediments. Consequently, residual levels of chlorine from the effluent discharge may be toxic to marine life at the discharge site. The U.S. Environmental Protection Agency (EPA) places the chlorine exposure limit at 13.0 and 7.5 micrograms per liter for short- and long-term exposure, respectively. In Kuwait, concentrations of up to 100 micrograms—10 times the toxic levels for humans—were found 1 km from cogeneration plants outfalls (Lattemann and Höpner 2008). These levels are believed to pose high risks to some marine phytoplankton, invertebrates, and vertebrates. Halogenated compounds generally persist in the marine environment, and some are carcinogenic to animals.

As a plant's internal surfaces corrode, heavy metals enter the brine stream. Copper contamination is the major problem in MSF distillation plants but is almost absent in RO plants due to the use of nonmetallic materials and stainless steel. Nevertheless, RO brine generally contains trace levels of iron, nickel, chromium, and molybdenum. Heavy metals tend to enrich in suspended materials and sediments and affect soft bottom habitats such as those found in the Gulf. Many benthic invertebrates feed on this suspended or deposited material with the risk that the metals are enriched in their bodies and passed up the food chain (Lattemann 2010).

There is only modest information on the effect of brine discharge on the fauna of the MENA Region's seas. Spain experienced major impacts on seafloor communities from brine discharges that raised near-shore salinity to over 39,000 parts per million (ppm) (Ruso and others 2007, 492–503). Specifically, nematode (worm) prevalence increased from 68 to 96 percent in 2 years, while other species declined. Studies in Spain on sea grass habitats showed that even brief exposure—15 days—to salinities in excess of 40,000 ppm caused a 27 percent mortality of plants (Latorre 2005, 517–24). Generally, research indicates that the 38,000–40,000 ppm

zone represents a tolerance threshold for marine organisms (Jenkins and Graham 2006). Clearly, brine discharge from desalination plants has the potential to significantly impact near-shore ecology. Research results elsewhere have produced a range of findings. A comprehensive study of a thermal desalination plant in Key West, Florida, found that, over 18 months, the heated brine effluent, which was highly contaminated with dissolved copper, markedly reduced biotic diversity (Chesher 1975, 99–181).

The impact of brine and cooling water disposal on fisheries also is unknown. Over 350 commercial fish species and 14 shellfish species inhabit the continental shelves of the Arabian Sea, Gulf of Oman, and Arabian Gulf (Sideek and others 1999, 87–97). A comparison of one survey of the United Arab Emirates portion of the Gulf conducted by Food and Agriculture Organization of the United Nations (FAO) and another survey taken in 2003 found that stocks of bottom-feeding (demersal) fish had declined by 81 percent in 25 years (Bruce Shallard & Associates 2003). In contrast, the survey found that the stocks of surface-feeding (pelagic) fish remained approximately the same in 2003 as they had been in 1978. How much these impacts resulted from brine disposal is unknown so additional studies should be conducted to establish causality.

A consensus among many studies is that discharge site selection is the primary factor that determines the extent of ecological impacts of desalination plants (Lattemann and Höpner 2008; Manguin and Corsin 2005; Tsiourtis 2008). The hydraulic conditions at the discharge site should be able to dilute, disperse, and degrade the salt, heat input, and residual pollutants. The load and transport capacity of the site will depend primarily on water circulation and exchange rate as a function of currents, tides and surf, water depth, and bottom and shoreline morphology. In general, exposed rocky and sandy shorelines with strong currents and surf may be preferred over shallow, sheltered sites with little water exchange (Lattemann and Höpner 2008). In addition, semi-enclosed seas, such as the Gulf or the Red Sea, are perceived to be more susceptible to significant increases in salinity around outfalls due to the limited flushing (Purnama and others 2005; Roberts and others 2010).

### **Environmental Management of Inland Brine Disposal**

Given the region's significant brackish groundwater availability and the relatively lower cost of desalinating brackish water than seawater, a sizable amount of desalination is expected in the future by inland RO. Nevertheless, safe disposal of the brine will be a challenge. Inland brine disposal is both challenging and expensive (table 6.3). Unlike seawater desalination, inland RO and the resulting inland brine disposal carry a high potential

TABLE 6.3

**Challenges of Brine Disposal**

Disposal option	Capital cost <sup>a</sup>	O&M costs <sup>a</sup>	Land required	Env. impact	Energy	Public concerns	Geology
Surface water	L <sup>a</sup>	L <sup>a</sup>	—	M-H <sup>f</sup>	L <sup>b</sup>	H	—
Deep wells	M-H	M	L	L	M	L-M	H <sup>e</sup>
Evaporation ponds	H	L <sup>c</sup>	H	M <sup>d</sup>	L	H <sup>d</sup>	H
Land spreading	M	L	H	M-H	L <sup>b</sup>	H	H
Thermal evaporation	H	H	L <sup>d</sup>	L <sup>d</sup>	L <sup>g</sup>	L	L
Sewers	L <sup>a,b</sup>	L <sup>a,b</sup>	—	M <sup>d</sup>	L <sup>b</sup>	L	—

Source: Modified after NAS 2008, tables 4–5.

Note: Magnitude of challenge: L = low; M = medium; H = high; — = not available.

a. Costs are highly site-specific; general trends in relative costs are indicated; cost for surface water or sewer discharge can be higher if the distance from desalination facility to the discharge waterbody or sewer is large, necessitating long pipelines and/or pumping facilities.

b. Energy use for surface water or sewer discharge or land application possibly can be higher if the distance from desalination facility to the discharge waterbody, sewer, or land application site is large, possibly necessitating pumping facilities.

c. O&M costs for evaporation ponds could be higher if a significant number of well monitorings and associated water quality analyses are required.

d. Permitting complexity and environmental impacts of surface water, sewer disposal, and thermal evaporation could be higher if the feedwater-to-desalination process contains contaminants of concern that could be concentrated to toxic levels in the concentrated slurry or solids that are produced from this concentrate treatment process.

e. Requires good hydrogeological information to avoid contamination of fresh water aquifers.

f. Climate can indirectly influence surface water discharge by affecting the quantity of surface water available for dilution.

g. Generally, NAS rated “Energy” as “H.” However, because of the high solar radiation potential, in MENA, “Energy” is rated “L”.

hazard of polluting fresh surface water and groundwater. Inland brine disposal also may irreversibly damage soils and ecological systems.

The U.S. National Academy of Sciences considered a whole range of factors that should be taken into account when disposing of brine inland and ranked them in terms of the challenges they pose for management (table 6.3). Each of the disposal options has some management challenges. The surface water discharge option is the most practical, economical, and the most widely applied, concentrate disposal option for seawater desalination plants. The remaining alternatives have only limited applicability. They are considered to be viable only for smaller concentrate volumes from inland brackish water desalination plants.

Very few data exist on the costs of inland brine disposal. Most of the techniques are very costly compared to disposal to the sea, surface water, or sewers (table 6.4, figure 6.1). Figure 6.1 indicates only the relative costs of brine disposal.

Many of the factors considered in brine evaporation also are applicable to collection and evaporation of agricultural drainage, although the agricultural waters typically have far lower concentrations of total dissolved solids.



**TABLE 6.4**

**Cost Comparison of Brine Concentrate Disposal**

Concentrate disposal options	Cost (US\$/m <sup>3</sup> )	Critical factors
Surface water	0.03–0.30	Piping, pumping, outfall construction
Deep well injection	0.33–2.64	Tubing diameter and depth, injection rate, chemical costs
Evaporation pond	1.18–10.04	Pond size and depth, salt concentration, evaporation rate, disposal rate, pond liner cost

Source: Greenlee and others 2009.

Note: Costs include annualized capital and O&M.

**FIGURE 6.1**

**Scale-Dependent Capital Costs of Concentrate Disposal Options**

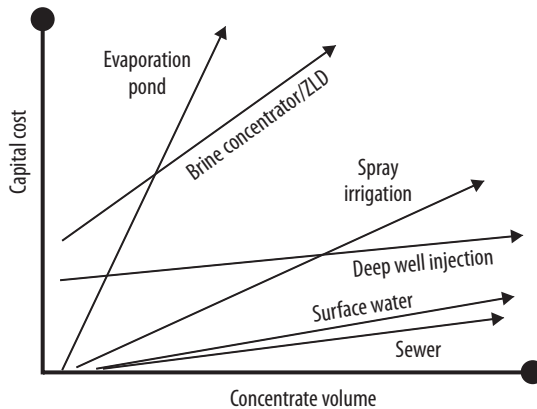

Sources: Mickley in Wilf 2007, 375–89; USBR 2003.

Note: ZLD = zero liquid discharge desalination.

**Evaporating ponds**

In California, over 1972–85, saline agricultural drainage (producing 400,000 tons of salt annually) was not allowed to be discharged to the San Joaquin River (San Joaquin Valley Drainage Implementation Program 1999). Instead, the water was directed to 28 evaporation ponds covering 2,900 ha. In addition to concentrating salts, these ponds provided seasonal resting, foraging, and nesting habitat for waterfowl and shore birds.

However, a 1979 environmental impact report (EIR) identified seepage, spillage from flooding, and accumulation of toxic or noxious wastes (pesticide, nutrients, and sewage) as damaging wildlife and the environment. As a result, many of these impacts were mitigated through better management and engineering measures.

**BOX 6.1****Cutting Environmental Management Costs:  
Brine Harvesting**

The Pyramid Salt Company of Northern Victoria, Australia, harvests salt evaporated from saline groundwater. The product is sold for stock feed and medical and chemical uses. Using a proprietary process, the company individually extracts specific dissolved minerals and compounds using multiple evaporations and/or cooling, supplemented by treatment with chemicals. Industries using these compounds include wallboard manufacturing, soil remediation and reclamation, and wastewater treatment. Enterprises typically are medium to large scale. Set-up costs are approximately US\$10,000 per ha. Good quality salts can be sold for US\$12 per t–150 per t.

*Source: Commonwealth of Australia 2002.*

Specific attention was paid to impacts on wildlife. It was found that selenium occurred at elevated levels (more than 0.2 ppm) in the concentrated water and that its bioaccumulation in the aquatic food chain reduced reproduction rates, caused birth defects, and killed water birds. The worst-affected ponds had their operating permits withdrawn by the Central Valley Regional Water Control Board (CVRWCB) until mitigation was successful. The CVRWCB entered into memoranda of understanding with three operators to carry out a follow-up EIR every three years. As a result, design and management practices of evaporation ponds were significantly improved.

***Brine may have commercial value***

Brine waste is an asset that may be used to offset the cost of desalination. In Australia, for example, brine water value-added enterprises are reducing costs and meeting environmental performance criteria (box 6.1).

**Necessity for Environmental Impact Assessment**

As a standard best practice, once the site has been identified, it is essential that a detailed environmental impact assessment (EIA) be conducted to identify and evaluate the effects on the environment of impact factors arising from proposed major new desalination plants and renewable energy plants. The purpose of an EIA is to determine the potential environ-

mental, social, and health effects of a proposed development. To avoid, minimize, remediate, or compensate for any adverse impacts resulting directly or indirectly from a project, the EIA studies project alternatives and identifies the potential adverse and beneficial environmental impacts of the project activities.

EIA legislation is not harmonized among the MENA countries. Hence there is room for discrepancy in the implementation of the recommended mitigation measures. A country's EIA should take into account international best practice. Moreover, as part of regional cooperation, it would be important for beneficiary/affected countries to move toward developing a common framework for implementing EIA procedures.

### **Regional Policy and Regulatory Frameworks Are Needed**

To redress the environmental negatives of desalination at intake sites and during disposal, comprehensive and consistent regional and national environmental laws are necessary to protect groundwater and shared waterbodies. Such laws are especially critical for shared waterbodies that already have large desalination plants installed or planned, such as the Gulf. Currently, more than 14 million m<sup>3</sup> of fresh water per day is produced from the Gulf. Countries along the Gulf are projected to expand their desalination capacity, tapping from the same water and disposing of the wastewater (brine) back to the same waterbody. The countries involved should take serious care to safeguard the health of a shared waterbody. Furthermore, for the measures to be effective, all countries that use water from, and/or discharge wastewater to, the shared seas should jointly plan and implement the necessary measures.

Some regional environmental regulatory frameworks already are in place. However, the enforcement mechanisms to implement the frameworks are lacking. The 1976 Barcelona Convention on the Mediterranean (EU 1977), the Kuwait Regional Convention for Cooperation on the Protection of the Marine Environment from Pollution (ROPME 1978), and the Jeddah Convention for the Conservation of the Red Sea and Gulf of Aden Environment are some of the existing regional environmental protection frameworks. It is critical that these agreed frameworks serve as a platform from which beneficiary countries can coordinate monitoring, planning, and implementing mitigation measures.

In addition, scientists from all countries involved should undertake joint studies and continuous monitoring. It is especially important for the countries to better understand the adverse impacts of brine surface water disposal on marine ecosystems and of inland disposal on groundwater aquifers. Reports from such studies should be published openly and used

for planning purposes as well. Countries also may pool their resources (for example, in the form of a multidonor trust fund) to finance continuous scientific studies and monitoring, and to finance preparation of projects that comply with agreed environmental standards.

A regional approach whereby countries agree to jointly develop desalination plants (or RE desalination plants) could generate multiple benefits to the countries involved. For example, countries that meet the favorable conditions for site selection can build future RE desalination plants and cover the water demand (and possibly the energy demand) of neighboring countries. While this approach might cause some geopolitical sensitivity, it would be an environmentally favorable solution. Such an approach also could make better economic sense by developing larger capacity plants that would benefit from economies of scale. Moreover, countries that have limited space for RE-based desalination could benefit from such joint regional planning and development of RE desalination by optimizing the locations of RE and desalination plants.

## Notes

1. Oil produces 700 tons of CO<sub>2</sub> equivalent for each GWh of energy produced; gas produces 450 tons.
2. CSP produces 17 tons of CO<sub>2</sub> equivalent for each GWh of energy produced.
3. Assuming a near-shore zone 5 km wide, 1,500 km long, and 20 m deep.
4. The Barcelona Convention of 1976, amended in 1995, and the Protocols drawn up in line with the convention aim to protect and improve the marine and coastal environment in the Mediterranean Sea, while promoting national plans to contribute to sustainable development. This convention has been updated six times to address specific hazards and reduce risks.

## References

- Al Jahani, A. A. 2008. *Dugong's Waning Populace in Arabian Gulf: A Chronicle*. Abu Dhabi, UAE: MoEW (Ministry of Environment and Water). [http://uaeagricent.moew.gov.ae/fisheries/Dugong\\_e.stm](http://uaeagricent.moew.gov.ae/fisheries/Dugong_e.stm).
- Bruce Shallard & Associates. 2003. *Fish Resource Assessment Survey Project of Abu Dhabi and UAE Waters*. Project Report presented to the Environmental Research and Wildlife Development Agency (ERWDA), Abu Dhabi.
- Chesher, R. H. 1975. "Biological Impact of a Large-Scale Desalination Plant at Key West, Florida." In *Tropical Marine Pollution*, ed. E. J. Ferguson Wood and R. E. Johannes, 99–150. New York: Elsevier.
- Commonwealth of Australia. 2002. *Summary Report: Introduction to Desalination Technologies in Australia*. Canberra: Department of Agriculture, Fisheries and Forestry. <http://www.environment.gov.au/water/publications/urban/pubs/desalination-summary.pdf>.

- EU (European Union). 1977. "Council Decision of 25 July 1977 Concluding the Convention for the Protection of the Mediterranean Sea against Pollution and the Protocol for the Prevention of the Pollution of the Mediterranean Sea by Dumping from Ships and Aircraft." Barcelona Convention, 77/585/EEC of September 19, 1977, O.J. No. L240.
- Greenlee, L. F., D. F. Lawler, B. D. Freeman, B. Marrot, and P. Moulin. 2009. "Reverse Osmosis Desalination: Water Sources, Technology, and Today's Challenges." *Water Research* 43: 2317–48.
- Höpner, T., and J. Windelberg. 1996. "Elements of Environmental Impact Studies on Coastal Desalination Plants." *Desalination* 108: 11–18.
- Jenkins, S. A., and J. B. Graham. 2006. "Oceanographic Considerations for Desalination Plants in Southern Californian Coastal Waters." Parts 1 and 2. Presentation given at meeting of National Research Council Committee on Advancing Desalination Technology, Irvine, CA. <http://escholarship.org/uc/item/9br897dx>.
- Latorre, M. 2005. "Environmental Impact of Brine Disposal on Posidonia Seagrasses." *Desalination* 182: 517–24.
- Lattemann, S. 2010. "Development of an Environmental Impact Assessment and Decision Support System for Seawater Desalination Plants." Ph.D. thesis. CRC Press/Balkema, 276 p. <http://repository.tudelft.nl/search/ir/?q=lattemann&faculty=&department=&type=&year>.
- Lattemann, S., and T. Höpner. 2008. "Impacts of Seawater Desalination Plants on the Marine Environment of the Gulf." In *Protecting the Gulf's Marine Ecosystems from Pollution*, ed. A. Abuzinada, H.-J. Barth, F. Krupp, B. Böer, and T. Abdelsalaam, 191–205. Basel: Birkhäuser Verlag.
- Mauguin, G., and P. Corsin. 2005. "Concentrate and Other Waste Disposals from SWRO Plants: Characterization and Reduction of Their Environmental Impact." *Desalination* 182: 355–64.
- Mickley, M. 2007. "RO Concentrate Management." In *The Guidebook to Membrane Desalination Technology, Reverse Osmosis, Nanofiltration and Hybrid Systems—Process, Design, Applications and Economics*, ed. M. Wilf. L'Aquila, Italy: Desalination Publications Balaban.
- NAS (National Academy of Sciences). 2008. *Desalination: A National Perspective*. Committee on Advancing Desalination Technology, Water Science and Technology Board, Division of Life and Earth Studies, National Research Council of the National Academies. Washington, DC: The National Academies Press, tables 4–5.
- Purnama, A., H. H. Al-Barwani, and S. Smith. 2005. "Calculating the Environmental Cost of Seawater Desalination in the Arabian Marginal Seas." *Desalination* 185: 79–86.
- Quteishat, K. 2009. "Environmental Effects of Desalination." Power point presentation at TechnoPark Environmental and Water Workshop, Dubai, November 7.
- Roberts, D. A., E.-L. Johnston, and N. A. Knott. 2010. "Impacts of Desalination Plant Discharges on the Marine Environment: A Critical Review of Published Studies." *Water Research* 44: 5117–28.
- ROPME (Regional Organization for the Protection of the Marine Environment). 1978. "Kuwait Regional Convention for Cooperation on the Protection of the

- Marine Environment from Pollution.” ROPME, Safat, Kuwait. <http://www.ropme.com/legal.html>.
- Sideek, M. S. M., M. M. Fouda, and G. V. Hermosa. 1999. “Demersal Fisheries of the Arabian Sea, the Gulf of Oman and the Arabian Gulf.” *Estuarine, Coastal and Shelf Science* 49: 87–97. Paper presented at the International Conference on the Biology of Coastal Environments, Bahrain, June 4.
- Tsitourtis, N. 2008. “Criteria and Procedure for Selecting a Site for a Desalination Plant.” *Desalination* 221 (1–3): 114–25.
- USBR (United States Bureau of Reclamation). 2003. *Desalination and Water Purification Technology Roadmap: A Report to Executive Committee*, discussion facilitated by Sandia National Laboratories and the U.S. Department of Interior, Bureau of Reclamation. Denver, CO. <http://www.dtic.mil/cgi-bin/GetTRDoc?Location=U2&doc=GetTRDoc.pdf&AD=ADA478619>.
- World Bank. 2004. *Seawater and Brackish Water Desalination in the Middle East, North Africa and Central Asia: A Review of Key Issues and Experiences in Six Countries*, final and main report, prepared by a consortium of consultants, consisting of DHV Water BV, Amersfoort, the Netherlands, and BRL Ingénierie, Nimes, France. [http://siteresources.worldbank.org/INTWSS/Resources/Desal\\_mainreport-Final2.pdf](http://siteresources.worldbank.org/INTWSS/Resources/Desal_mainreport-Final2.pdf).

## Concentrating Solar Power Desalination and Regional Energy Initiatives

The energy needs of the MENA Region are met almost exclusively by conventional fossil fuel supplies, most notably oil and gas. Few countries in the region operate their energy and electricity sectors on the basis of full cost recovery, although some of the nonfossil fuel exporters are beginning to increase prices toward covering costs.

The MENA Region is estimated to hold 57 percent of the world's proven oil reserves and 41 percent of the proven natural gas reserves. The region uses approximately 23 percent of its petroleum production internally. In contrast, the region's appetite for natural gas is increasing in response to the uptake of technology enabling its use. By 2020, natural gas is expected to comprise a larger share of the region's primary energy demand than petroleum.

As the region is water scarce by nature, it leads the world in reliance on desalination to provide its fresh water supplies. Desalination remains an energy-intensive activity. The water-scarce countries of the Gulf utilize as much as 23 percent of their primary energy for desalination. Achieving sustainability will require efficiency improvements in the performance of both the energy and water sectors of MENA countries.

New technologies are available, especially for solar energy (mainly concentrating solar power [CSP]), to ensure energy security for the region. However, these new technologies are more expensive and require systemic and strategic support to bring down their cost. Many MENA countries are rolling out ambitious renewable energy (RE) strategies in their energy portfolio mixes, but more are needed. Chapter 7 summarizes the associated challenges against adopting CSP desalination in MENA and the ongoing initiatives to make RE, more specifically CSP, affordable and accessible.

## Energy Consumption in MENA

Electricity generation in the MENA Region is estimated to have reached 1,146 Tera-watt hours (TWh), or approximately 3,000 kWh per capita in 2010 (table 7.1). In most MENA countries, more than 90 percent of their populations are connected to the electrical grid (IEA 2005). However, these high access rates are complemented by relatively high transmission system losses, ranging from slightly over 5 percent in Qatar to over 20 percent in Libya, the Syrian Arab Republic, and the Republic of Yemen. As a whole, the region's energy intensity remains roughly 1.5 times as high as in Organization for Economic Co-operation and Development (OECD)-Europe, reflecting MENA's generally lower economic efficiency of energy use (IEA and OECD 2005).

Most of the region's greenhouse gas (GHG) emissions are linked largely to the region's role as an energy producer. For 2008, the International Energy Agency (IEA) estimates total GHG emissions from fuel combustion in MENA was equal to 1,860 million metric tons (mt) of CO<sub>2</sub> equivalent. These emissions accounted for roughly 6.3 percent of the global emissions from fuel combustion. By 2010, the emissions from the region's power sector are estimated to have risen to 2,101 mt of CO<sub>2</sub> equivalent.

In energy terms, the region falls into two groups of countries. The first group is endowed with fossil fuel resources. These countries continue to face the challenge of how to use these resources to their best long-term economic advantage. Too often, the past approach has been to control domestic prices at unsustainably low levels, leading to significant ineffi-

**TABLE 7.1**

### Estimated MENA Electricity Generation, Installed Capacity and CO<sub>2</sub> Emissions, 2010

Electricity generation source	Estimated generation (TWh)	Estimated installed capacity (GW)	Estimated CO <sub>2</sub> emissions (MT)
Natural gas	781.6	236.0	1,291
Oil	259.8		668
Hydropower	28.3	12.6	2
Coal	46.0	9.7	135
Wind	12.1	5.3	0
Biomass	9.3	2.7	2
PV	5.8	3.6	3
Geothermal	2.3	0.3	0
CSP plants	0.4	0.2	0
Nuclear	0.0	0.0	0
<i>Total</i>	<i>1,146.0</i>	<i>271.0</i>	<i>2,101</i>

Source: Fichtner and DLR 2011.



ciencies in energy use. For the second group of countries—those who lack fossil fuel endowments—the challenge remains to maximize development while trying to judiciously manage fossil fuel importation and use. In these countries, energy subsidies are less striking, and cost-recovery from energy and electricity sectors tends to be better.

### **Drivers of Energy Demand**

The energy needs of the MENA Region will continue to grow as the population and economic development increase. The total energy demand for the region is projected to increase by 250 percent, from slightly more than 1,000 TWh per year in 2010 to over 2,500 TWh per year in 2050. This projection of energy demand for the region accounts not only for population and economic growth but also for an overall improvement in the efficiency of energy use.

Per capita electricity demand in the MENA countries demonstrates a vast range of differences. This range can be attributed to a number of factors usually cited, such as income and pricing policy, but also to the distinctions among the end uses. In four countries—Bahrain, Kuwait, Qatar, and the United Arab Emirates—per capita electricity consumption ranges from 10 to 17 MWh per capita per year—higher than the average OECD consumption of 9 MWh per capita per year. Israel's and Saudi Arabia's figures fall slightly below those of the OECD.

The use of air conditioning in the region is growing rapidly, partly because its efficiency is lower than in the rest of the world (IEA and OECD 2005). Air conditioning and conventional desalination are expected to drive MENA's electricity demand growth for the coming decades.

### **Water Use Also Consumes Considerable Energy**

Energy is required to move water from source to tap and to treat the inflows and outputs to acceptable environmental standards (figure 7.1).

Each component of the water supply and disposal cycle uses energy, and each step provides an opportunity to reduce energy consumption by economizing the use and increasing mechanical efficiency (Cohen and others 2004, box 7.1).

In the United States, due to ample water and a significant proportion of gravity water supply systems, water use consumes approximately 4 percent of national energy production. In Arizona, a public-awareness-raising campaign, "Saving Water Is Saving Money," asserts that for a city of 50,000 people, approximately 2 million kWh per year are required for all water-related operations, *with more than 1.6 million kWh per year needed for pumping alone* (Center for Sustainable Environments 2005). Where

FIGURE 7.1

### Stages of Energy Use in Water Supply, Distribution, and Use



Source: Cohen and others 2004.

#### BOX 7.1

### How Increased Energy Intensity Can Lead to Overall Energy Savings

Energy intensity measures the amount of energy used per unit of water. Some water sources are more energy intensive than others. For instance, seawater desalination requires more energy than wastewater recycling. Water conservation technology may either increase or decrease energy intensity.

Consequently, in making decisions, water planners should look not only at energy intensity but also at the total energy used from source to tap. Regarding water conservation, some programs may consume a great deal of energy at one stage in the energy-water cycle but decrease the overall energy use. The following three examples illustrate the interplay between energy intensity and total energy use.

1. Water conservation may increase energy intensity and increase total energy costs. A particular irrigation technology could reduce water use by 5 percent but require so much energy that overall energy increases by 10 percent. In this example,

total energy use would increase by 4.5 percent.

2. Water conservation may increase energy intensity and decrease energy use. The average high-efficiency dishwasher increases the energy intensity of dishwashing by 30 percent but reduces water use by 34 percent. As a result of using less water (and therefore less energy to supply the water from the source), the net total energy needed would decline by 14 percent.
3. Water conservation may decrease energy intensity and decrease total energy use. The average United States high-efficiency washing machine reduces water use by 29 percent compared with low-efficiency machines and lowers energy intensity by 27 percent. The energy intensity declines due to mechanical improvements, such as agitators. By reducing total water use and energy intensity, total energy use is reduced by 48 percent.

Source: Cohen and others 2004.

detailed inventories have been undertaken, in California, for example, water use accounted for 19 percent of the state's total energy consumption. A good portion of this amount was the result of pumping water 600 miles over the Tehachapi Mountains to supply Los Angeles.

After desalination and air conditioning, irrigation typically is the next largest user of energy in MENA.<sup>1</sup> Irrigated areas serving agriculture, forestry, and amenity plantations require energy to lift surface water and groundwater and to distribute it through modern mechanized irrigation systems. Reducing irrigated area, increasing the efficiency of irrigation water use, and reducing leachate requirements would lead to considerable energy savings.

Energy also could be reduced by better well-field location and design. Current MENA practices subsidize networks of wells that are not fine-tuned to the local hydrogeology. These wells also are spaced too closely to be hydraulically efficient. Given that almost all irrigation systems are mechanized, pumping at night would reduce evaporative water losses and, in turn, volumes pumped; plus use cheaper off-peak power. It also is cheaper to pump groundwater into a surface receiving tank than to use the well's pump to pressurize the irrigation system. Water then is pumped from the receiving tank using a far smaller pump for rotational irrigation.

Wastewater collection, treatment, and distribution comprise various activities that require energy and therefore have carbon footprints. The size of these footprints has become the subject of a number of investigations around the world. The results vary according to the treatment processing and distribution systems. In Abu Dhabi, for example, the annual consumption of electricity from processing wastewater in 2007 approximated 95,000 MWh. Using the estimated carbon emission of 380 g equivalent per Wh results in a carbon footprint of 36,100 tons per year.

As discussed above, despite large reserves of oil and natural gas in the region, domestic energy demand in MENA countries is growing fast. If trends continue, this demand cannot be sustainable. There is substantial RE (especially CSP) potential in MENA (chapter 4). However, challenges exist in terms of making CSP affordable and accessible. Similarly, technical, socioeconomic, and environmental challenges exist in combining RE with desalination (table 7.2).

## **Managing Barriers to Renewable Energy-Based Desalination**

### **Policy Challenges and Opportunities in MENA Countries**

To position themselves as technology and market leaders in the CSP industry, MENA countries are taking steps that demonstrate their commitment to reforms in the electricity sector, particularly in favoring greater

TABLE 7.2

**Barriers to RE Desalination in MENA**

Barrier	Effect
<p>Technological barrier</p> <ul style="list-style-type: none"> <li>• Components suitable for the smooth and efficient coupling of existing desalination with RE technologies are not easily available; most RE desalination technologies are not developed as a single system but as combinations of components developed independently</li> <li>• Desalination development focuses on ever larger systems</li> <li>• Most utility-scale desalination technologies require continuous operation, hence continuous energy supply; whereas most RE technologies provide intermittent power supply</li> </ul>	<ul style="list-style-type: none"> <li>• Poor reliability</li> <li>• Higher water cost</li> <li>• Lack of components for small-scale desalination, typical of many RE desalination combinations</li> <li>• Unfit technologies for direct linkage</li> <li>• Back-up fuel and/or energy storage is needed to supplement energy supply during nonoperational period, leading to additional cost</li> </ul>
<p>Economic barrier</p> <ul style="list-style-type: none"> <li>• Lack of comprehensive analysis of size, locations, and segments of market</li> <li>• Expensive; requires significant capital investment</li> <li>• MENA pricing structures and perverse water and energy subsidies create unfair competition</li> </ul>	<ul style="list-style-type: none"> <li>• Difficult to assess risks to investors; hence, investors hesitant to invest</li> <li>• Difficult to find financing</li> <li>• Investments in RE desalination remain unprofitable even in areas in which it offers better value than current conditions</li> </ul>
<p>Institutional barrier</p> <ul style="list-style-type: none"> <li>• In many MENA countries, energy and water are managed by two different ministries, leading to bureaucratic structures tailored to independent production of water and energy, and uncoordinated energy and water policies</li> <li>• RE desalination technologies require advanced skills and strong institutional capacity to operate</li> </ul>	<ul style="list-style-type: none"> <li>• Agreeing on solutions that optimize the benefit of both sectors is not always easy</li> <li>• Poor performance of the plants if adopted, but generally there is a tendency to avoid adoption of such advanced technologies that require skilled human resources</li> </ul>
<p>Environmental and social barriers</p> <ul style="list-style-type: none"> <li>• Desalination has negative environmental impacts (GHG emissions and brine disposal with chemicals that harm the environment)</li> </ul>	<ul style="list-style-type: none"> <li>• Communities reject desalination as an alternative water supply</li> <li>• Higher cost due to additional environmental mitigation requirements</li> </ul>

Source: Authors.

integration of renewable energies in their energy systems. These steps include, notably:

1. Gradually removing subsidies on fossil fuels to provide price signals to consumers. These signals will encourage energy efficiency on the demand side and create a level playing field on the generation side to make their RE technologies competitive.
2. Limiting electricity demand growth through demand-side management (DSM) and other measures. Demand is growing at 6–9 percent per year in most MENA countries, partly due to inefficient use of electricity. Given that CSP and other RE technologies have high capital costs, capacity additions are to be undertaken in an optimal manner that duly considers the rational use of energy to limit demand growth.

3. Creating a transitional incentive scheme until cost reduction in CSP is achieved, exports are possible, and fossil fuel subsidies are removed.

Several of the MENA countries are taking key steps to promote RE as discussed below. A more complete list of initiatives taken by MENA countries is included in appendix D.

### **Algeria**

Algeria heavily subsidizes energy prices. The country thus functions as a key driver of inefficient energy use and the resulting high energy intensity. In view of the rising energy intensity, the government has emphasized energy efficiency and RE options while considering energy pricing issues as appropriate and creating funding mechanisms. The resources for the funding include taxes on natural gas and electricity, and an initial government contribution. Additional resources may include taxes on energy-intensive equipment, penalties, loan reimbursements, and government or other contributions.

The government also has taken steps to support renewables, CSP in particular. Under a 2004 decree, premiums are granted for electricity produced from RE resources. For hybrid solar-gas power plants (when solar accounts for at least 25 percent of the plant's production), the decree states that the premium will be 200 percent of the average system price. For pure solar plants, the premium will be 300 percent of the average system price. The actual premium level will be updated based on data from the plants that become operational.

### **Egypt**

The prices for energy products in Egypt generally are below economic cost. The resulting implicit subsidies to the economy are quite large: 2009 energy subsidies came to US\$11 billion. To bring sector finances and energy consumption onto a more sustainable path and to reduce the fiscal burden of energy consumption, in 2004 the government initiated a series of energy price increases. Due to the political uncertainties, the future pace of these adjustments remains uncertain. In addition to the steps on reforms, the government is facilitating RE development through specific policy interventions. In March 2010, the Supreme Energy Council approved key policy steps related to scaling up wind and CSP. These steps were proposed under the new electricity law but have yet to be submitted to Parliament. They include:

- Approval of the necessity to cover additional costs for RE projects through tariffs
- Approval of zero customs duty on wind and CSP equipment

- Finalization of the land use policy for wind and CSP developers
- Acceptance of foreign-currency-denominated power purchase agreements (PPAs) and confirmation of central bank guarantees for all build-own-operate (BOO) projects
- Permitting support to developers with respect to environmental, social, and defense permits.

### ***Jordan***

Jordan is one of the first countries in the region to initiate fundamental reforms in the electricity sector. The country has made significant progress in carrying out these reforms including phasing out subsidies and introducing the private sector. Although electricity tariffs are largely cost reflective, some cross-subsidies remain embedded in the tariff structure. After the relevant studies are completed to ensure end-user tariffs are appropriately cost reflective, the regulatory commission plans to integrate an automatic fuel price adjustment mechanism to tariff calculations.

In addition to these reforms, which will help level the playing field for competing energy technologies, the government is taking steps to create a favorable policy environment for renewables. In February 2010, a Renewable Energy and Energy Efficiency Law (REEE Law) was ratified. The law established a Jordan Renewable Energy and Energy Efficiency Fund (Jordan REEF), which will help mobilize financial and technical support for RE and energy efficiency efforts, including from the government's budgetary contribution. Among others, the REEE Law commits to introduce a minimum of 500 MW of RE-generated power and a registry of land available for use based on resources maps and measurements, the purchase of all renewable power, and interconnection benefits. Moreover, the government of Jordan has granted an import tax exemption for RE equipment. Currently, the government is preparing a RE transaction strategy expected to be approved by the cabinet by the end of the year.

### ***Saudi Arabia***

Saudi Arabia is well endowed with primary energy resources. It has the largest proven oil reserves in the world as well as significant gas resources. Saudi Arabia exports approximately 2.7 billion barrels of oil per year (EIA 2011). In the past few decades, due to increasing population and growing economy, Saudi Arabia's domestic consumption of electricity has been on the rise. In the next 20 years, Saudi Arabia's electricity demand is projected to triple. If energy efficiency is not improved and current trends continue, domestic fossil-based fuel demand in Saudi Arabia is expected to reach over 8 million bbl/day (oil equivalent) by 2030. This rate is not

sustainable and, if current trends continue, will jeopardize Saudi Arabia's oil export revenues.

It is this growing recognition of the ever increasing domestic energy demand and equivalent loss in revenue stream (and the huge potential for solar energy in Saudi Arabia) that led the government of Saudi Arabia to recognize the importance of increasing RE's share in its energy portfolio mix. As a result, the government established the King Abdullah City for Atomic and Renewable Energy (KA-CARE) to lead RE development in the country, and position Saudi Arabia as an energy exporter, not solely an oil exporter, over the medium and long terms.

KA-CARE is looking into exploring and developing Saudi Arabia's solar, wind, and geothermal resources. Saudi Arabia also is investing significantly to develop the technology and human capacity required to build an important new economic sector focused on alternative energy. This sector will create new business and job opportunities for Saudi Arabia's citizens, which will help diversify the economy, improve quality of life, and make Saudi Arabia a world leader in alternative energy.

Similarly, Saudi Arabia is actively developing RE desalination as an alternative to conventional energy desalination, which consumes an increasingly significant portion of the nation's domestic oil production. For example, the King Abdulaziz City for Science and Technology (KACST) is building the world's largest solar-powered desalination plant in the city of Al-Khafji to produce 30,000 m<sup>3</sup> of desalinated water per day (under phase-1) to meet the needs of 100,000 people. The plant will use a concentrated solar photovoltaic (PV) technology and new water-filtration technology, which KACST has been developing in collaboration with IBM. The plant is expected to be operational by end of 2012. Saudi Arabia plans to expand the concentrated PV-based desalination fivefold under phase-2. Saudi Arabia also recently announced a plan to generate 54 gigawatt (GW) of electricity from renewables by 2032—about 41 GW is from solar alone (of which 25 GW is from CSP and the remaining 14 GW is from PV).

Regarding energy policy, Saudi Arabia is looking at providing incentives to encourage investment in RE through feed-in-tariffs and central procurement approach.

### **Morocco**

Both petroleum products and electricity are sold to consumers at below the cost of supply through a compensation system. In the case of petroleum products, the system is administered by the state. In the case of electricity, state support goes to the national electricity company, ONE (*Office National de l'Electricité*). To lessen the burden on state finances, a reform

of the energy price system is becoming imperative, especially because the government has committed to finance solar energy from 2009 onwards.

On November 2, 2009, HM King Mohammed VI announced a landmark US\$9 billion Solar Plan. The plan intends to install 2,000 MW of solar power generation capacity by 2020. Installation will begin with the ambitious Ouarzazate 500 MW CSP project, which recently was approved based on a public-private business model. In addition to fostering low-carbon development of the energy sector and enhancing energy security, the implementation of this plan will stimulate large investments and enhance Morocco's competitiveness. The legal, regulatory, and institutional framework is being set up with several laws enacted in early 2010, including the RE law, the law creating the Solar Agency to implement the Solar Plan, and the law setting up the Energy Efficiency Agency.

### **Tunisia**

Tunisia subsidizes electricity prices as there is a significant gap between *Société Tunisienne de l'Électricité et du Gaz* (STEG's) average selling price and the company's supply cost (20–30 percent in the last four years). The company receives a subsidy to make up the difference. In addition, power prices are indirectly subsidized through low gas transfer prices. Petroleum product prices are indexed with caps and floors to limit the extent of price fluctuations.

A rational use of energy always has been a priority in Tunisia. A presidential program covering 2010–14 recently reinforced the objectives. Its targets for 2014 are a 10 percent reduction in energy intensity, the addition of 430 MW of renewable power generation capacity (a fivefold increase in installed capacity), and complete elimination of fluorescent lamps.

The Tunisian Solar Plan (TSP), launched in December 2009 for 2010–16, aims to increase the share of RE and energy efficiency. Forty projects have been identified (in solar, wind, and biomass), for a total investment amount of € 2 billion, 1.4 billion of which is to be provided by the private sector. Over 2010–30, Tunisia expects to save 10 Mtoe of fossil fuels through its energy conservation efforts: 80 percent from energy efficiency and 20 percent from RE. Interconnection with Europe to facilitate exports is a key element of the TSP, as is the development of a local equipment industry to contribute to economic growth and job creation.

### **The United Arab Emirates (Masdar Initiative)**

Abu Dhabi has embarked on a two-decade program to transform its economy from one based on natural resources to one based on knowledge, innovation, and the export of cutting-edge technologies. Guiding this transformation is the Abu Dhabi Economic Vision 2030, which provides



a comprehensive plan, including the steps to be taken to transform the emirate's economy over the next two decades.

Key goals include increasing the non-oil share of the economy from approximately 40 percent to more than 60 percent and significantly diversifying the scope of economic activity. The initiative also strongly emphasizes value-added knowledge-based industries, such as RE and sustainable technologies.

Established in 2006, Masdar is a commercially driven enterprise that aims to cover the broad boundaries of the RE and sustainable technologies industry. Masdar operates through five integrated units, including an independent, research-driven graduate university (the Masdar Institute). The initiative seeks to become a leader in making RE a viable business and Abu Dhabi a global center of excellence in the RE and clean technology category. Its project, the zero-carbon, zero-waste Masdar City, has won numerous international awards for sustainable living.

Masdar will contribute significantly to this diversification in a number of ways. Across its five integrated units, the company will help to:

- Expand the export base
- Encourage private-sector entrepreneurship
- Invest in education and research that stimulates innovation
- Train, attract, and retain skilled workers in knowledge-based sectors
- Encourage investment in areas that generate intellectual property gains
- Grow the non-oil sector's share of the emirate's economy and decouple economic growth from fluctuating oil prices.

## **Regional Initiatives to Promote RE**

### ***MENA CSP Investment Plan***

To keep pace with demand, installed electricity-generating capacity in the region will almost double by 2050. In addition, most existing installed capacity will need to be replaced. The future market for new electricity-generating capacity is both large and assured. These circumstances represent an ideal opportunity to reduce the region's dependence on fossil fuels and to introduce RE alternatives, including CSP.

The MENA CSP investment plan aims to accelerate CSP expansion through a 1.0 GW program comprising 11 commercial-scale power plants and two regional transmission projects: the Tunisia-Italy transmission project and the Mashreq CSP transmission project. These projects will contribute to Mediterranean grid enhancement and exports. The

initiative aims at mobilizing US\$5.6 billion to accelerate deployment of CSP projects in Algeria, Egypt, Jordan, Morocco, and Tunisia. The initiative already has been awarded US\$750 million from the Clean Technology Fund (CTF)—part of the World-Bank-managed Climate Investment Funds—in recognition of the initiative’s important role in promoting clean energy and low carbon growth in developing countries.

The MENA Region is the least expensive place globally to reduce costs for CSP through manufacturing economies of scale. These result from the physical attributes of the region combined with potential access to the high-paying European Union (EU) green electricity markets enhanced by the Union for the Mediterranean and the eligibility for financing under international climate change instruments. Since the launch of the Union for the Mediterranean in 2008, the two following premises that underpin the Mediterranean Solar Plan have been widely discussed and recognized:

1. Europe can meet its decarbonization objectives more efficiently by tapping resources in neighboring countries, particularly the southern Mediterranean countries.
2. Exports are essential to scale up RE in the MENA Region, and such exports would be mutually beneficial.

In view of the economic development impacts and cost reduction possibilities, MENA countries also are especially keen to increase local manufacturing capacity for CSP. A preliminary assessment shows that the potential of MENA countries to manufacture components of the CSP plants is high. All construction works at the plant site, including the basic infrastructure works, installation of the solar field, and construction of the power blocks and storage systems, could be undertaken by local companies. Thus, local work could account for roughly 17 percent of the total CSP investment. Similarly, the mounting structure could be supplied locally if local companies could adapt manufacturing processes to produce steel or aluminum components with the required accuracy. For the more complex components, local industry development would depend largely on the anticipated growth in the size of the regional and global solar electricity markets. Such components would require joint ventures (JVs) or foreign direct investment (FDI) to install new production facilities in MENA. The current investment scale-up of 1.0 GW offers multiple opportunities to be explored.

Already in Egypt, the solar field of the 20 MW Kureymat project was tendered to a local company, Orascom Construction. The company’s bid was based on its capability to manufacture locally the frame of the solar parabolic trough in its subsidiary company, National Steel Manufactur-

ing (NSM). Orascom had to subcontract for both the mirrors and the tubes; nevertheless, the company has gained huge experience in assembling and testing both components. Orascom also implemented the civil and electrical works. The local component represented 50 percent of the total solar field work.

### ***DESERTEC Initiative***

DESERTEC is a global civil society initiative that began in 2003 and grew out of a network of scientists, politicians, and economists from around the Mediterranean. Together, they developed a DESERTEC Concept and Foundation, intended to shape a sustainable energy and water supply for MENA and EU countries.<sup>2</sup> The concept demonstrates a way to provide climate protection, energy security, and development by generating sustainable power from the sites in which RE sources are the most abundant. The energy produced in MENA from those sites will be transported to Europe via high-voltage direct current (HVDC). In contrast to conventional alternating current (AC) transmission, HVDC can carry electricity generated from renewables over long distances with losses of only 3 percent per 1,000 km.

Since 90 percent of the world's population lives within 3,000 km of deserts, the DESERTEC concept can be scaled up beyond EU-MENA to the Americas, Australia, the whole of East Asia, India, and Sub-Saharan Africa wherever suitable deserts are within reach of demand centers.

## **Notes**

1. For example, according to Dr. Hafez Salmawy, head of the Egyptian Electricity Regulatory Authority, the energy consumption of underground water pumping has grown to consume approximately 28 percent of the electricity provided by the El Beheira Electricity Distribution Company, a company responsible for electricity distribution for most of northwestern Egypt. Interview by Klawitter and others, November 8, 2010, in Klawitter and others 2011.
2. <http://www.desertec.org/concept/>

## **References**

- Center for Sustainable Environments. 2005. *The Interrelations of Water and Energy: Water and Energy Fact Sheet*. Flagstaff, AZ: Northern Arizona University.
- Cohen, R., B. Nelsen, and G. Wolff. 2004. *Energy down the Drain: The Hidden Costs of California's Water Supply*. Oakland, CA: NRDC (National Resources

- Defense Council), Pacific Institute. <http://www.nrdc.org/water/conservation/edrain/edrain.pdf>.
- EIA (US Energy Information Administration). 2011. *Annual Energy Outlook 2011*. Washington, DC: EIA.
- Fichtner and DLR. 2011. *MENA Regional Water Outlook, Part II, Desalination Using Renewable Energy, Task 1–Desalination Potential; Task 2–Energy Requirements; Task 3–Concentrate Management*. Final Report, commissioned by the World Bank, Fichtner and DLR. [www.worldbank.org/mna/watergap](http://www.worldbank.org/mna/watergap).
- IEA (International Energy Agency) and OECD (Organisation for Economic Co-operation and Development). 2005. *World Energy Outlook 2005, Middle East and North Africa Insights*. Paris: IEA and OECD. <http://www.iea.org/weo/docs/weo2005/WEO2005.pdf>.

# Conclusions

## MENA's Water Scarcity Is Bound to Grow

The current MENA water shortage will increase fivefold by 2050. The ever-growing water gap in the MENA Region has two solutions: *better demand management* and *new sources of water*.

### 1. Demand Management Must Be First Priority

- Toward 2050, managing demand, particularly of agricultural water use, is the key to reduce the high costs of closing the MENA Region's water gap. Not only does current demand exceed renewable supplies but also global warming likely will reduce water supplies below even current levels. Failure to save water and reduce uneconomic agricultural use will have severe socioeconomic repercussions because once renewable water resources are used up, the only effective source of new water will be desalination of seawater and brackish groundwater.
- Implementing demand management and increasing water supplies to fill MENA's 2050 water gap of almost 200 km<sup>3</sup> will be daunting and expensive. The most important finding is that managing agricultural water demand, even if more difficult to plan and predict, could provide as much water as new desalination.

### 2. Supply Management Options Are Limited

- Given that rivers in MENA are the most dammed in the world and given the likely negative impacts of global warming on the region's water availability, additional reservoirs to increase water supply have very limited potential. Wastewater reuse and desalination hold the most potential to add new water to the system.

## MENA Increasingly Will Rely on Desalination

- Desalination has proved to be a technically feasible supply solution to MENA's water gap and will continue to be so.
- Both distillation and membrane desalination technologies require large energy inputs. When fossil fuels are used, these energy sources account for one-third to one-half of fresh water production costs and will exacerbate global warming.
- The expected greater reliance on desalination will cause a regional shift in the proportion of MENA's energy devoted to water supply. Greater reliance on desalination also will demand greater attention to its adverse environmental impacts: greenhouse gas emissions from fossil fuels and managing brine concentrate by-products. While the brine management problem will increase, GHGs can be very significantly reduced using RE alternatives.

## Solar Energy Is MENA's Abundant Renewable Resource

- The region's virtually unlimited solar irradiance—several times larger than total current world energy demand—and proven solar energy power generation technologies will ensure an environmentally sustainable desalinated water supply to MENA and ensure energy security to the water sector. However, to make these energy sources more competitive and viable for use by most of MENA's population, actions must be taken today to encourage investments in the continued development of renewable energy (RE) and increasing the efficiency of desalination technologies. Of the various RE technologies available, concentrating solar power (CSP) is the best match because it is scalable to demand; can provide both peak and baseload electricity; and with heat storage and oversized solar collectors, it can provide a firm power supply 24 h a day.
- If RE replaces fossil fuels except for peaking power, MENA's annual CO<sub>2</sub> emissions could be reduced to 265 million tons by 2050—which is less than current emissions.
- CSP desalination will take time to mainstream because most fossil-fueled desalination plants will not be totally decommissioned until 2041–43. Furthermore, CSP desalination will continue to be more expensive compared to conventional desalination. Thus, during this period, it will be essential that the supply of CSP desalination technology keep pace with demand. Without this technology, a number of coun-

tries will have to mine their groundwater reserves even more intensively to survive in the short to medium terms. Moreover, during this interim period, CSP still will need to be supplemented by fossil fuels for some baseload and peak-power generation.

- Desalination through RE can benefit from RE momentum in MENA countries, as evidenced by the range of policies and targets being set. In particular, synergies can be built with the vision of “green energy” exports to Europe from the MENA countries. The MENA CSP investment plan, co-financed by the World Bank, also is likely to leverage access to markets and financing for CSP. The key barrier to CSP deployment is its present high cost. However, the potential to lower costs is high. Strategic commitment from countries linked to green energy exports to Europe and local manufacturing show great promise and need to be pursued proactively.
- Similarly, programs initiated by MENA countries to increase their share of RE in the overall energy share are encouraging. Notable examples are the United Arab Emirate’s Masdar Initiative, the Qatar National Foundation, and Saudi Arabia’s King Abdullah City for Atomic and Renewable Energy (KA-CARE), Morocco’s Solar Plan and Tunisia’s Solar Plan.

### Costs of Inaction Will Be High

- Desalination will continue to play an ever-increasing role in MENA’s water supply portfolio. However, if the current trend of using fossil fuel for desalination continues in the future, many MENA countries will face serious energy security problems in general and economic problems for oil-exporting countries in particular.
- By 2050, filling the water gap of 200 km<sup>3</sup> will cost approximately \$104 billion (6% of the region’s current GDP). However, if the optimum solutions are not adopted, the adaptation cost could increase to US\$ 300 billion–US\$ 400 billion. Countries will differ markedly based on the severity of their water shortages and projected GDP. In the future, Iraq, Jordan, Morocco, and the Republic of Yemen must be prepared to spend a substantial amount of their GDP on overcoming their water shortages. In the Republic of Yemen, for example, this amount could be as much as 4 percent of GDP.
- Environmental implications of desalination regarding carbon footprint and safe brine disposal will be significant by 2050.

## The Solutions Are at Hand

- MENA will reap major benefits from *coupling desalination with RE sources*. Doing so will ensure a sustainable water supply, energy security to the water sector, and environmental sustainability.
- However, to make these sources more competitive, actions must be taken today to encourage investments in RE technologies and improvements in desalination efficiency. Governments can advance more ambitious national energy plans and targets, provide financial support, moderate perverse tariffs, and develop and enforce comprehensive and consistent environmental legislation. Companies can make operations and supply chains more energy-efficient and form public-private partnerships that expand the range of sustainable energy products. Investors and donors can provide seed money for clean technologies. Governments, industry, and academia all can contribute new research.
- Comprehensive and consistent regional and national environmental legislation is necessary to protect groundwater and shared water bodies from pollution. For such laws to be effective, it is important for countries to jointly plan and implement them. Joint studies and continuous monitoring also should be undertaken to better understand the adverse impacts of brine surface water disposal on marine ecosystems and inland disposal on groundwater aquifers.

## Next Steps

- All MENA countries have set policy targets or created supportive RE policies. However, concrete commitments that drive action on the ground are still missing. More work is needed to prepare bankable RE and RE desalination projects in MENA. Obviously, not all efforts should come from the region itself. The green energy initiative is a significant component of making RE technologies affordable and accessible. EU countries' support to such initiative by adopting friendly policies to facilitate green energy imports to Europe and by making green energy exports from MENA countries to Europe financially attractive is as critical.
- Equally important in the overall RE development agenda are the efforts that developed countries need to make to develop new technologies and/or support production of promising technologies at scale to bring down the cost of RE.<sup>1</sup> For example, the role that the government of Germany has played over the last few years to significantly bring



down the cost of PV is commendable. Due to Germany's adoption of a preferential feed-in tariff policy for PV-based RE sources, significant improvements in PV technology and cost saving have been achieved. These great achievements have helped not only Germany but also other countries to access PV-based RE energy. Similar initiatives could be supported by other developed countries that have comparative advantage in terms of technology and resources, including institutional and human capacity, to achieve better results for the common good.

- Compared to many MENA countries, developed countries that already have strong technological and institutional foundations easily can develop a business model around RE and RE desalination. It would be very important that joint efforts are made to advance the rolling-out of these technologies.

## Note

1. Part of the global support to the RE initiative to increase RE's share in the energy portfolio mix and thus reduce fossil-fuel-based GHG emissions.



## Water Demand and Supply in MENA Region

If current rates of growth continue and the global climate warms as expected in the MENA Region, water demand is expected to increase 50 percent by 2050 (table A.1). Current total water demand exceeds naturally available water supplies by almost 20 percent. By 2050, the water demand gap is projected to grow fivefold (table A.1). This already quite substantial unmet demand clearly reflects the conditions in MENA, in which water shortages are occurring in most countries. Currently, unmet demands are filled primarily through unsustainably mining fossil groundwater reserves and partially by increasing water supplies through desalination.

Based on the average for 2000–09, the current annual water shortage in the MENA Region is approximately 42 km<sup>3</sup>. Within that period, however, year-to-year variations were quite large. Shortages ranged from 24 km<sup>3</sup> in 2004 to 64 km<sup>3</sup> in 2008. These variations resulted from erratic and

**TABLE A.1**

### MENA Annual Water Demand and Supply under Average Climate Change Scenario, 2000–50 (km<sup>3</sup>)

	2000–09	2020–30	2040–50
Total Demand	261	319	393
Irrigation	213	237	265
Urban	28	50	88
Industry	20	32	40
Total Supply	219	200	194
Surface water <sup>a</sup>	171	153	153
Groundwater	48	47	41
Total Unmet demand	42 <sup>b</sup>	119	199
Irrigation	36	91	136
Urban	4	16	43
Industry	3	12	20

Source: FutureWater 2011.

a. Surface water includes river flows into the MENA Region.

b. Summation does not add up due to rounding.

highly variable local rainfall and fluctuations in the volumes of the three major rivers flowing into the region: the Nile, Tigris, and Euphrates.

Per capita renewable water resources in MENA are among the lowest in the world. Moreover, they will deteriorate further in the future mainly due to population growth and likely climate change impacts projected to reduce water availability. Where the average availability of water per capita is low, even slight variations can render entire communities unable to cope and create disaster conditions. The Food and Agriculture Organization of the United Nations (FAO) regards water as a severe constraint to socioeconomic development and environmental protection at levels of total renewable water availability of less than 1,000 m<sup>3</sup> per capita. At levels of annual water availability of less than 2,000 m<sup>3</sup> per capita, water is regarded as a potentially serious constraint and becomes a major problem in drought years. By these criteria,<sup>1</sup> by 2020–30, water availability will severely constrain socioeconomic development in all 21 MENA countries (map A.1).

Under current conditions (2000–09), countries in the Gulf region face the largest per capita water scarcity in MENA. Their average water availability is less than 300 m<sup>3</sup> per capita per year. As noted above, water scarcity is projected to become even more severe in the future as a result of global warming. For example, annual per capita water availability in Morocco will decline from 478 m<sup>3</sup> during 2000–09 to only 76 m<sup>3</sup> in 2020–30 to 72 m<sup>3</sup> in 2040–50.<sup>2</sup> In total, by 2050, 14 of the 21 MENA countries could have less than 200 m<sup>3</sup> of renewable water resources per capita per year.

### Climate Change Will Affect MENA's Future Water Supply

According to the Intergovernmental Panel on Climate Change (IPCC),<sup>3</sup> there is high agreement and evidence that, if current climate change mitigation policies and related sustainable development practices remain the same, global greenhouse gas (GHG) emissions will continue to grow over the next decades. As a result, it is very likely that hot extremes, heat waves, and heavy precipitation events also will become more frequent during the twenty-first century. Under the IPCC's most likely scenario, the expected rise in global surface temperature from 2000 to 2050 will be approximately +1.3°C.<sup>4</sup> An additional increase of +2.6°C will take place from 2050 to the end of the twenty-first century.

Regionally and locally, there are significant departures from these global averages because the distribution of oceans and continents affects the general circulation of the atmosphere. Using northeastern Africa as a test area, monthly temperature and precipitation were simulated for 1960–90. Nine of 22 global circulation models (GCMs) produced statistically coherent results that replicated observed climate variables to an ac-

**MAP A.1**

**Declining per Capita Water Availability: A Growing Threat in MENA**

a. Average water stress by country, 2000–09



b. Average water stress by country, 2020–30



Source: FutureWater 2011.

ceptable degree of accuracy.<sup>5</sup> Subsequently, this volume used climatic indicators based on these nine GCMs to downscale precipitation, temperature, and potential evapotranspiration (ET) for the MENA Region during 2010–50. A statistical downscaling method also was adopted.<sup>6</sup> Using a 10 km grid, climate change impacts were downscaled.

Overall, the country-averaged results indicate that the entire MENA Region will experience a marked increase in temperature and ET through 2050 (figure A.1). During the same period, the changes projected for the western and eastern ends of the region show similar trends for temperature and ET. For example, the temperature in Morocco will increase by approximately 2°C, which is slightly higher than the 1.5°C increase predicted for the United Arab Emirates. Despite Morocco’s greater increase

in temperature, its annual reference ET will increase by approximately 75 mm by 2050. However, for all MENA countries farther east, their increase in annual ET will be on the order of 100 mm by 2050. Given that agriculture is MENA's dominant water-using sector, if current vegetation and cropping systems continue, increased ET will significantly increase future water demand.

An important finding is that precipitation does not have the same definite trends as temperature and ET. In Morocco, for example, annual average precipitation is projected to increase slightly during 2010–15 but then to decrease. In contrast, in the United Arab Emirates, annual precipitation is more or less the same during the entire period. Thus, on average, the relative ranking of precipitation by country will not change much in future (figure A.1).

**FIGURE A.1**

**Five-Year Moving Averages of Projected Precipitation, Temperature, and Potential Evapotranspiration for Morocco and the United Arab Emirates, 2010–50**

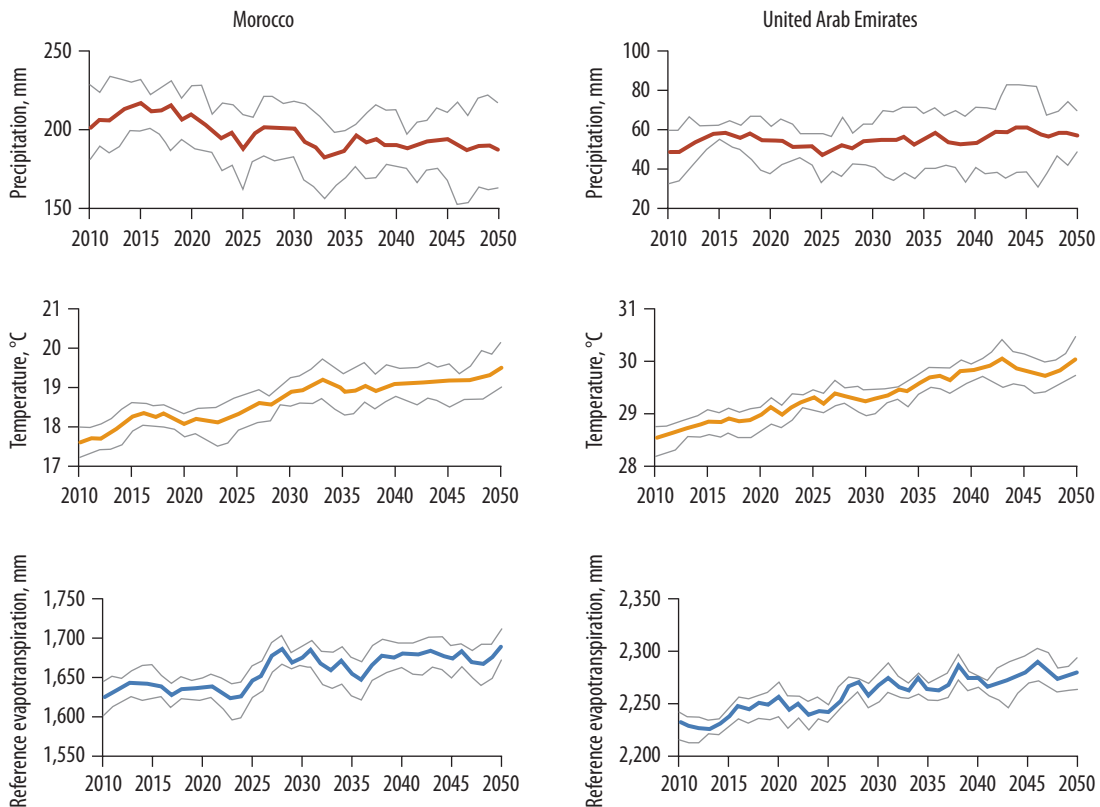

Source: FutureWater 2011.

Note: The gray lines show the results for the second lowest and second highest GCM and are indicators of uncertainty. Uncertainty is greater for precipitation.

Within the country averages discussed above, climate differs spatially.<sup>7</sup> To overcome the large-scale averaging problem, the current study assessed rainfall on a small-scale grid across the entire region to more closely model the actual rainfall distribution. Using this approach, it quickly became apparent that, under the current climate, for example, the coastal areas of Algeria, the Islamic Republic of Iran, Lebanon, Morocco, the Syrian Arab Republic, Tunisia, and the Republic of Yemen are wetter than their arid interiors (map A.2).

By 2020–30, precipitation will decrease in nearly every MENA country along the Atlantic and Mediterranean shores, and inland. The largest decreases will occur in southern Egypt, Morocco, the central and coastal areas of Algeria, Tunisia, central Libya, Syria, and the central and eastern parts of the Islamic Republic of Iran.

Decreases will range from 5 to 15 percent for most countries, with a decrease of more than 20 percent in southern Egypt. Increases in precipitation are projected for the Sahara fringe in the southern MENA Region, and along the Red Sea and Indian Ocean hinterlands in Saudi Arabia, the Republic of Yemen, and in eastern Islamic Republic of Iran. While the increases range from 0 to 20 percent, practically, the increase in actual precipitation is very small because precipitation in these regions is very low to begin with. For example, a 20 percent increase in precipitation in southeastern Libya amounts to only 5 mm a year. With a few exceptions, these trends will persist for 2040–50.

Temperature and ET follow similar spatial trends. However, temperature changes in coastal areas tend to be smaller than temperature changes in the arid interiors such as the Sahara regions. The smallest increases in temperature ( $<0.15^{\circ}\text{C}$ ) occur in northern Libya, northern Egypt, Israel, Lebanon, Jordan, and western Syria. The largest temperature increases ( $>0.65^{\circ}\text{C}$ ) are found in northern Morocco, northern and southern Algeria, southern Saudi Arabia, southern Iran, and central and northern Republic of Yemen and Oman. Throughout the region, annual ET increases from the coasts inland. For 2020–30, the annual ET is projected to increase in western and eastern MENA countries and in coastal areas by 2–9 percent. However, inland regions of some MENA countries, including Algeria, the Arab Republic of Egypt, Jordan, and Libya will see a small decrease in annual ET. As the region continues to warm, ET will further increase.

## Precipitation

Based on the period 2000–09, rainfall in the MENA Region provides an average of  $1,122 \text{ km}^3$  a year. However, 75 percent of this rain falls on only four countries: The Islamic Republic of Iran (31 percent), Algeria

**MAP A.2**

**Projected Changes in Precipitation across MENA, 2010–50**

**a. Precipitation current climate (mm)**

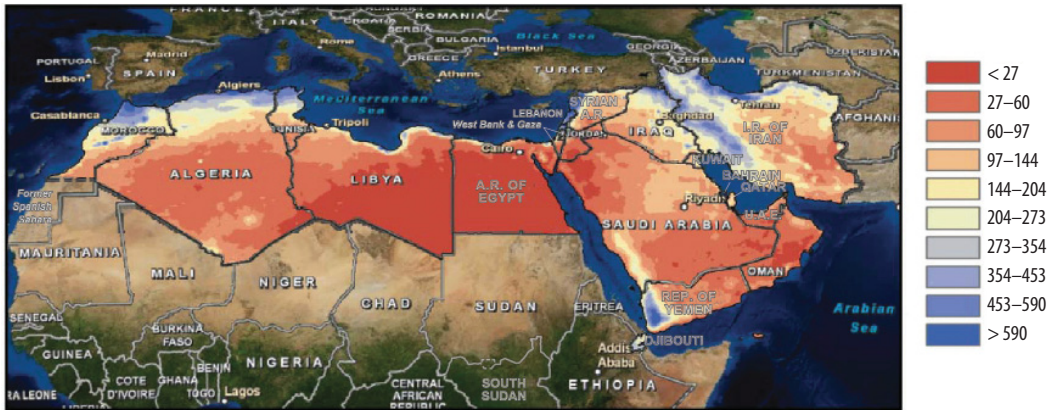

**b. Precipitation anomaly 2020–30 (Percent)**



**c. Precipitation anomaly 2040–50 (Percent)**

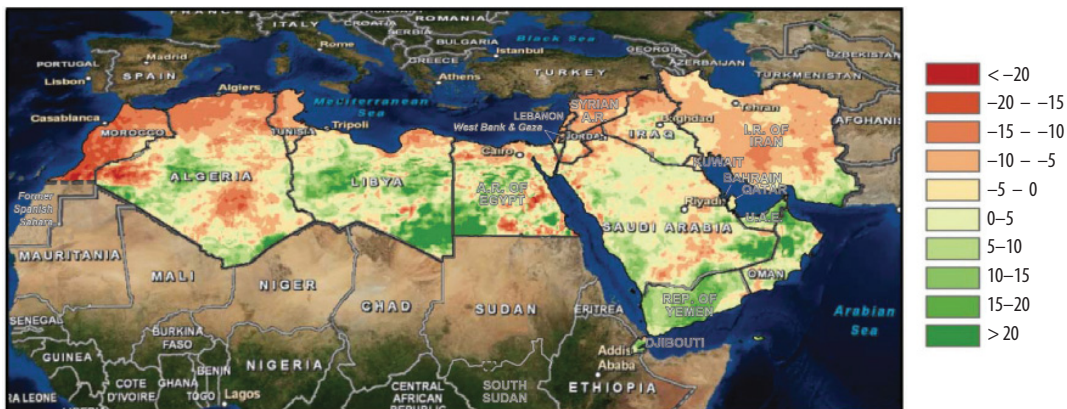

Source: FutureWater 2011.

Note: The precipitation anomaly is the predicted percentage change over the current climate baseline.



FIGURE A.2

Wide Range of Average Annual Precipitation among MENA Countries, 2000–09

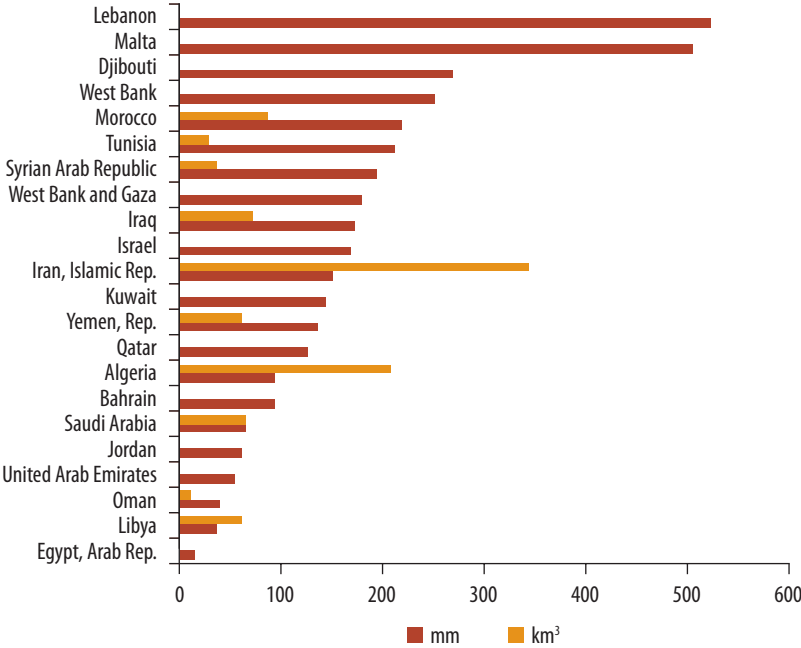

Source: FutureWater 2011.

(19 percent), Saudi Arabia (13 percent), and Morocco (8 percent). An important point is that when precipitation is expressed in km<sup>3</sup>, as it is in the current study to estimate the MENA water balance, the overall total is strongly biased by the largest countries (figure A.2).

In all MENA countries except Egypt, Iraq, and Syria, precipitation is the principal renewable water resource.<sup>8</sup> Annual rainfall variability for the region averages approximately 30 percent. However, some countries such as Djibouti, Morocco, Oman, and Tunisia show exceptional annual variability of approximately or above 40 percent. Countries with a high variation in precipitation require a higher adaptive capacity, which may include more reservoir storage, a greater reliance on groundwater, or greater on-demand desalination capacity.

Precipitation feeds some perennial rivers, but few flow to the sea. The exceptions are in Morocco, Algeria, and Tunisia in the west and the Islamic Republic of Iran in the east. Rarely, exceptionally heavy storms in the northern United Arab Emirates, Oman, Lebanon, the Republic of Yemen, and Algeria cause floods that reach the seas. Precipitation not lost to the sea or to evaporation will be stored in reservoirs and underground, in either the soil profile or deeper aquifers.

The exact amount of precipitation stored by reservoirs in MENA at any one point is difficult to assess with accuracy due to data unavailability.<sup>9</sup> However, the current estimate is approximately 400 km<sup>3</sup>. Most of this volume (43 percent) lies behind the Aswan High Dam in Egypt and behind dams in Iraq (35 percent), the Islamic Republic of Iran (8 percent), Syria (5 percent), and Morocco (4 percent). Reservoir storage generally supplies the capacity to smooth out interseasonal and interannual variations in precipitation. However, reservoirs increase water resources only if they stop them from flowing to waste, which includes the sea or salt flats; or shift the pattern of use for irrigation from hot season to cool season crops.

### **Evapotranspiration**

ET is the largest consumer of water in the MENA Region. Over the period 2000–09, ET averaged 1,141 km<sup>3</sup> a year or 91 km<sup>3</sup> a year more than total precipitation. The vast majority of MENA countries require more water for agriculture than their rainfall can provide. The water gap is made up by either river inflows to the region or local groundwater.

### **Externally Renewable Water Resources**

Sixty percent of renewable water flows into the MENA Region from external sources. Three countries—Egypt, Iraq, and Syria—rely on these transboundary inflows to provide the bulk of their renewable water supplies. Egypt, in particular, is almost completely dependent on the Nile inflow. Volumetrically, the total average transboundary inflows to MENA is approximately 115 km<sup>3</sup> per year.

### **Groundwater**

Groundwater is a vital resource throughout most of MENA. It is the mainstay of year-round domestic and industrial water supplies and irrigation in most countries, except in the Gulf Region. Although the adverse impacts of the unsustainable management of groundwater are well known throughout MENA, there is very little consistent information on the occurrence and availability of this resource. Some countries—including Saudi Arabia and the United Arab Emirates—have undertaken intensive surveys of their groundwater resource and its use, but most have only partial information. Indeed, for most countries, only the rates of use can be determined, and even these only indirectly from the area and type of crops irrigated and the abstraction for domestic and industrial use. Accordingly, this regional study estimated current fresh groundwater resources as the sum of simulated groundwater recharge (determined from

hydrological modeling) and the current extraction rates.<sup>10</sup> Overall, current MENA fresh renewable groundwater resources are estimated at 48 km<sup>3</sup> per year, equivalent to 4 percent of precipitation.

### Future Water Availability

The future water availability for the entire MENA Region is predicted to decline as a result of global warming. Water balance modeling indicates that total internal renewable water resources—runoff and groundwater recharge—will decline significantly as a combined effect of the changes in precipitation and ET. The total MENA external renewable water resources show a very small increase primarily because of precipitation increases in the Nile basin south of the MENA Region. However, the decline in the local precipitation-ET balance exceeds the gains from external renewable water resources. Thus, total renewable water resources show a negative trend that, when aggregated over the entire MENA Region, is approximately 12 percent (approximately 47 km<sup>3</sup>) a year (figure A.3). To contextualize the significance of this impact, today’s domestic water demand is approximately 28 km<sup>3</sup> a year.

FIGURE A.3

### Predicted Water Availability in the MENA Region, 2010–50

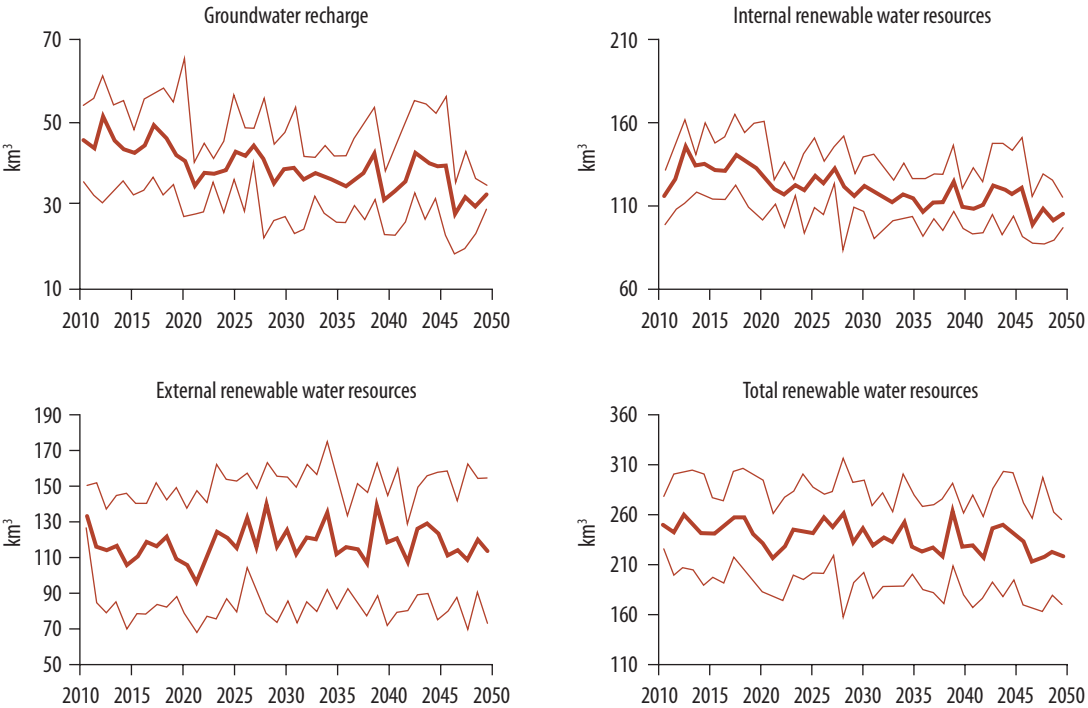

Source: FutureWater 2011.

Note: The thick line is the average of the nine global circulation models (GCMs); the thin lines show the second wettest and second driest GCM.

### MAP A.3

## Predicted Changes in Water Availability in the MENA Region, 2010–50

### a. Precipitation

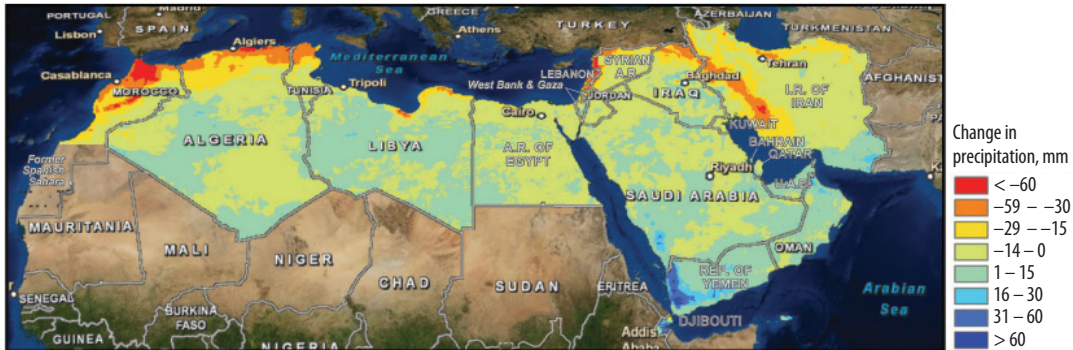

### b. Runoff: Internally renewable water resources



Source: FutureWater 2011.

The results of the hydrological modeling vary considerably so they should be interpreted with care. External inflows into the region from the Nile, Tigris, and Euphrates are an important component of the region's water balance. Future inflows will be affected not only by climate change and variability but also by the decision of upstream riparians to divert more water for their own uses. The values used in this volume are based on the best available data. In the future, data quality will be better so the volumes of external inflows are likely to be revised. Internally within MENA Region as well, water balances for countries will change based on allocations by riparian countries. In addition, for groundwater, the modeling exercise assumes no flow among countries. As more data become available, this assumption may have to be revised.

Nonetheless, given that groundwater recharge and internal renewable water resources show a decline under all GCMs, it is safe to assume that, overall, water availability in the future will decrease. In addition to these longer term trends, MENA countries vary greatly in their hydrological responses to climate change (map A.3). Most notably, increased precipitation

over the southwestern Arabian Peninsula and southeastern Islamic Republic of Iran probably will increase flood hazards and risks in these areas.

Internal renewable water resources exhibit a negative trend throughout the region, with the exception of central Islamic Republic of Iran and Syria, the southwestern areas of Saudi Arabia and the Republic of Yemen, and Algeria along the area south of the Atlas Mountains. The largest changes are observed in Jordan (-138 percent), Oman (-46 percent), Saudi Arabia (-36 percent), and Morocco (-33 percent).

Groundwater recharge is predicted to decrease in almost all MENA countries. This decrease generally is much stronger than the projected decrease in precipitation due to the nonlinearity of hydrological processes. In relative terms, some of the largest changes in groundwater recharge (more than -40 percent) are predicted for the Gulf states, Oman, Saudi Arabia, and the United Arab Emirates. Even in some of the wetter countries, the predicted changes remain very considerable (for example, Morocco -38 percent, Iraq -34 percent, and the Islamic Republic of Iran -22 percent).

The reduction in renewable water supplies will create a major planning problem for all MENA countries (table A.1). First, population pressure will increase demand for water supplies. Second, new sources of supply will have to be secured. The following section looks at current water demands and their likely future growth. Subsequently, the regional water balance is determined from a comparison of renewable supplies with demand.

## Current and Future Water Demand

### Domestic Demand

Population growth is the primary driver for domestic and industrial water demand. Population and economic prosperity directly drive domestic water demand (figure A.4). With increasing prosperity, domestic water withdrawals per capita increase as households invest in bathrooms, washing machines, gardens, and, eventually, for some, swimming pools. From the baseline period 2000–09, current annual MENA domestic water demand is estimated at 28 km<sup>3</sup>.

Future increases in domestic water demand will not be linear because, after a certain point, the growth rate declines with increasing gross domestic product (GDP) per capita.<sup>11</sup> Once GDP per capita approaches US\$70,000 a year, water consumption will level off at approximately 200 m<sup>3</sup> per capita, or approximately 550 liters per capita per day.

However, in the southwest United States and in the Abu Dhabi Emirate in the MENA Region, for example, those with high incomes who live

FIGURE A.4

### Relation between per Capita Domestic Water Withdrawals and GDP

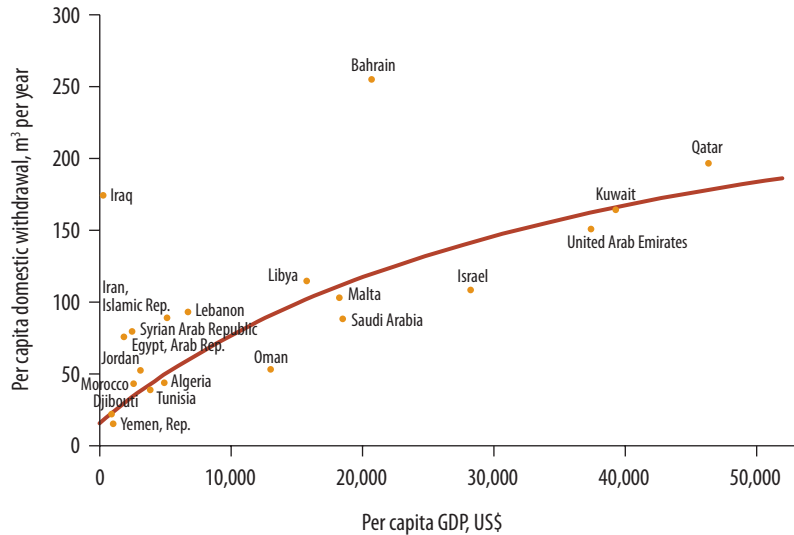

Source: FutureWater 2011.

in arid climates generally are willing to pay for the amenity value of water used in gardens and swimming pools (figure A.5). The very rich in MENA comprise the less than 5 percent of the region's population who have more than US\$14,000 per capita GDP. However, precisely because they are so few, they have a very modest effect on total domestic water demand. In contrast, in 2010 the per capita GDP of more than 50 percent of the region's population—approximately 180 million people—was US\$2,760. This figure indicated a per capita domestic water demand of approximately 35 m<sup>3</sup> a year, or approximately 100 liters per capita per day. Consequently, it is assumed that, as GDP improves, future domestic per capita water demand will follow the red line shown in figure A.4.

The combined population of the 21 MENA countries is projected to more than double by 2050. The most reliable population growth forecasts project that MENA's population will grow from 316 million in 2000 to 697 million in 2050 (CIESIN 2002a). Egypt and the Republic of Yemen will have the largest population increases.

For the same period, the Center for International Earth Science Information Network also projected on a country-by-country basis that regional GDP will grow from its current US\$1.6 trillion to 6.5 trillion by 2030–40, and reach US\$19 trillion by 2040–50 (CIESIN 2002b).

The combined impact of population and GDP growth will cause MENA's total domestic water demand to more than triple by 2050. Cur-

**FIGURE A.5**

**Global Comparisons of per Capita Domestic Water Demand**  
*(liters per capita per day)*

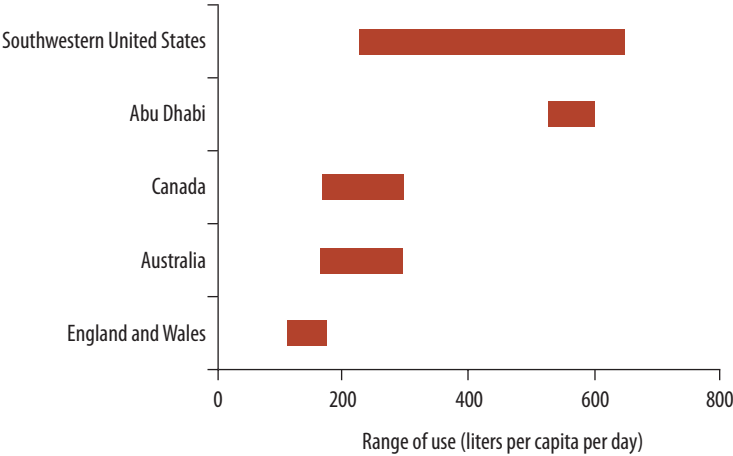

Sources: Heaney and others 1999; Ofwat.gov.uk. 2009.

rent water demand will grow from 28 km<sup>3</sup> a year to 50 km<sup>3</sup> by 2030–40, and to 88 km<sup>3</sup> by 2040–50.

**Industrial Demand**

Similar to domestic water demand, industrial water demand is a function of total GDP and GDP per capita. If a country produces more GDP in line with population growth, it is assumed that industrial water demands will grow at the same rate as GDP. However, if GDP grows faster than the population growth, it is assumed that a richer and more sophisticated population will introduce more efficient and environmentally sustainable industrial water use, thus slowing the growth of industrial water demand below the rate of GDP growth. On this basis, MENA’s industrial water demand is projected to double by 2050. Current MENA industrial water demand is estimated to be 20 km<sup>3</sup> a year. This demand is projected to grow to 32 km<sup>3</sup> a year by 2030–40 and 41 km<sup>3</sup> a year by 2040–50.

**Irrigation Demand**

The distribution of current irrigated areas across the MENA Region was determined from an analysis of satellite imagery supplemented by extensive regional data.<sup>12</sup> Released in 2007, the map shows the proportion of area equipped for irrigation in approximately year 2000 (map A.4).<sup>13</sup> Major irrigation areas in MENA, including the Nile delta in Egypt, the

## MAP A.4

## Distribution of MENA Areas Equipped for Irrigation, 2009



Source: Siebert and others 2007.

Euphrates and Tigris basin in Iraq, northern Islamic Republic of Iran, central Saudi Arabia, western Republic of Yemen, Oman's Batinah coast, and the Sebou and Oum el Rbia systems in Morocco are clearly shown in figure 2.9. Not all equipped area is actually irrigated; and within most countries, the area irrigated varies annually.

At the beginning of this century, the total irrigated area in MENA was approximately 21 million ha. The corresponding irrigation water demand was approximately 213 km<sup>3</sup> a year.<sup>14</sup> Seven countries account for 90 percent of MENA's irrigated area, and two countries—the Islamic Republic of Iran and Iraq—account for 50 percent. Irrigation currently accounts for 81 percent of all water demand in the region.

Future irrigation demand was determined by irrigation potential,<sup>15</sup> defined for this volume as the difference between the currently irrigated area and the total land area suitable for irrigation for which renewable water resources are available. Generally, irrigation potential is constrained by renewable water resources. However, in many arid countries, irrigation is sustained through mining fossil groundwater reserves. This activity is particularly prevalent in Jordan, Libya, Saudi Arabia, the United Arab Emirates, and the Republic of Yemen. Through depleting the aquifers, the area under irrigation can exceed the irrigation potential.

For this volume, projections of future irrigation water demand to 2050 assumed that agricultural water demand would not exceed available water resources.<sup>16</sup> However, future agricultural water demand and renewable water supplies will be strongly affected by global warming. Higher temperatures will increase the amount of water transpired by vegetation and change the distribution and magnitude of precipitation. Thus, higher



**TABLE A.2****MENA Irrigation Water Demand** (*km<sup>3</sup> per year and percent increase over current demand*)

Climate scenario	Average	Dry	Wet
Current 2000–09	213	—	—
2020–30	237 (+11%)	254 (+19%)	222 (+4%)
2040–50	265 (+24%)	283 (+33%)	246 (+15%)

Source: Adapted from FutureWater 2011.

Note: — = not available.

temperatures will negatively affect the volume and availability of renewable water resources and the viability of rainfed agriculture.

Taking these constraints into account, irrigation water demand is projected to increase by 2050. If global warming induces a wetter and warmer climate, irrigation water demand will increase by 15 percent over current demand (table A.2). Conversely, if the future climate is warmer and drier, it is expected that irrigation demand will increase by 33 percent. Under the most likely (average) trend, demand will increase by approximately 25 percent.

While climate change will modestly affect irrigation water demand, it will have a far greater impact on water resources. If the climate turns out to be drier than present, renewable water resources may be reduced by more than 40 percent.

### Regional Water Balance

The water balance for the MENA Region indicates that the current shortage of renewable supplies is approximately 42 km<sup>3</sup> a year (table A.3). In several countries, part of the MENA demand gap has been met primarily through unsustainably mining fossil groundwater reserves and partly through producing desalinated water, particularly around the Gulf region.

Groundwater mining provides a short-term fix to the supply problem. However, without an orderly transition to more sustainable supplies, the danger remains that considerable sections of rural economies could collapse from lack of water. This scenario is particularly serious for Oman, whose groundwater mining is causing seawater intrusion and salinization of soils along the Batinah coast; and for the Republic of Yemen, whose aquifers are near exhaustion. Some countries have imposed conservation policies. For example, in Saudi Arabia and the United Arab Emirates, subsidies for irrigated agriculture have been significantly reduced (chapter 3).

**TABLE A.3****MENA Water Demand Gap under Three Climate Scenarios, 2000–50 ( $\text{km}^3$  per year)**

Climate scenario	2000–09	2020–30	2040–50
Average	—	—	—
Total demand	261	319	393
Demand gap	42 (16%)	119 (37%)	199 (51%)
Dry	—	—	—
Total demand	—	336	412
Demand gap	—	199 (56%)	283 (69%)
Wet	—	—	—
Total demand	—	303	375
Demand gap	—	42 (14%)	85 (23%)

Source: Adapted from FutureWater 2011.

Note: — = not available.

**Future Water Balance**

In the future, MENA's water shortage will increase substantially under all climate change scenarios because of increased demand and reduced supply. If climate follows the predicted average trend, by 2040–50, the water shortage will grow from the current 42  $\text{km}^3$  per year to 199  $\text{km}^3$  per year, which is approximately five times the current demand gap (table A.3).

An important point to remember is that the average for any period masks considerable interannual climate variation. For instance, as noted earlier, the annual variation in the supply gap for 2000–09, which averaged 42  $\text{km}^3$ , ranged from 24  $\text{km}^3$  in 2004 to 64  $\text{km}^3$  in 2008. When designing future supply augmentation responses, considerable care will be needed to include this interannual uncertainty around the predicted trends and provide sufficient capacity and storage to meet the impact of droughts.

The magnitude of the demand and supply components for the dry climate scenario over time appears in figure A.6.

If the dry climate scenario occurs, the demand gap will reach 283  $\text{km}^3$  per year—or more than all current regional water demand (figure A.7).

Even under the wet climate scenario, in the longer term, the demand gap will increase (figure A.8). Compared with today, by 2050, the demand gap will double to 85  $\text{km}^3$  per year.

**Assessment of Individual Countries**

The impact of change in climate and irrigation and domestic and industrial demand was assessed separately for the 21 countries in the MENA Region (figure A.9). This volume also assessed the total water demand and unmet demand for each of the MENA countries (table A.4). Demand

**FIGURE A.6**

**Balance of Demand and Supply in MENA under Average Climate Change Scenario, 2000–50**

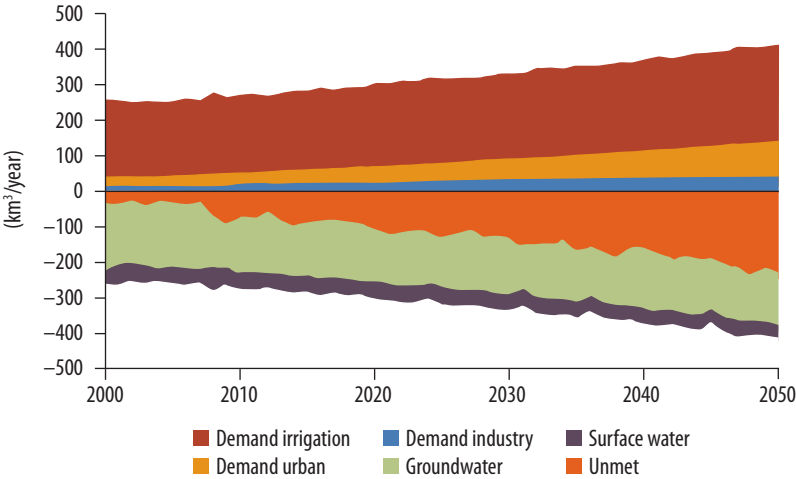

Source: FutureWater 2011.

**FIGURE A.7**

**Balance of Demand and Supply in MENA under Dry Climate Change Scenario, 2000–50**

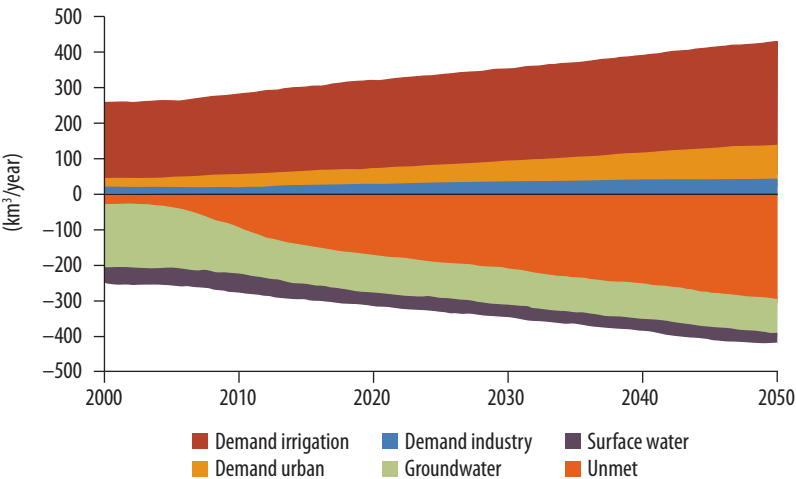

Source: FutureWater 2011.

will increase for all countries as a result of the higher evaporative demand of irrigated agriculture and the increase in domestic and industrial needs.

From the 2009 baseline, overall demand will increase by approximately 25 percent in 2020–30 and by approximately 60 percent in 2040–50.

**FIGURE A.8**

**Large Water Demand Gap in MENA Countries under Average Climate Change Scenario, 2000–50**

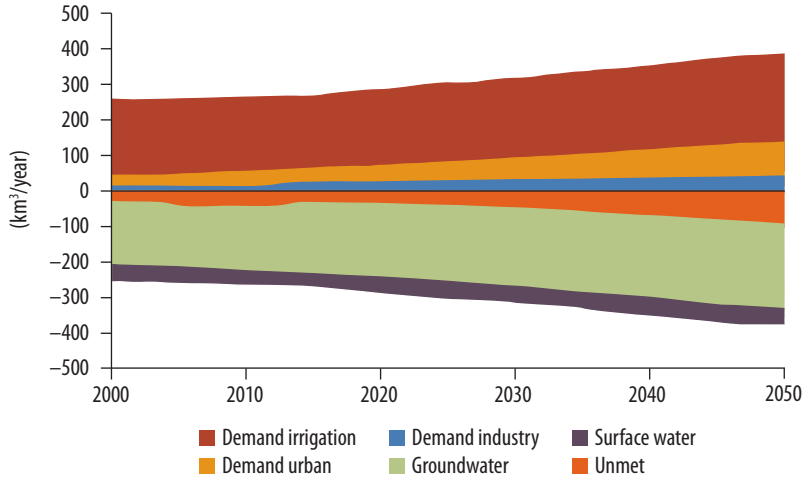

Source: FutureWater 2011.

**FIGURE A.9**

**Assessment of Individual Countries**

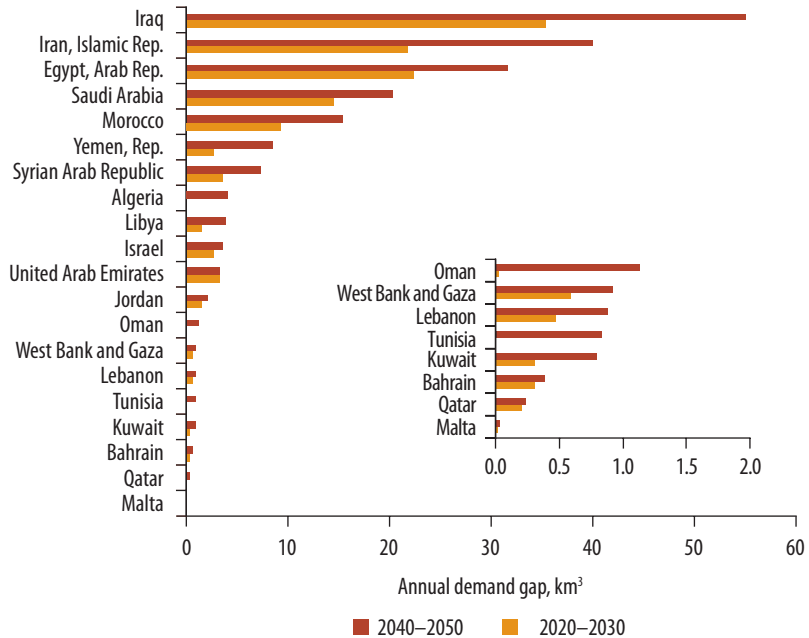

Source: Modified from FutureWater 2011.

Note: Interior figure is same as large figure but scale is enlarged.

**TABLE A.4****Current and Future Water Demand and Unmet Demand Gap under Average Climate Projection (MCM)**

Country	Demand			Unmet		
	2000–09	2020–30	2040–50	2000–09	2020–30	2040–50
Algeria	6,356	8,786	12,336	0	0	3,947
Bahrain	226	321	391	195	310	383
Djibouti	28	46	84	0	0	0
Egypt, Arab Rep.	55,837	70,408	87,681	2,858	22,364	31,648
Iran, Islamic Rep.	74,537	84,113	97,107	8,988 <sup>a</sup>	21,767	39,939
Iraq	50,160	67,235	83,803	11,001 <sup>a</sup>	35,374	54,860
Israel	2,526	3,396	4,212	1,660	2,670	3,418
Jordan	1,113	1,528	2,276	853	1,348	2,088
Kuwait	508	867	1,216	0	313	801
Lebanon	1,202	1,525	1,869	141	472	891
Libya	4,125	4,974	5,982	0	1,382	3,650
Malta	45	62	75	0	22	36
Morocco	15,739	19,357	24,223	2,092	9,110	15,414
Oman	763	1,091	1,709	0	24	1,143
Qatar	325	381	395	83	209	246
Saudi Arabia	20,439	22,674	26,633	9,467	14,412	20,208
Syrian Arab Republic	15,311	17,836	21,337	323	3,262	7,111
Tunisia	2,472	3,295	4,452	0	0	837
United Arab Emirates	3,370	3,495	3,389	3,036	3,243	3,189
West Bank and Gaza	460	680	1,022	308	591	925
Yemen, Rep.	5,560	7,069	12,889	1,120	2,573	8,449
MENA	261,099	319,138	393,082	42,125	119,443	199,183

Source: Adapted from FutureWater 2011.

a. Current unmet demand gap for Iraq and the Islamic Republic of Iran are estimated, respectively, at 11 and 9 km<sup>3</sup>. Intuitively, these gaps look unrealistic for countries that normally have positive national level water balances. This can be explained by the sustained drought experienced in the two countries in the last decade. Similarly, the current demand gap of zero until 2050 for Kuwait, Libya, Malta, and, especially for Djibouti, can be explained by the generalized national water balance approach used in the hydrological analysis and the extremely poor and unreliable data quality for some of the countries. For example, although, in reality, Djibouti suffers from chronic water shortage, every database, including FAO's AQUASTAT, shows the opposite.

However, large variation occurs when countries with relatively high domestic and industrial demand show larger proportional increases compared to other countries. The larger countries with extensive agricultural demands account for the major share of the increased future demand.

The growth of the demand gap will be dramatic for all countries. Countries that currently face no or limited water shortages will be confronted with large water deficits in the near and distant future.

Egypt, the Islamic Republic of Iran, Iraq, Morocco, and Saudi Arabia will see their annual water shortages increase by 10–20 km<sup>3</sup> in 2020–30, and up to 20–40 km<sup>3</sup> in 2040–50. A comparison of the water gap for the average climate scenario for all countries is shown in figure 3.2. While the magnitude of the water gap in the least stressed countries looks relatively small compared with the huge gap for Iraq in 2040–50, when the scale is

expanded for these countries, the challenge of meeting their water gaps appears formidable.

Uncertainty in these predicted country deficits was determined from the analysis of dry and wet climate projections.<sup>17</sup> Changes in total demand as a function of climate change are modest compared with the increase in water shortage caused by changes in water supply. In Egypt, with its very climate-sensitive Nile basin as its sole water source, water will be short on the order of 50–60 km<sup>3</sup> per year according to the dry projections, but there will be no real shortage in case of the wet projection. For other countries the differences among the climate projections are more modest. For example, in Morocco, the annual difference in expected water shortage in 2040–50 ranges from 8 km<sup>3</sup> for the wet climate to 20 km<sup>3</sup> per year for the dry climate, and 15 km<sup>3</sup> per year for the average climate projection. Other countries show a similar behavior.

The only alternative options to close the growing water demand gap are better management of available water and finding new sources of supply. Appendix B discusses options for demand management. Desalination of seawater and brackish water, increased reservoir capacity, and reuse of wastewater, among others, constitute supply-side management options. Appendix B also discusses the potential of these resources in the MENA Region.

## Notes

1. Water scarcity is a relative concept. It is partly a “social construct” in that it is determined by both the availability of water and consumption patterns.
2. This estimate is based on future population and GDP growth projected for Morocco by CIESINa, FAO 2006, and IPCC’s climate change projection (IPCC 2007), which estimated a decrease in water availability of approximately 33 percent by 2050.
3. To explore alternative development pathways, the IPCC uses four scenarios that cover a wide range of demographic, economic, and technological drivers and their resulting GHG emissions. The four scenarios are subdivided into a number of groups that describe alternative directions depending on the assumed changes in the demographics, economic factors, and technologies.
4. The IPCC’s most likely climate change scenario, A1B, is an intermediate between the B1 (smallest GHG emissions) and A2 (largest GHG emissions). The A1B scenario assumes a world of rapid economic growth, a global population that peaks in mid-century, and the rapid introduction of new and more efficient technologies. A1B also assumes that energy will be balanced across both fossil-intensive and renewable sources and that similar efficiency improvements will apply to all energy supply and end-use technologies. GHG emissions of the A1B scenario show a rapid increase during 2000–50 and a smaller decrease for 2050–2100.

5. In FutureWater's Middle-East and Northern Africa Water Outlook (2011), chapter 3 describes the analytical process used to select appropriate GCMs and the methods used to downscale their outputs to country and local levels.
6. Two methods commonly are used in downscaling. *Statistical downscaling* uses observed climate records to adjust GCM output so that the statistical behavior during a historical period is similar. *Dynamic downscaling* nests a regional climate model (RCM) at a higher resolution in the domain of the GCM. The GCM provides the boundary conditions, and the RCM generates output at a higher resolution. Each method has its merits and demerits.
7. To map spatial variability, climate projections for temperature, precipitation, and ET were downscaled at 10 km by a 10 km grid that covered all MENA countries for 2020–30 and for 2040–50.
8. Egypt, Iraq, and Syria rely on transboundary inflows to provide the bulk of their renewable water supplies.
9. Data on major reservoirs were available for only six countries. For other countries, the average volume and depth were obtained from the Global Lakes and Wetlands Database (Lehner and Doll 2004).
10. In this volume, “effective groundwater storage capacity” was assumed to be the sum of 10 times the annual gross groundwater recharge plus 25 times the current overdraft. A major assumption was that the maximum monthly withdrawal of groundwater equals 5 percent of the “effective groundwater storage capacity.” The assumption was based on expert analysis that, on average, groundwater resources are more or less depleted after 25 years of overdraft. Similarly, it was assumed that the buffer capacity of the annual recharge would last for 10 years.
11. GDP is used in the current analysis at purchasing power parity.
12. The analysis by FAO and Kassel University was supplemented by an extensive FAO database collated from MENA countries' statistical offices (FAO 2006; Siebert and others 2007).
13. The entire MENA Region was divided into a grid with a resolution of 5 minutes of arc. This resolution is approximately equivalent to a grid of 10 km by 10 km.
14. Irrigated area was assessed by FAO AQUASTAT using country-derived data covering 1996–2007. There is no consistent set of regional irrigation data for any one year.
15. However, methods to compute irrigation potential vary from one country to another, and there is no homogeneous assessment of this indicator across MENA countries. The concept of irrigation potential also is not static. It varies over time in relation to the country's economic circumstances or as a result of increased competition for water for domestic and industrial use.
16. Assessment of area in MENA under irrigation in 2050 was done for this study on a country basis through an iterative process based on the “Agriculture towards 2050” (AT2050) estimates of aggregated agricultural demand (FAO 2006). The AQUASTAT information base provided estimates of base year (2005–07) values of land under irrigation, cropping patterns and cropping intensities in irrigation, and national projections for irrigation development in forthcoming years. The AT2050 study estimated aggregated agricultural demand by 2030 and 2050. On the basis of these estimates in combination with information from the Global Agro-Ecological Zones database, MENA

- areas under agricultural production and crop yields for irrigated agriculture were deduced for the base year, 2030, and 2050. This information was used to derive a set of future crop factors and cropping intensities that were entered in a water balance model that considered all users and sources of supply.
17. In contrast to the normal approach of first ranking the GCMs from dry to wet and then doing the analysis, all GCMs were used in the modeling analysis, and results were ranked from dry to wet. Inputs for the supply and demand analysis also were taken from the modeled results for the second driest, the mean, and the second wettest. In other words, this approach derived the statistics from the modeled results, rather than doing statistics first. With this method, the three projections can be from different GCMs for different countries.

## References

- CIESIN (Center for International Earth Science Information Network). 2002a. *Country-Level Population and Downscaled Projections Based on the A1, A2, B1, and B2 Marker Scenarios, 1990–2100*. Digital version. Palisades, NY: CIESIN, Columbia University. <http://www.ciesin.columbia.edu/datasets/downscaled>.
- \_\_\_\_\_. 2002b. *Country-Level GDP and Downscaled Projections Based on the A1, A2, B1, and B2 Marker Scenarios, 1990–2100*. Digital version. Palisades, NY: CIESIN, Columbia University. <http://www.ciesin.columbia.edu/datasets/downscaled>.
- FAO (Food and Agriculture Organization of the United Nations). 2006. *World Agriculture: Towards 2030/2050: Prospects for Food, Nutrition, Agriculture and Major Commodity Groups*. Interim Report. Rome: Global Perspectives Studies Unit. [http://www.fao.org/fileadmin/user\\_upload/esag/docs/Interim\\_report\\_AT2050web.pdf](http://www.fao.org/fileadmin/user_upload/esag/docs/Interim_report_AT2050web.pdf).
- FutureWater. 2011. *Middle-East Northern Africa Water Outlook. Final Report*, commissioned by the World Bank, W. Immerzeel, P. Droogers, W. Terink, J. Hoogeveen, P. Hellegers, and M. Bierkens (auth.). Future Water Report 98, Wageningen, the Netherlands. [www.worldbank.org/mna/watergap](http://www.worldbank.org/mna/watergap).
- IPCC (Intergovernmental Panel on Climate Change). 2007. *Climate Change 2007: Synthesis Report*. Contribution of Working Groups I, II and III to the Fourth Assessment Report of the IPCC (AR4). Geneva. [http://www.ipcc.ch/pdf/assessment-report/ar4/syr/ar4\\_syr.pdf](http://www.ipcc.ch/pdf/assessment-report/ar4/syr/ar4_syr.pdf).
- Lehner, B., and P. Döll. 2004. GLWD (Global Lakes and Wetlands Database). GLWD Documentation. [http://www.worldwildlife.org/science/data/GLWD\\_Data\\_Documentation.pdf](http://www.worldwildlife.org/science/data/GLWD_Data_Documentation.pdf).
- OFWAT (Office of Water Services). 2009. “Price Review,” OFWAT, <http://www.ofwat.gov.uk/pricereview/pr09faqs/>.
- Siebert, S., P. Doll, S. Feick, J. Hoogeveen, and K. Frenken. 2007. *Global Map of Irrigation Areas*. Version 4.0.1. Land and Water Digital Media, Series 34. Frankfurt am Main: Johann Wolfgang Goethe University; Rome: Food and Agriculture Organization of the United Nations. <http://www.fao.org/nr/water/aquastat/irrigationmap/index10.stm>.



## Imperative for Demand and Supply Management

Despite the ever-increasing water scarcity, in response to countries' concerns about food security, most water in MENA continues to be used to grow low-value crops. Irrigated agriculture accounts for approximately 81 percent of regional water use. Despite the predominance of modern irrigation systems, only 50–60 percent of this water use is efficient. Similarly, municipal and industrial water supplies are used inefficiently. In some cities, losses from these supplies reach 30–50 percent, compared to a global best practice benchmark of approximately 10 percent.

Excess demand in all water-using sectors is stoked by pervasive and perverse subsidies. In addition, varying levels of transparency and governance give water agencies and utilities few incentives to improve service standards and promote water conservation. Given the high cost of new water supplies, adding new and more expensive water to such inefficient systems and uses clearly is not economically rational. As water supplies become more limited, there also is the question of water use allocation choices. On the hottest days, irrigation of 1,000 hectares (ha) in MENA consumes the equivalent of the water consumption of a city of 2 million people (Tunisia 2006)!<sup>1</sup> Thus, demand management should be the first line of action in any water resources management action plan.

Nevertheless, due to the region's absolute water scarcity, demand management alone will not solve the water scarcity in MENA. Even after all demand management options have been fully implemented, there still will be gaps that need to be filled with supply augmentation options. Therefore, supply augmentation should be part of the solution. However, conventional supply management options are limited.

### Improving Institutions

In most MENA countries, water policy, whether explicit or implicit, has undergone three phases (World Bank 2007). The first phase evolved over

millennia. As societies grew, they adapted to the variability and scarcity of water. They developed elaborate water institutions and complex structures that helped the region spawn some of the world's oldest and most accomplished civilizations.

The second phase emerged in the twentieth century. As their populations and economies grew, governments increasingly focused on securing water supply and expanding services. The public sector took the lead in managing huge investment programs. To capture available fresh water, the region's rivers are the most heavily dammed in the world; water supply and sanitation services are relatively widespread; and irrigation networks are extensive. In the 1960s, when low-cost drilling technology became available, individuals began tapping into aquifers on a scale that overwhelmed the capacity of regulators to control the extraction. As a consequence, MENA not only is using a greater share of its renewable water resources than any other region but also is using more water than it receives each year.

Initiated a couple of decades ago, the third phase is slowly introducing a series of technical and policy changes in the region's water sector to avoid the economic and social hardships that could result from water shortages. In many MENA countries, supply options are reaching their physical and financial limits so improved water management is essential. This necessity is forcing a transition from focusing on augmenting supply and providing direct service to concentrating on water management and regulation of services. These changes are helping governments consider the entire water cycle rather than its components. Governments are using economic instruments to allocate water according to principles of economic efficiency and are developing systems that have built-in flexibility to manage variations in supply and demand. The changes include planning that integrates water quality and quantity and considers the entire water system; promotes demand management; reforms tariffs for water supply, sanitation, and irrigation; strengthens government agencies; decentralizes responsibility for delivering water services to financially autonomous utilities; and more strongly enforces environmental regulations.

Most MENA countries are making considerable technical, policy, and institutional progress within their water sectors. The region manages sophisticated irrigation and drainage systems and has spearheaded advances in desalination technology. Governments are implementing innovative policies and institutional changes that show promising results. To implement the new policies, most governments established ministries that manage water resources and staffed them with well-trained and dedicated professionals. Some national governments have established agencies to plan and manage water at the river basin/aquifer level.

Some municipal governments such as in Jordan have shifted from directly providing water supply services to regulating services provided by

independent or privately owned utilities. In many countries, farmers have begun managing irrigation infrastructure and water allocations. Countries have passed new water legislation and developed strategies that are consistent with international good practice. Since the late 1990s, most countries have published official water resource management strategies. The legislative changes usually recognize the need to manage both the water resource and water service delivery aspects. Importantly, these organizational changes have put the region's freshwater resources management institutions ahead of those in other developing countries (table B.1).

Despite these many efforts, they have not led to the expected improvements in water outcomes (World Bank 2007). Water management remains a problem in most MENA countries. Water is still being allocated to low-value uses even as higher-value needs remain unmet. Service outages for water supply services are common, even in years of normal rainfall. People and economies remain vulnerable to droughts and floods. Despite the region's huge investments in piped water supply, many countries experience poor public health outcomes. Over-extraction of groundwater is undermining national assets in some countries at rates equivalent to 1–2 percent of gross domestic product (GDP) every year, and water-related environmental problems cost the region 0.5–2.5 percent of GDP every year.

**TABLE B.1**

### **Saudi Arabia's 2009 Draft National Water Strategy Promotes Far-Reaching Water Management Reforms**

Water resources	<ul style="list-style-type: none"> <li>• Adopts water-friendly agricultural policy that diverts resources away from crops that produce low economic returns compared to the high value of water; adopts a "virtual water" policy to produce crops for which Saudi Arabia has comparative advantage and import the rest</li> <li>• Establishes a system of water resource planning and management to guide allocation among various uses</li> </ul>
Governance and institutions	<ul style="list-style-type: none"> <li>• Promotes adoption of a modern water law</li> <li>• Strengthens institutions and governance through restructuring Ministry of Water and Electricity (MOWE); and initiating a capacity building program, participation of all stakeholders, and appropriate accountability and transparency mechanisms</li> <li>• Establishes local water resource management units for water planning and management</li> <li>• Ensures accountability for both service delivery and water resource management</li> </ul>
Water services	<ul style="list-style-type: none"> <li>• Shifts role of government from water service provider to regulator</li> <li>• Makes water service deliveries market oriented</li> <li>• Promotes participation of private sector in financing and providing water and sanitation services (WSS) and corporatizing government-run utilities</li> </ul>

Source: World Bank 2009.

The slow improvement rate of water outcomes in MENA persists for two reasons:

1. Changes and reform have been slow due partially to the difficulties of modifying the complex traditional socioeconomic and political factors that affect water management. The subsidy regime does not encourage growth of organizational capacity or innovation. Water organizations are unable to attract and retain staff with the range of skills required for efficient service delivery. Reliance on public budgets and on unclear accountability structures and resource and performance management systems offer poor incentives for good outcomes. Legislation often lacks the essential implementing rules and regulations, and enforcement tends to be weak. Renewed attention to these institutional issues is necessary to ensure that demand and supply management are commensurate with the challenge posed by increasing water shortages. Only determination at the highest political levels can make such a transformation.
2. Many of the important issues in water resources management, irrigation, and WSS are being tackled. Nevertheless, water allocation and use are strongly affected by agricultural, trade, and energy policies outside the water sector. The criticality of good water management to economic development in much of the region requires more integrated national approaches to policies that affect all economic activities that rely on water inputs.

The national fiscal impact of water development and management can be substantial. Governments and individuals across the region invest significant public resources in the water sector. In the MENA countries for which data are available, governments are spending 1.0–3.6 percent of GDP on the water sector (World Bank 2007). These figures, already large, exclude the significant private investment in well construction and maintenance and irrigation infrastructure, and private expenditure to pay charges on water services. In recent years, water represented 20–30 percent of government expenditures in Algeria, Egypt, and the Republic of Yemen (World Bank 2005, 2006). These large expenditures indicate why accountability and other governance structures are so important and why water investments have a strong political dimension.

## **Demand Management**

### **Agricultural Policy Reform**

In most MENA countries, food security has been a major concern, particularly for staples, such as wheat. Wheat comprises an exceptionally high 44 percent of the region's total food supply (CGIAR 2011). This

desire for food security not only has driven substantial government investment in irrigation systems but also has led to subsidies of inputs (such as pumps, irrigation technology, and electricity) and of outputs through price support mechanisms.

In the future, given the increasing populations who depend on a fixed amount of water, trade will become even more important for water management. Due to geopolitical tensions, rural employment, and food security concerns, countries will aim to increase their food self-sufficiency. At present, they achieve food security only when local production is supplemented through trade. Fortunately, most MENA countries are geographically near enough to meet European demand for off-season fruits and vegetables. If they devise progressive agricultural policies, countries could grow more of the crops that are their comparative advantage to export, while increasing imports of lower-value staples. In effect, the countries would be “exporting” high-value virtual water and “importing” larger quantities of virtual water associated with low-value commodities from countries with more abundant water supplies (Chapagain and Hoekstra 2003; Hoekstra and Hung 2002). Thus, importing staples to substitute for home-grown, low-value crops could significantly close the water gap in MENA.

Saudi Arabia is one of the most striking examples of how reforming agricultural policies can significantly reduce water demand. In the 1970s, Saudi Arabia started subsidizing wheat production, using nonrenewable groundwater. By the late 1980s, wheat production was high enough to make Saudi Arabia the world’s sixth largest exporter. Meanwhile, its crops grown using fossil water were competing in the international market against rain-fed wheat (Wichelns 2005). In 1993 the government reduced the area of wheat cultivation eligible for price support by 75 percent, saving an estimated 7.4 km<sup>3</sup> of fresh groundwater per year. Subsequently, the country’s annual agricultural water demand continued its decline from its peak of 23 km<sup>3</sup> in the mid-1990s to an estimated 14 km<sup>3</sup> in 2010. It is anticipated that, by 2014, annual groundwater demand will drop below 10 km<sup>3</sup>. Even so, irrigated fodder production that has similarly low returns to water still uses 25 percent of the groundwater resources. The United Arab Emirates had similar groundwater mining problems caused by irrigated fodder crops. In 2010, the United Arab Emirates eliminated subsidies for irrigated Rhodes grass (grown for animal feed). The government estimates this change will reduce its annual agricultural water consumption by 40 percent between April and September, the hottest months of the year (*National* 2010).

### **Improving Efficiency of Water Allocation and Use**

In dry years, due to poor intersectoral allocation and low water use efficiency, some countries do not have enough water to service export agri-

culture. For example, in dry years, Morocco, a country with superior conditions for growing olives, is obliged to import olive oil because its domestic production is not of consistently good quality and its irrigation systems are not set up to provide backup irrigation for olives. This poor management leads to dramatic drops in production during dry periods (Humpal and Jacques 2003). Thus, improving unreliable water supply through improved scheduling, management, and technology would make better use of sunk investments, which then could be used more productively.

Currently, MENA's average agricultural water use efficiency languishes at 50–60 percent. Pursued vigorously, improved scheduling, management, and technology could increase its efficiency to the level of the best managed areas of arid Australia and the United States, which have water use efficiencies higher than 80 percent.

Introduction of high-technology irrigation will save more water if it is accompanied by measures to develop protected greenhouse agriculture and agricultural extension. When all three are applied, the potential increase in water productivity (income-per-drop of water) can be large (figure B.1). Increased water productivity also is likely to increase farmers' profits using less water—a win-win outcome.

When modern technology is used effectively, on-farm water use can be reduced, and the savings could be used for other sectors. Frequently, unless there are regulatory incentives not to use water savings on farms, water saved is used to irrigate larger areas or to increase cropping inten-

**FIGURE B.1**

**High-Tech Agricultural Packages Increase Water Use Efficiency (*kg production per m<sup>3</sup> water*)**

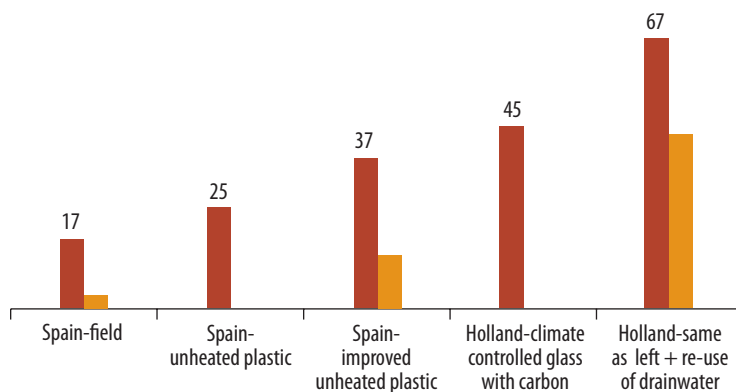

Source: ICBA 2010.

sity to increase farm incomes. For example, Tunisia's water-saving program, begun in 1990, equipped 305,000 ha, or 76 percent of all irrigated area, with water-saving technology by 2005 (Tunisia 2005).

This technology increased water use efficiency from 50 percent in 1990 to 75 percent in 2008. Although not the explicit goal of the country's water-saving program, water consumption stayed relatively constant because farmers used the saved water to expand irrigated areas or increase cropping intensity.

The drought that affected eastern Australia's Murray-Darling Basin (MDB) provides important lessons for the MENA Region in how to implement water conservation measures and how not to use saved water for additional agricultural production.<sup>2</sup> In 2007, while providing access to financing to improve irrigation efficiency, the MDB Commission also implemented buy-back of water rights from farmers with the medium-term aim of reducing water demand to align with sustainable use of renewable water supplies.<sup>3</sup> The most important lesson is that, if Australia had not had in place tradable property rights to water, the scheme would have proved impossible to implement without resorting to politically contentious, top-down reallocation of water rights. In contrast, the model adopted is a win-win system for farmers and those charged with managing water resources sustainably.

Fortunately, in most MENA countries, traditional surface water resources—perennial rivers, seasonal flood flows (*aflaj*) systems in Egypt, the Islamic Republic of Iran, Iraq, Morocco, Syria, and the Republic of Yemen—have long-established water rights. Even when these resources have been modified by large modern surface water diversions, as in Egypt, the Islamic Republic of Iran, and Iraq, new and workable systems of water rights and allocation procedures have been established successfully. However, the same cannot be said of groundwater access, which is riddled with perverse incentives that encourage unsustainable use.

### **Reducing Perverse Incentives**

In addition to affecting agricultural input and output support, perverse incentives particularly negatively affect the use of groundwater, the basis of most irrigation in the MENA Region. Groundwater generally is a common property resource accessible to all users. Groundwater is the principal water resource for Bahrain, Jordan, Kuwait, Libya, Oman, Qatar, Saudi Arabia, the United Arab Emirates, West Bank and Gaza, and the Republic of Yemen. However, the demand management challenges differ between countries with relatively high per capita incomes (the Gulf countries, Israel, and Libya) and those with lower incomes (Jordan, West

Bank and Gaza, and the Republic of Yemen). The former group can afford alternative sources of water, such as desalination, a technology usually too expensive for the latter group. The particular challenges for the lower income countries are managing groundwater extraction to avoid exhausting the resource and managing agricultural trade. As with crude oil and gas, extracting nonrenewable groundwater involves trade-offs between current and future use of the limited resource.

Almost all groundwater production for agriculture in MENA is private. Moreover, until recently, most of the initial capital investment in agricultural wells and pumping equipment was heavily subsidized by the Region's governments. As noted above, groundwater generally is free and accessible to the public, but users must bear the production cost. Even then, most agricultural users receive highly subsidized electricity (or, in the case of the Republic of Yemen, diesel fuel) to produce groundwater. Thus, operating costs tend to be very low. In addition, most electricity tariffs tend to be flat rate. Consequently, the global experience has been a "race to the bottom" as users compete to use the resource before others can. Even worse, as the resource becomes more heavily exploited, groundwater levels fall, and only those farmers able to afford the larger pumps remain in business. As a result, groundwater in the MENA Region is severely over exploited, and many smaller farmers have been marginalized. Pricing electricity at the levels equivalent to cost and thereafter by an increasing block tariff would somewhat constrain the volumes pumped.

Nevertheless, even with realistic energy pricing, the cost of groundwater production does not represent its actual value to society. Fresh groundwater is a finite resource that is being mined, and it is irreplaceable once gone. When farmers run out of fresh or moderately brackish groundwater, they typically have two choices: stop using water, or use an alternative resource. The only viable alternative source of water is desalinated water. Generally, switching to desalinated water means hooking up a small reverse osmosis (RO) plant to a well that produces salty water or tapping a desalinated water supply from one of the commercial producers. Thus, at the margin, desalinated water is the alternative to fresh groundwater. In other words, in economic terms, the opportunity cost of groundwater is the same as its substitute, desalinated water. Consequently, the marginal cost of fresh or moderately brackish groundwater is US\$1.5–2.1 per cubic meter (chapter 4), depending on the location in MENA and the desalination technology adopted.

Groundwater priced near these levels would provide a strong incentive to use fresh water efficiently and use it only on high-value crops. Some studies show that carefully thought-out pricing policies can yield substantial social benefits (Brown and Rogers 2006). In Hawaii, for example,



when the choice was between groundwater and desalination, raising the price of groundwater induced conservation such that the desalination alternative will not be needed for 90 years (Roumasset and Pitafi 2004). Without higher pricing, it would have been needed in 60 years.

In MENA, however, in practice, groundwater pricing has proved extremely difficult to implement due to the political difficulty of giving individual ownership or water rights to individuals and allowing these rights to become tradable. This task is made even more difficult by the generally poor ability to quantify groundwater resources and sustainable levels of use. The scale of individual actions to tap into groundwater also often overwhelms the ability of governments to control them, even with such approaches as licensing new wells. The Republic of Yemen is a particularly egregious example. The result is that, across the region, aquifers are being used beyond sustainable levels. Experience in MENA suggests that, in MENA, it might be easier to establish water trading institutions to obtain supplemental supplies (desalination, interbasin transfers) than it would be to reform institutional arrangements and historical property rights on a large scale (World Bank 2007). This experience could provide insights on how to adapt the market over time and scale it up to a broader application.

Groundwater conservation is an important component of reducing MENA's future water demand. Not only are the two alternatives—desalination or abandoning agriculture—very expensive but also over-pumping groundwater is depleting national assets. The economic activities based on the extracted water may increase GDP in the short term, but over-extraction undermines a country's natural capital or wealth in the longer term. Calculations based on available data for four MENA countries (World Bank 2007) show that the annual value of national wealth consumed by over-extraction of groundwater can be as much as the equivalent of 2 percent of GDP (figure B.2).

### **Managing Domestic Demand**

Managing domestic water demand entails primarily reducing water loss on the supply side and reducing excessive consumption on the demand side. Only a small portion of MENA's population—in Saudi Arabia and the Gulf states—has the luxury of purchasing almost unlimited water supply. For this reason, the main regional emphasis of demand management will be to reduce losses, often called nonrevenue water.<sup>4</sup> Reducing non-revenue water is important because consumers are paying for water utilities' inefficiencies, the waste of a precious and scarce resource, and unnecessary investments in production.

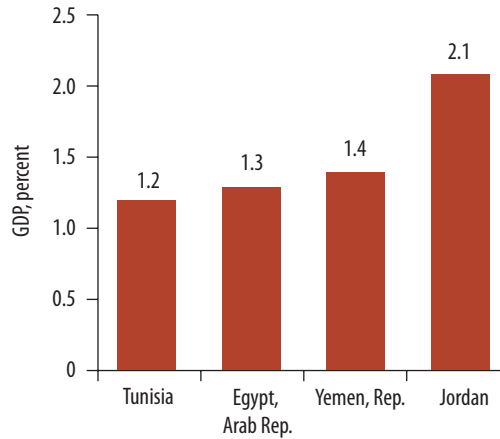
**FIGURE B.2****Value of Groundwater Depletion in Selected MENA Countries as Share of GDP**

Source: World Bank 2007 after Ruta 2005.

Most government-managed water supply utilities in MENA have water losses in excess of 30 percent (figure B.3). In comparison, international best practice for a well-managed utility is approximately 10 percent water loss (World Bank 2007). Thus, on the basis of MENA's domestic water demand in 2010 of 28 km<sup>3</sup>, water resources demand could be reduced by as much as 5.6 km<sup>3</sup> a year if nonrevenue water could be reduced to best-practice levels.

Per capita water consumption for domestic uses could be substantially reduced if the appropriate incentive structures were introduced. International experience is that, after physical improvements (such as reducing leaks and installing more efficient plumbing appliances), administrative and pricing instruments are the most effective means to reduce wasteful household consumption. These instruments have conserved water in Australia, Canada, England, and Wales. Most of their populations live in nondesert climates; the water tariffs are near the cost of producing and distributing potable water; and the billing, collection, and disconnection policies are robust.

To achieve these savings, demand management in MENA will have to focus on three factors:

1. Upgrading water distribution systems to reduce leakage
2. Improving customer registration and billing
3. Finding the revenues to pay for the first two factors, including reforming tariffs.

FIGURE B.3

Nonrevenue Water Rates for Utilities in Selected MENA Countries and Cities

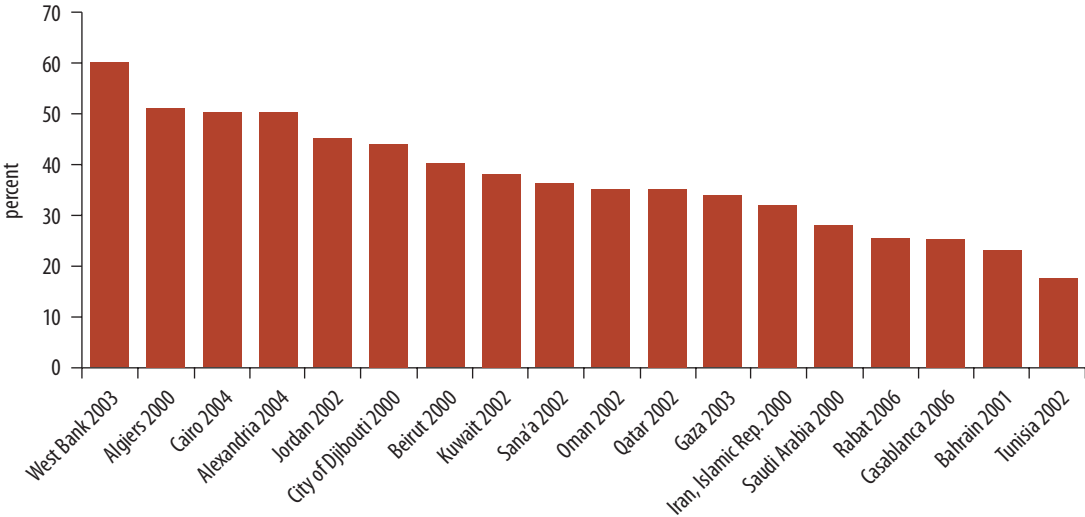

Source: World Bank 2007.

Many MENA governments still are the primary service providers so have few incentives to conserve water. Worse, due to low water tariffs, they frequently have insufficient revenues to properly maintain and operate the water distribution systems, exacerbating nonrevenue water losses. The Asian Development Bank (ADB) has come up with guidelines on the most effective measures to reduce nonrevenue water (box B.1).

Several MENA countries have had some success in reducing non-revenue water. Generally, this success has involved contracting a private utility operator to manage the water supply. The experience has been a quadruple win: for the government, the consumer, the private sector, and for water conservation.

In Jordan, a management contract with a private firm is increasing water system efficiency in Amman. The private company (LEMA) is responsible for providing water, providing customer service, responding to complaints, and maintaining the tertiary network. LEMA does not set prices but is empowered to discontinue service to nonpaying customers. The company has delivered positive results. It now covers 125 percent of its operations and maintenance (O&M) costs, in contrast to public-owned utilities in other cities, which cover a far lower share. Service improved, from 32 h per week before the contract to 40–45 h per week in 2003. Although improvement has been slower than expected, LEMA reduced unaccounted-for water from 55 percent in 1999 to 43 percent in 2004. Customer satisfaction has increased.

**BOX B.1****Priorities for Reducing Nonrevenue Water**

- Governance and tariffs must be tackled first.
- Leak detection equipment comes last, not first.
- Repair visible leaks.
- Make utility staff responsible for small zones (caretakers).
- Properly meter all production and consumption.
- Add district metering.
- Provide incentives for utility staff's good performance.
- Explore links to water vendors.

Source: McIntosh 2003.

In Morocco, concession of water supply and sanitation services to the private sector in four large cities incentivized improved performance (Bouhamidi 2005). The government regulates the concessions through the Delegating Authority, which determines tariff caps, service standards, priority projects, and investment obligations. The contracts stipulate investments of almost US\$4 billion over 30 years. Rules and guidelines for adjusting tariffs are flexible. In Rabat, Tangiers, and Tetouan, a price cap requires that any tariff increase of more than 3 percent be made in agreement with the municipal government. The government also retains the ability to make unilateral changes to tariffs for “reasons of public interest” so long as the government compensates the private operators for any losses.

These rules on tariff adjustment, coupled with the fact that the contracts enable private operators to keep a large share of their profits, provide incentives for the private operators to control costs and improve efficiency, to the benefit of the customers. The investments as well as operational improvements have improved service. Water is now available 24 h a day in these four cities, and water supply connections have increased by almost 33 percent since the concession began. Between 1997 and 2001, private investments in sanitation alone amounted to €97 million (US\$94 million).<sup>5</sup> Since 1997, a combination of tariffs that increased threefold, introduction of a sanitation charge, and reducing leakage has reduced demand by an average of 3 percent per year. As a result, demand projections are lower than previously estimated, reducing the need for dam construction and saving the government some US\$450 million in new investment.

## Conventional Supply Management Options Are Limited

Rainwater harvesting and check dams in *wadis* generally are very small scale and very local in application.<sup>6</sup> Typically, they provide drinking water and groundwater recharge to single households or small communities. From a regional perspective, these two sources can only slightly augment supply, except in rural areas.

Building dams to impound larger volumes of water has limited potential in the MENA Region. Rivers in the region are the most heavily dammed in the world in relation to the freshwater available. More than 80 percent of the region's surface freshwater resources already are stored behind reservoirs (World Bank 2007). However, some potential exists, particularly in the more humid parts of the region such as northwestern Islamic Republic of Iran and the Atlas Mountains in Algeria and Morocco. Elsewhere, in the more arid countries of MENA, the highly uncertain rainfall amounts and frequency frustrate reliance on reservoirs for assured supplies, a situation worsened by the likelihood of lower precipitation in the future.

Wastewater reuse, including irrigation water reuse and desalination of brackish groundwater and seawater hold significant potential to bridge MENA's water demand gap. Some countries in MENA have significantly large brackish groundwater reserves. They could be used to support salt-tolerant agriculture and/or be a source of desalinated water. Recycled wastewater is an assured resource and the only one that is guaranteed to increase in response to population growth. Finally, desalinated seawater (or brackish water) is available near most of MENA's population centers. The constraints are its relatively high cost and dependence on high energy inputs. The following sections briefly discuss potential groundwater supplies and the opportunities to utilize recycled water.

### Groundwater

Groundwater in the MENA Region is poorly managed. In many cases, as extractions exceed recharge, it is being permanently depleted. In the medium to long term, the expectation is that most MENA countries will exhaust this water resource. Consequently, fossil groundwater normally is not considered a future supply option. The exceptions would be as a strategic reserve to bridge the seasonal and annual variability of renewable water resources or in the event of breakdown of alternative supply options such as desalination. Such exceptions need not be the case if more attention were given to water quality. Although fresh groundwater reserves are in a critical state, the same is not true of brackish groundwater.

Potentially, brackish groundwater reserves in MENA are large. Regarding desalination, unit costs of desalinated groundwater are likely to be approximately half (or less) of the cost of desalinating seawater—the only alternative to groundwater in most MENA countries.

As noted above, knowledge of the distribution of groundwater quantity and its quality is poor in MENA, with the exception of the countries in the Arabian Peninsula. In the United Arab Emirates, for example, brackish groundwater reserves are significantly large (Map B.1). When they are taken into account, long-term reliance on treated groundwater would be a far cheaper option than desalinating seawater. The United Arab Emirates uses its groundwater primarily for agriculture or forestry. The national groundwater volume is huge, but only 3 percent of the water available (approximately 20 km<sup>3</sup>) is fresh. In contrast, almost 40 percent is slightly brackish and could be used after desalination. Circumstances are likely to be similar in some other MENA countries. To plan for the orderly use of brackish groundwater and its desalination, most countries will need to undertake more extensive and intensive groundwater surveys.

### Recycling Wastewater

Wastewater is the only potential renewable water resource in MENA that will increase naturally over time. This increase will be driven by (1) popu-

#### MAP B.1

### United Arab Emirates Groundwater Resources Are Large but Mostly Brackish

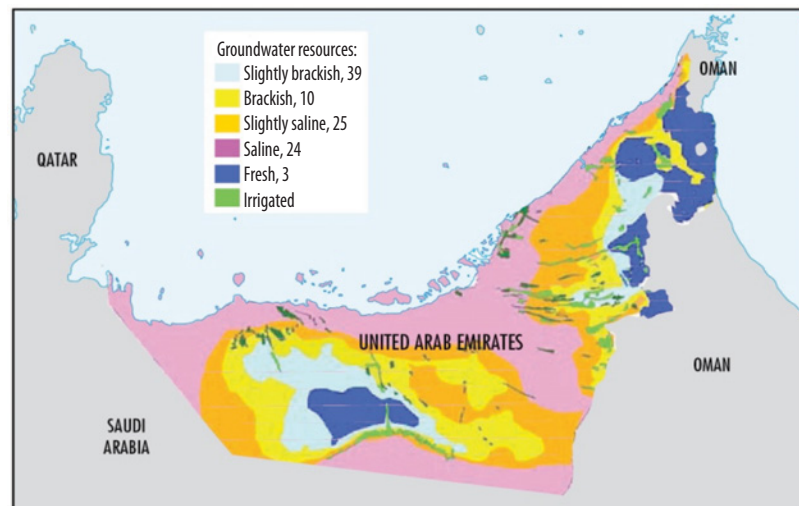

Source: United Arab Emirates 2010.

lation growth, (2) the extension of wastewater collection and treatment networks, and (3) peoples' acceptance of its use. Given that actual consumption of water by drinking, cooking, and washing accounts for approximately only 10 percent of domestic demand, the potential is large. If only 50 percent of this potential wastewater were recycled, it could add approximately 22 km<sup>3</sup> a year to MENA's renewable water resources by 2030, and as much as 40 km<sup>3</sup> a year by 2050.

Globally, many countries have recognized the benefits of water reclamation and reuse through legislative and policy frameworks. In the European Union (EU), water reclamation and reuse in member countries are guided by the EU Water Framework Directive (2000).<sup>7</sup> In 2006 the World Health Organization (WHO) updated its global guidelines for the use of wastewater in agriculture.

Most of the significant developments in water reclamation and reuse have occurred in the arid regions of the world, which include Australia and the Mediterranean region as well as the western and southwestern United States. In the Mediterranean region, Greece, Spain, and the southern provinces of France and Italy have been the vanguards of water reclamation and reuse. Portugal and Tunisia also have well-established agricultural and landscape irrigation programs that use reclaimed water. However, in MENA, only a few countries—Israel, Jordan, Oman, Tunisia, and the United Arab Emirates among them—have explicitly included water reuse in their water resources planning and have official policies calling for water reuse.

The majority of global water reuse is for nonpotable applications, such as agricultural and landscape irrigation and industrial recycling and reuse. Indeed, reclaimed water long has been recognized as a valuable resource for use in irrigation (UNDP and others 1992). It is applied through different irrigation systems depending on, among other conditions, the crop to be irrigated. Kuwait and Tunisia provide good examples of current practice (box B.2).

### **Recycled Water: Lessons Learned**

Building public acceptance is essential. The success of water reuse depends in part on public approval. International experience suggests that the public often accepts the use of reclaimed water to irrigate recreational areas or to recharge groundwater. However, reuse in agriculture tends to raise concerns. The public also holds strong views about which type of organization is better able to manage treated wastewater. In Australia for example, health departments were the most trusted, followed by the water agency and Department of Environment. Private companies and local governments were the least trusted. Public trust concerned not only man-

**BOX B.2****Recycled Water Is a Valuable Resource: Examples from Kuwait and Tunisia****Kuwait**

For the past few decades, Kuwait has practiced water reclamation and reuse to extend its limited natural water supply. During 2000–10, the country's annual quantity of wastewater produced ranged from 206 to 254 Mm<sup>3</sup>. The Ministry of Public Works established strict effluent quality standards for water reuse. Irrigation of food crops eaten raw requires tertiary treatment, with strict water quality limits. Most reclaimed water is used for agricultural irrigation. Some of this water is used to grow vegetables in soil-less aquaponic growing systems in greenhouses. In 1997 reclaimed water irrigated 4,470 ha of agricultural land, or 25 percent of Kuwait's total irrigated area. Reclaimed water irrigates 1,680 ha of afforestation projects in the country, and the plans are to expand this to 3,300 ha. In urban areas, the use of reclaimed water for landscape irrigation is growing, particularly for trees and the development of green areas. A small amount goes to recharge groundwater via surface percolation basins. Some industrial wastewater also is recycled after treatment.

**Tunisia**

Tunisia has long experience (since 1965) in using treated wastewater to irrigate the citrus orchards and olive trees of the Soukra irrigation scheme (8 km northeast of Tunis), which covers 600 ha (Bahri 2008). In 2008 Tunisia's 61 wastewater treatment plants collected 240 MCM of wastewater. Less than 30 percent of it was reused to irrigate vineyards, citrus, trees (olives, peaches, pears, apples, pomegranates), fodder crops (alfalfa, sorghum), industrial crops (cotton, tobacco), cereals, and golf courses in Tunis, Hammamet, Sousse, and Monastir. The wastewater effluent is treated to secondary levels, and farmers pay subsidized prices for the treated wastewater they use to irrigate their fields (Bahri 2008).

agement institutions but also timely information management and dissemination.

Participants generally trusted agencies such as the state and local health departments, medical doctors, environmental groups, the Department of Environment, and the state Water Corporation to provide infor-

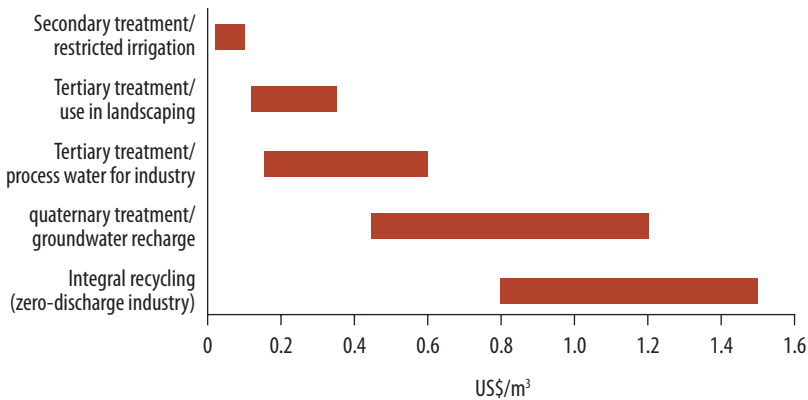

**FIGURE B.4****Cost Range for Water Reuse**

Source: Adapted from Labre 2009.

Note: Excludes water distribution costs.

mation. Private companies were rated significantly lower than the other groups across both surveys.

Consumers are very sensitive to the terminology used to describe recycled wastewater. Surveys show that the less offensive terms were “recycled water” and “purified water.” “Reclaimed wastewater” was the least popular (Po, Kaercher, and Nancarrow 2004; Po and Nancarrow 2004).

Various protocols and technologies are available to treat wastewater. It is important for treatment strategies to take into account the effluent quality criteria required by different reuse applications, because these criteria are the major determinants of the costs (figure B.4). Cost also will be increased by the need for distribution systems. Many MENA countries require that recycled water be kept separate from potable water distribution systems. When recycled water is used for urban landscaping, distribution costs can be reduced. Cost probably would not be reduced for recycled water for agriculture, which could require transmission over considerable distances.

**Notes**

1. Assuming ET of 10 mm per day, this amount equates to 100,000 m<sup>3</sup> per day. However, since water use efficiency is only 50 percent, the required volume is 200,000 m<sup>3</sup> per day. If the average domestic consumer uses 100 liters per day, the demand equates to the total demand of 2 million people.
2. <http://www.environment.gov.au/water/policy-programs/entitlement-purchasing/index.html>.

3. Water Act 2007, or Australian Government. Act No. 137 of 2007 (amended). The Act provided for the management of the water resources of the MDB and for other matters of national interest in relation to water and water information, and related purposes.
4. “Losses” in this context also are called “nonrevenue water” or “unaccounted-for-water.” All three terminologies include physical losses from leaky pipes, losses due to unauthorized tapping of water pipelines, and losses due to unbilled water that may or may not be metered.
5. Based on the average 1997–2001 exchange rate.
6. A *wadi* is a dry valley, gully, or streambed. During the rainy season, the same name is given to the stream that runs through the *wadi*.
7. Nine years earlier, the European Communities Commission Directive (91/271/EEC) had specified that “treated wastewater shall be reused whenever appropriate” and that “disposal routes shall minimize the adverse effects on the environment.” European Commission’s Council (EEC 1991). Urban Wastewater Directive, May 21, 1991. 91/271/EC. [http://ec.europa.eu/environment/water/water-urbanwaste/index\\_en.html](http://ec.europa.eu/environment/water/water-urbanwaste/index_en.html).

## References

- Bahri, A. 2008. “Case Studies in Middle Eastern and North African countries.” In *Water Reuse: An International Survey of Current Practice, Issues and Needs*, ed. B. Jimenez and T. Asano, 558–92. London: IWA (International Water Association).
- Bouhamidi, R. 2005. “Morocco Water Concessions Case Study.” Background paper to *Making the Most of Scarcity: Accountability for Better Water Management Results in the Middle East and North Africa*, World Bank, Washington, DC.
- Brown, C., and P. Rogers. 2006. “Effect of Forecast-Based Pricing on Irrigated Agriculture: A Simulation.” *ASCE Journal of Water Resources Planning and Management* 122 (6) : 403–13.
- CEDARE (Center for Environment and Development for the Arab Region and Europe). 2005. *Status of Integrated Water Resource Management (IWRM) Plans in the Arab Region*. Review undertaken by CEDARE in its capacity as AWC (Arab Water Council) Interim Technical Secretariat in cooperation with UNDP (United Nations Development Program), Cairo. <http://water.cedare.int/cedare.int/files15%5CFile2298.pdf>.
- CGIAR (Consultative Group on International Agricultural Research). 2011. “Research and Impact: Areas of Research: Wheat.” CGIAR, Washington DC. <http://www.cgiar.org/impact/research/wheat.html>.
- Chapagain, A. K., and A. Y. Hoekstra. 2003. *Virtual Water Flows between Nations in Relation to Trade in Livestock and Livestock Products*. Value of Water Research Report Series 13, UNESCO-IHE (Institute for Water Education), Delft, the Netherlands. <http://www.unesco-ihe.org/Project-Activities/Project-Portfolio/Virtual-Water-Trade-Research-Programme>.
- Hoekstra, A. Y., and P. Q. Hung. 2002. “Virtual Water Trade: A Quantification of Virtual Water Flows between Nations in Relation to International Crop Trade.” Value of Water Research Report Series 11, UNESCO-IHE Institute for Water Education, Delft, the Netherlands. <http://www.unesco-ihe.org/>

- Project-activities/Project-Portfolio/Virtual-Water-Trade-Research-Programme/Hoekstra-A.Y.-Hung-P.Q.-2002.-Virtual-water-trade-A-quantification-of-virtual-water-flows-between-nations-in-relation-to-international-crop-trade-Value-of-Water-Research-Series-No.-11-UNESCO-IHE.
- Humpal, D., and K. Jacques. 2003. *Draft Report on Bumpers and Import Sensitivity Analysis for Moroccan Table Olives and Olive Oil*. Prepared for USAID (United States Agency for International Development) under the Raise Sanitary and Phytosanitary Services (SPS) contract with financing from the Middle East Partnership Initiative (MEPI). [http://pdf.usaid.gov/pdf\\_docs/PNACX907.pdf](http://pdf.usaid.gov/pdf_docs/PNACX907.pdf).
- McIntosh, A. C. 2003. "Asian Water Supplies: Reaching the Urban Poor." Asian Development Bank, International Water Association. [http://www.adb.org/documents/books/asian\\_water\\_supplies/chapter09.pdf](http://www.adb.org/documents/books/asian_water_supplies/chapter09.pdf).
- National. 2010. "End to Subsidy for Farmers' Rhodes Grass." Abu Dhabi. September 28. <http://www.thenational.ae/news/uae-news/environment/end-to-subsidy-for-farmers-rhodes-grass>.
- Po, M., J. D. Kaercher, and B. E. Nancarrow. 2004. *Literature Review of Factors Influencing Public Perceptions of Water Reuse*. Land and Water, Australian Water Conservation and Reuse Research Program, CSIRO (Commonwealth Scientific and Industrial Research Organisation), Perth. <http://www.clw.csiro.au/publications/technical2003/tr54-03.pdf>.
- Po, M., and B. E. Nancarrow. 2004. *Consumer Perceptions of the Use of Reclaimed Water for Horticultural Irrigation: A Literature Review for Land and Water Australia*. Land and Water Consultancy Report. Perth, Australia: CSIRO (Commonwealth Scientific and Industrial Research Organisation).
- Roumasset, J. A., and B. A. K. Pitafi, 2004. *Watershed Conservation and Efficient Groundwater Pricing*. 2004 Annual meeting, August 1–4, Denver, CO: Agricultural and Applied Economics Association.
- Tunisia, Republic of (République Tunisienne). 2005. *Rapport d'avancement du PISEAU*. Tunis: MAERH (Ministry of Agriculture, Environment and Water Resources).
- Tunisia, Republic of (République Tunisienne). 2006. "Ministry of Agriculture and Hydraulic Resources." Presentation to a Seminar on Integrated Water Resources Management, Rabat, Morocco, January.
- United Arab Emirates. 2010. *United Arab Emirates Water Conservation Strategy*. Dubai: Ministry of Environment and Water.
- UNDP (United Nations Development Programme), FAO (Food and Agriculture Organization of the United Nations), World Bank, and WHO (World Health Organization). 1992. *Wastewater Treatment and Reuse in the Middle East and North Africa Region: Unlocking the Potential*. Report of a Joint Mission to Cyprus, Egypt, Jordan, Kuwait, Morocco, Saudi Arabia, Syria, Tunisia, Turkey and Yemen. Review Draft. Project RAB/88/009. Washington, DC.
- Wichelns, D. 2005. "The Virtual Water Metaphor Enhances Policy Discussions Regarding Scarce Resources." *Water International* 30 (4): 428–37.
- World Bank. 2005. *Republic of Yemen: Country Water Resource Assistance Strategy*. Report 31779-YEM, Washington, DC: World Bank.

- . 2006. *People's Democratic Republic of Algeria, Making Best Use of the Oil Windfall with High Standards for Public Investment. A Public Expenditure Review*. Draft Report 36270–DZ, Washington, DC: World Bank.
- . 2007. *Making the Most of Scarcity: Accountability for Better Water Management Results in the Middle East and North Africa*. MENA Development Report, Washington, DC. [http://siteresources.worldbank.org/INTMENA/Resources/Water\\_Scarcity\\_Full.pdf](http://siteresources.worldbank.org/INTMENA/Resources/Water_Scarcity_Full.pdf).
- . 2009. *Draft Water Strategy for the Kingdom of Saudi Arabia*. Washington, DC: World Bank.

# The True Cost of Desalination

The cost of desalination is highly site specific. Feed water temperature and salinity, inlet and outlet hydraulic characteristics and associated environmental mitigations required, desalination technology, and energy source are the major factors that dictate the cost of desalination.

In terms of *conventional energy cost*, cost of electricity depends on power plant portfolio within the supply area (country) and on fuel cost. However, for the sake of simplicity, in this volume, the energy costs of two countries were used as representative of the whole MENA Region. The energy cost for Morocco was used as representative of North Africa; Saudi Arabia's was used to represent countries in the Middle East. Similarly, many MENA countries hugely subsidize energy costs (tables C.1 and C.2). In this volume, *the unsubsidized energy cost* has been adopted to compute the true cost of desalination.

Nonsubsidized electricity cost is calculated based on the opportunity cost of fuel used to generate electricity. In this volume, the cost of a barrel

**TABLE C.1**

## Subsidized Electricity Costs: Morocco and Saudi Arabia

Country	Subsidized electricity price (US\$/kWh)
Morocco, as representative of North African countries	0.079
Saudi Arabia, as representative of Middle East countries	0.041

Source: Fichtner and DLR 2011.

**TABLE C.2**

## Nonsubsidized Energy Cost

Power generation type/model	Nonsubsidized electricity cost (US\$/kWh)
Combined cycle power plant (CCPP)	0.115
Heavy fuel oil steam turbine power plant (HFO ST PP)	0.150

Source: Fichtner and DLR 2011.

**TABLE C.3**

**Subsidized and Nonsubsidized Steam Price**

Country	Subsidized steam price (US\$/tons of steam)
Morocco, used as representative of North African countries	5.0
Saudi Arabia, used as representative of Middle East countries	2.6
	Nonsubsidized steam cost (US\$/tons of steam)
<i>Power generation type/model</i>	
Combined cycle power plant (CCPP)	7.3
Heavy fuel oil steam turbine power plant (HFO ST PP)	9.5

Source: Fichtner and DLR 2011.

of crude was assumed at US\$110, which corresponds roughly to 64.9 US\$ per MWh<sub>th</sub>. Based on this assumption, the nonsubsidized electricity price is indicated in table C.2.

Nonsubsidized steam cost is calculated based on equivalent electricity. This volume assumed a 0.063 kWh of electricity per kilogram of steam for electricity-to-heat-ratio of extracted steam. Based on the foregoing assumption, the subsidized and nonsubsidized steam costs assumed in this volume are indicated above (table C.3).<sup>1</sup>

An additional assumption adopted in this volume includes that the escalation of the electricity price is proportional to the escalation cost of fossil fuel.

In terms of *renewable energy (RE) cost*, the analysis in this volume depends on hybrid renewable energy with a fossil fuel backup, except under one scenario (solar-only scenario<sup>2</sup>). Due to its current high cost, pure RE desalination has not been assumed until after 2030, when it is assumed that the cost of RE will be competitive. Until then, a solar multiple 2 (SM2) solar share ranging between 46 and 54 percent, based on DNI, is assumed. The breakdown of investment cost and annualized/levelized energy cost (LEC) for various combinations of RE and backup fossil-fuel based energy is provided in tables C.4 and C.5. As indicated above, the energy requirement of desalination processes depend on the quality of feedwater. As such, this volume analyzed energy cost by categorizing waterbodies in MENA into three main zones: the Mediterranean and Atlantic Ocean water, the Red Sea and Indian Ocean water, and the Gulf water.

To determine the *true cost of water*, the analysis in this volume is based on the combination of capital investment costs (CAPEX) and operational costs (OPEX) of which energy cost assumes the lion’s share (tables C.6 and C.7). From the analysis, the costs vary by feedwater quality, RE-desalination technology configurations adopted, and fuel cost.

TABLE C.4

## Preliminary Analysis Results: Investment Cost Breakdown and LEC, Heavy Fuel Oil

	Unit	CSP/MED			CSP/RO + Once-Through Cooling			CSP/RO + Dry Cooling			CSP/RO + Dry Cooling + Solar Only		
		Mediterranean Sea	Red Sea	Arabian Gulf	Mediterranean Sea	Red Sea	Arabian Gulf	Mediterranean Sea	Red Sea	Arabian Gulf	Mediterranean Sea	Red Sea	Arabian Gulf
Location	—	Coast						Inland					
DNI	kWh/(m <sup>2</sup> ·year)	2,000						2,400					
SM	—	2											
Seawater design temperature	°C	25	30	35	25	30	35	25	30	35	25	30	35
Seawater design salinity	ppm	39,000	43,000	46,000	39,000	43,000	46,000	39,000	43,000	46,000	39,000	43,000	46,000
Desalination capacity	m <sup>3</sup> /day	100,000											
Fossil fuel	—	HFO						—					
Auxiliary power desalination	kWh/m <sup>3</sup>	1.55						3.50					
Gross turbine efficiency	%	32.9			38.5	37.7	37.0				34.9		
Gross power production	MW	107.8			116.0	117.5	120.0				116.6		
Net power production	MW	90.0											
Internal power consumption	MW	17.8			26.0	27.5	30.0				26.7		
Thermal flow solar field	MW	654			603	623	648				668		
Mirror area	km <sup>2</sup>	1.26			1.16	1.20	1.25				1.28		
Land use	km <sup>2</sup>	4.78			4.41	4.55	4.73				4.88		
Energy storage capacity	MWh	2,504			2,308	2,383	2,479				2,555		
Solar full load hours	h/year	3,105						3,778					
Total full load hours	h/year	8,000						3,778					
Solar share	%	38.8%						47.2%					
Total net power production	GWh el/year	719.8						339.9					
Total water production	Million m <sup>3</sup> /year	33.3											
Total investment cost	Million US\$	1226.1			1106.3	1128.0	1183.0	1203.0	1213.1	1256.0	1159.8	1169.4	1211.6
Total investment CSP + PB	Million US\$	912.5			891.0	912.7	941.5	987.7	997.8	1014.5	944.5	954.1	970.1
Investment on solar field	Million US\$	520.5			482.9	497.3	515.8	530.3	535.9	545.3	530.3	535.9	545.3
Investment on thermal storage	Million US\$	189.1			175.8	180.9	187.5	192.6	194.6	198.0	192.6	194.6	198.0
Investment on back-up boiler	Million US\$	40.0			43.4	43.8	44.5	43.2	43.6	44.4	0.0	0.0	0.0
Investment on power block	Million US\$	162.9			172.1	173.8	176.5	172.9	174.4	177.0	172.9	174.4	177.0
Investment on cooling	Million US\$	0.0			16.8	16.9	17.2	48.7	49.1	49.9	48.7	49.1	49.9
LEC	US\$cent/kWh	22.59	22.95	23.33	21.97	22.32	22.68	22.66	22.64	22.60	24.68	24.64	24.57

(Table continues next page)

TABLE C.4

continued

	Unit	CSP/MED			CSP/RO + Once-Through Cooling			CSP/RO + Dry Cooling			CSP/RO + Dry Cooling + Solar Only		
		Mediterranean Sea	Red Sea	Arabian Gulf	Mediterranean Sea	Red Sea	Arabian Gulf	Mediterranean Sea	Red Sea	Arabian Gulf	Mediterranean Sea	Red Sea	Arabian Gulf
Location	—	Coast						Inland					
DNI	kWh/(m <sup>2</sup> year)	2,400						2,800					
SM	—	2											
Seawater design temperature	°C	25	30	35	25	30	35	25	30	35	25	30	35
Seawater design salinity	ppm	39,000	43,000	46,000	39,000	43,000	46,000	39,000	43,000	46,000	39,000	43,000	46,000
Desalination capacity	m <sup>3</sup> /day	100,000											
Fossil fuel	—	HFO						—					
Auxiliary power desalination	kWh/m <sup>3</sup>	1.55			3.50								
Gross turbine efficiency	%	32.9			38.5	37.7	37.0	34.9					
Gross power production	MW	107.8			116.0	117.5	120.0	116.6					
Net power production	MW	90.0											
Internal power consumption	MW	17.8			26.0	27.5	30.0	26.7					
Thermal flow solar field	MW	654			603	623	648	668					
Mirror area	km <sup>2</sup>	1.26			1.16	1.20	1.25	1.28					
Land use	km <sup>2</sup>	4.78			4.41	4.55	4.73	4.88					
Energy storage capacity	MWh	2,504			2,308	2,383	2,479	2,555					
Solar full load hours	h/year	3,652			4,344								
Total full load hours	h/year	8,000			3,778								
Solar share	%	45.7%			54.3%			100.0%					
Total net power production	GWh el/year	719.8			390.8								
Total water production	Millions m <sup>3</sup> /year	33.3											
Total investment cost	Millions US\$	1226.1			1106.3	1128.0	1183.0	1203.0	1213.1	1256.0	1159.8	1169.4	1211.6
Total investment CSP + PB	Millions US\$	912.5			891.0	912.7	941.5	987.7	997.8	1014.5	944.5	954.1	970.1
Investment on solar field	Millions US\$	520.5			482.9	497.3	515.8	530.3	535.9	545.3	530.3	535.9	545.3
Investment on thermal storage	Millions US\$	189.1			175.8	180.9	187.5	192.6	194.6	198.0	192.6	194.6	198.0
Investment on back-up boiler	Millions US\$	40.0			43.4	43.8	44.5	43.2	43.6	44.4	0.0	0.0	0.0
Investment on power block	Millions US\$	162.9			172.1	173.8	176.5	172.9	174.4	177.0	172.9	174.4	177.0
Investment on cooling	Millions US\$	0.0			16.8	16.9	17.2	48.7	49.1	49.9	48.7	49.1	49.9
LEC	US\$cent/kWh	21.33	21.68	22.03	20.74	21.07	21.40	21.26	21.23	21.19	21.47	21.43	21.37

Source: Fichtner and DLR 2011.

Note: Assumptions: DNI Coast: 2,400 kWh per m<sup>2</sup> per year; DNI inland: 2,800 kWh per m<sup>2</sup> per year; backup fuel: Heavy fuel oil.



**TABLE C.5**

**Preliminary Analysis Results: Investment Cost Breakdown and LEC, Natural Gas**

	Unit	CSP/MED			CSP/RO + Once-Through Cooling			CSP/RO + Dry Cooling			CSP/RO + Dry Cooling + Solar Only		
		Mediterranean Sea	Red Sea	Arabian Gulf	Mediterranean Sea	Red Sea	Arabian Gulf	Mediterranean Sea	Red Sea	Arabian Gulf	Mediterranean Sea	Red Sea	Arabian Gulf
Location	—	Coast						Inland					
DNI	kWh/(m <sup>2</sup> year)	2,000						2,400					
SM	—							2					
Seawater design temperature	°C	25	30	35	25	30	35	25	30	35	25	30	35
Seawater design salinity	ppm	39,000	43,000	46,000	39,000	43,000	46,000	39,000	43,000	46,000	39,000	43,000	46,000
Desalination capacity	m <sup>3</sup> /day							100,000					
Fossil fuel	—							NG			—		
Auxiliary power desalination	kWh/m <sup>3</sup>	1.55									3.50		
Gross turbine efficiency	%	32.9			38.5	37.7	37.0				34.9		
Gross power production	MW	107.8			116.0	117.5	120.0				116.6		
Net power production	MW							90.0					
Internal power consumption	MW	17.8			26.0	27.5	30.0				26.7		
Thermal flow solar field	MW	654			603	623	648				668		
Mirror area	km <sup>2</sup>	1.26			1.16	1.20	1.25				1.28		
Land use	km <sup>2</sup>	4.78			4.41	4.55	4.73				4.88		
Energy storage capacity	MWh	2,504			2,308	2,383	2,479				2,555		
Solar full load hours	h/year	3,105			3,105	3,105	3,105				3,778		
Total full load hours	h/year							8,000					
Solar share	%	38.8%						47.2%			100.0%		
Total net power production	GWh el/year							719.8			339.9		
Total water production	Millions m <sup>3</sup> /year							33.3					
Total investment cost	Millions US\$	1226.1			1106.3	1128.0	1183.0	1203.0	1213.1	1256.0	1159.8	1169.4	1211.6
Total investment CSP + PB	Millions US\$	912.5			891.0	912.7	941.5	987.7	997.8	1014.5	944.5	954.1	970.1
Investment on solar field	Millions US\$	520.5			482.9	497.3	515.8	530.3	535.9	545.3	530.3	535.9	545.3
Investment on thermal storage	Millions US\$	189.1			175.8	180.9	187.5	192.6	194.6	198.0	192.6	194.6	198.0
Investment on back-up boiler	Millions US\$	40.0			43.4	43.8	44.5	43.2	43.6	44.4	0.0	0.0	0.0
Investment on power block	Millions US\$	162.9			172.1	173.8	176.5	172.9	174.4	177.0	172.9	174.4	177.0
Investment on cooling	Millions US\$	0.0			16.8	16.9	17.2	48.7	49.1	49.9	48.7	49.1	49.9
LEC	US\$cent/kWh	23.29	23.67	24.06	22.65	23.02	23.39	23.32	23.29	23.25	24.68	24.64	24.57

(Table continues next page)

TABLE C.5

*continued*

	Unit	CSP/MED			CSP/RO + Once-Through Cooling			CSP/RO + Dry Cooling			CSP/RO + Dry Cooling + Solar Only		
		Mediterranean Sea	Red Sea	Arabian Gulf	Mediterranean Sea	Red Sea	Arabian Gulf	Mediterranean Sea	Red Sea	Arabian Gulf	Mediterranean Sea	Red Sea	Arabian Gulf
Location	—	Coast						Inland					
DNI	kWh/(m <sup>2</sup> year)	2,400						2,800					
SM	—	2											
Seawater design temperature	°C	25	30	35	25	30	35	25	30	35	25	30	35
Seawater design salinity	ppm	39,000	43,000	46,000	39,000	43,000	46,000	39,000	43,000	46,000	39,000	43,000	46,000
Desalination capacity	m <sup>3</sup> /day	100,000											
Fossil fuel	—	NG						—					
Auxiliary power desalination	kWh/m <sup>3</sup>	1.55						3.50					
Gross turbine efficiency	%	32.9			38.5			37.7			37.0		
Gross power production	MW	107.8			116.0			117.5			120.0		
Net power production	MW	90.0											
Internal power consumption	MW	17.8			26.0			27.5			30.0		
Thermal flow solar field	MW	654			603			623			648		
Mirror area	km <sup>2</sup>	1.26			1.16			1.20			1.25		
Land use	km <sup>2</sup>	4.78			4.41			4.55			4.73		
Energy storage capacity	MWh	2,504			2,308			2,383			2,479		
Solar full load hours	h/year	3,652			3,652			3,652			3,652		
Total full load hours	h/year	8,000						4,344					
Solar share	%	45.7%						54.3%					
Total net power production	GWh el/year	719.8						390.8					
Total water production	Millions m <sup>3</sup> /year	33.3											
Total investment cost	Millions US\$	1226.1			1106.3			1128.0			1183.0		
Total investment CSP + PB	Millions US\$	912.5			891.0			912.7			941.5		
Investment on solar field	Millions US\$	520.5			482.9			497.3			515.8		
Investment on thermal storage	Millions US\$	189.1			175.8			180.9			187.5		
Investment on back-up boiler	Millions US\$	40.0			43.4			43.8			44.5		
Investment on power block	Millions US\$	162.9			172.1			173.8			176.5		
Investment on cooling	Millions US\$	0.0			16.8			16.9			17.2		
LEC	US\$cent/kWh	21.96	22.31	22.68	21.35	21.69	22.04	21.83	21.80	21.76	21.47	21.43	21.37

Source: Fichtner and DLR 2011.

Note: Assumptions: DNI Coast: 2,400 kWh per m<sup>2</sup> per year; DNI inland: 2,800 kWh per m<sup>2</sup> per year; backup fuel: Natural gas.

**TABLE C.6****CAPEX Cost Estimate of Typical SWRO Plant 100,000 m<sup>3</sup>/d Comprising Pretreatment of FF1**

SWRO plant net capacity	100,000	m <sup>3</sup> /day
Type of pretreatment	FF1	Gravity filters
Type of potabilization	Lime/CO <sub>2</sub>	
Waste water treatment	y	Y/n
Type of intake	Open	
Plant lifetime	25	Years
Interest rate	6	%/year

Systems	System cost (US\$)	Cost partitions %	Specific cost US\$/m <sup>3</sup> ,day	Remarks
Intake, pump station, and outfall	30,000,000	13.9	300.0	
Pretreatment System	25,000,000	11.6	250.0	
Membranes (in case MF/UF)	—	—	—	
Pretreatment without membranes	25,000,000	11.6	250.0	
Reverse osmosis part total	80,000,000	37.2	800.0	Isobaric ERD
Membranes (without vessels)	8,000,000	3.7	80.0	
Reverse osmosis without membranes	72,000,000	33.4	720.0	
Potabilisation Plant	10,000,000	4.6	100.0	
Drinking water storage and pumping	10,000,000	4.6	100.0	
Wastewater collection and treatment	5,000,000	2.3	50.0	
Mechanical equipment without membranes	152,000,000	70.6	1,520.0	
Auxiliary systems	7,000,000	3.3	70.0	
Civil works	16,000,000	7.4	160.0	
Electrical works	15,000,000	7.0	150.0	
I & C works	7,000,000	3.3	70.0	
Total	205,000,000		2,050.0	
Contingencies (%)	5	10,250,000	4.8	102.5
SWRO plant total <sup>a</sup>	215,250,000	100.0	2,152.5	
Annual capital cost (annuity)	US\$/year 16,838,301		US\$/m <sup>3</sup> ,day 0.46	

Source: Fichtner and DLR 2011.

a. Cost including engineering, project management, construction, testing, construction site works, and supervision, construction, and testing.

TABLE C.7

**OPEX Cost Estimation of Typical MED Plant**

MED plant net capacity	100,000	m <sup>3</sup> /day
Type of potabilization	Lime/CO <sub>2</sub>	
Specific Capex cost MED	1,800	US\$/m <sup>3</sup> , day
Steam and condensation system	4	% of MED CAPEX
Erection, commissioning, and testing	10	% of MED CAPEX
Civil works MED	5	% of MED CAPEX
Plant lifetime	25	Years
Interest rate	6	%/year

Systems	System cost US\$	Cost partitions %	Specific cost US\$/m <sup>3</sup> , day	Remarks
Intake, pump station, and outfall including civil	50,000,000	15.9	500.0	
Seawater chlorination	2,000,000	0.6	20.0	
MED				
Process including electrical and I & C	180,000,000	57.4	1,800.0	
Steam supply and condensate return	7,200,000	2.3	72.0	
Erection, commissioning, and testing	18,000,000	5.7	180.0	
MED total	205,000,000	65.4	2,052.0	
Potabilisation plant	10,000,000	3.2	100.0	
Drinking water storage and pumping	10,000,000	3.2	100.0	
Mechanical equipment total	284,400,000	90.7	2,844.0	
Auxiliary systems <sup>a</sup>	5,000,000	1.6	50.0	
Civil works				
Of MED process	9,000,000	2.9	90.0	
Infrastructure <sup>a</sup>	3,000,000	1.0	30.0	
Civil works total	12,000,000	3.8	120.0	
Electrical works excluding MED <sup>a</sup>	3,000,000	1.0	30.0	
I & C works excluding MED <sup>a</sup>	1,500,000	0.5	15.0	
Total	298,700,000		2,987.0	
Contingencies (%)	5	14,935,000	4.8	149.5
MED plant total <sup>a</sup>	313,635,000	100.0	3,136.4	
Annual capital cost (annuity)	US\$/year 24,534,637		US\$/m <sup>3</sup> 0.67	

Source: Fichtner and DLR 2011.

a. Share of works in overall solar water/power plant. Cost including engineering, project management, construction, testing, construction site works, and supervision, construction, and testing.

## Notes

1. Steam cost is usually dependent on fuel type, unit fuel cost, boiler efficiency, feedwater temperature, and steam pressure.
2. In the Solar Only scenario, no cogeneration of power and water is assumed. Instead, a SWRO plant with RE energy supply supplemented with grid-supplied electricity is assumed. The other three scenarios analyzed in tables C.4 and C.5 assume local production of necessary power to supply desalination plants.

## Reference

Fichtner (Fichtner GmbH & Co. KG) and DLR (Deutsches Zentrum für Luft- und Raumfahrt e.V.). 2011. *MENA Regional Water Outlook, Part II, Desalination Using Renewable Energy, Task 1–Desalination Potential; Task 2–Energy Requirements; Task 3–Concentrate Management*. Fichtner and DLR. [http://www.dlr.de/tt/Portaldata/41/Resources/dokumente/institut/system/projects/MENA\\_REGIONAL\\_WATER\\_OUTLOOK.pdf](http://www.dlr.de/tt/Portaldata/41/Resources/dokumente/institut/system/projects/MENA_REGIONAL_WATER_OUTLOOK.pdf).



## Summary of Renewable Energy Policies and Legislation in MENA

- A. MENA countries can be clustered into four main categories regarding their energy policies and legislation:
  1. Countries that have neither set a target for the promotion of renewable energy (RE) sources nor introduced a RE policy or legislation
  2. Countries that, to some extent, have set a target for renewable energy but have not yet focused on introducing RE policies
  3. Countries that have set a target for renewable energy and are drafting an RE law
  4. Countries that have set a target for renewable energy and have established a RE policy and binding legislation.
- B. Djibouti, Iraq, and Oman are included in the first category. Although they have set no energy targets, some category 1 countries, such as Oman, have initiated steps to promote renewable energy. Oman implements small-scale RE projects within the existing framework.
- C. The second category applies primarily to the Gulf Cooperation Council (GCC) countries. Even though most of these countries have set their targets for renewable energy promotion, their targets often are rather low, for example, 5–10 percent by 2020. Furthermore, this group does not have nationally binding RE legislation and a clear and consistent national policy framework for renewable energies and energy efficiencies. Rather, category 2 countries often focus on specific projects. Examples are the United Arab Emirate’s Masdar City Project and the Qatar National Foundation. Both aim to foster the development and promotion of sustainable energy sources using a project-based approach.
- D. The third category includes Libya, the Syrian Arab Republic, and the Republic of Yemen. These countries have set themselves rather ambitious targets of the percentage of renewable energy power in their

energy mix and have started to work on a new energy law to foster the use and deployment of RE sources. However, the policies and draft legislation of these countries often are not yet as comprehensive and far-reaching as those of the countries that already have enacted a binding and enforceable law, because the former rarely contain provisions on financial mechanisms such as feed-in tariffs or other incentives.

- E. Contrary to the GCC countries,<sup>1</sup> most category 4 countries, including most of the North African countries, have set ambitious targets to deploy renewable energies and have introduced new energy legislation that promotes the generation of electricity from RE sources. With 42 percent RE mix in its national energy portfolio, Morocco has the most ambitious plan in MENA. Algeria also has a comprehensive and far-reaching energy policy, because—with Israel—it is the only MENA country that incentivizes the deployment of renewable energies via feed-in tariffs. Other category 4 country legislation, such as that of the Arab Republic of Egypt, Jordan, Morocco, and Tunisia, contain various supportive incentives, for example, public competitive bidding, tax reductions, or dispatching priority. The framework conditions in Algeria, Morocco, and Tunisia also serve the implementation of reference projects of the DESERTEC Initiative.
- F. On a regional level, the GCC Supreme Council, which has the objective to highlight the importance of joint environmental policies and laws, also deserves mention. Its achievements include the GCC common power grid, which is being established, and the US\$750 million fund for projects related to the prevention of climate change (Reiche 2010, 6).
- G. Table D.1 gives an overview of the existence of renewable energy legislation in MENA, the targets that have been set by MENA countries, the dates by which these targets are to be achieved, as well as specific policy features that foster additional investments in generating RE.



TABLE D.1

## Status of Renewable Energy Policies and Legislation in MENA

Country	Legislation to promote RE in place (Y/N)	Target of RE mix and date to be achieved (% of overall energy sources)	Specific policy features/financial incentives to use RE
<b>Algeria</b>	Y <sup>2</sup>	6% by 2015 20% by 2030	<ul style="list-style-type: none"> <li>• Feed-in tariff:               <ul style="list-style-type: none"> <li>◦ Premiums are granted for electricity produced by RE sources</li> <li>◦ Premium depends on specific RE source and on wholesale market price for electricity</li> </ul> </li> <li>• Tax reduction/credits</li> <li>• National Fund for Energy Management</li> <li>• Liberalization of electricity and gas sectors</li> <li>• Establishment of monitoring body</li> <li>• Reference DESERTEC Initiative solar energy project in preparation</li> </ul>
<b>Bahrain</b>	N <sup>3</sup>	5% by 2020	<ul style="list-style-type: none"> <li>• Planned projects:               <ul style="list-style-type: none"> <li>◦ First wind farm (likely to be put out to tender as an independent power project, or IPP)</li> <li>◦ Waste-to-energy PPP plant (on a build-operate-transfer [BOT] basis)</li> <li>◦ Photovoltaic power plant (US\$200 million)</li> </ul> </li> </ul>
<b>Djibouti</b>	N	N/A	<ul style="list-style-type: none"> <li>• N/A</li> </ul>
<b>Egypt, Arab Rep.</b>	Y <sup>4</sup>	Renewable Energy Policy of 2010  20% by 2020	<ul style="list-style-type: none"> <li>• New Energy Policy aims to:               <ul style="list-style-type: none"> <li>◦ Introduce competitive environment (unbundling production, transmission, and distribution activities)</li> <li>◦ Create favorable conditions to achieve RE goal</li> </ul> </li> <li>• In place:               <ul style="list-style-type: none"> <li>◦ Exemption from, or reduction of, custom duties, sales, VAT, energy, CO<sub>2</sub>, other taxes</li> <li>◦ Public competitive bidding</li> <li>◦ Public investments, loans, or grants</li> <li>◦ Capital subsidy, grant, or rebate</li> <li>◦ Fund for Development of Power Generation from Renewable Energies<sup>5</sup></li> </ul> </li> <li>• Features of new draft Electricity Law:               <ul style="list-style-type: none"> <li>◦ Establishes liberalized electricity market.</li> <li>◦ Articles 20–22 address replacement of current Single Buyer Model and enables third-party access to electricity grid. Access to electricity grids will be based on published tariffs and long-term electricity purchase agreements.</li> <li>◦ Government plans to remove all energy subsidies by 2017.</li> <li>◦ Law foresees that private sector builds, owns, and operates (BOO) RE electricity generation projects and sells electricity to transmission company under long-term power purchase agreements (PPA). Nonrenewable-energy-based independent power producers (IPPs) conclude bilateral purchase agreements with eligible consumers.<sup>6</sup></li> </ul> </li> <li>• Energy subsidy policy changed:               <ul style="list-style-type: none"> <li>◦ Energy subsidies gradually are being reduced.</li> </ul> </li> </ul>

*(Table continues next page)*

TABLE D.1

*continued*

Country	Legislation to promote RE in place (Y/N)	Target of RE mix and date to be achieved (% of overall energy sources)	Specific policy features/financial incentives to use RE
<b>Gaza/West Bank</b>	N (New electricity law in 2009) <sup>7</sup>	N/A	<ul style="list-style-type: none"> <li>○ RE only mentioned in electricity law</li> <li>○ No feed-in tariff</li> <li>○ No third-party access</li> <li>• Planned projects: <ul style="list-style-type: none"> <li>○ Several RE projects planned</li> <li>○ EU “Solar for Peace” program on hold</li> </ul> </li> </ul>
<b>Iran, Islamic Rep.</b>	N <sup>8</sup>	N/A	<ul style="list-style-type: none"> <li>• Fiscal incentives<sup>9</sup>: <ul style="list-style-type: none"> <li>○ Investment or production tax credit</li> <li>○ Energy production payment</li> </ul> </li> </ul>
<b>Iraq</b>	N <sup>10</sup>	N/A	N/A
<b>Israel</b>	Y <sup>11</sup>	5% by 2016 10% by 2020	<ul style="list-style-type: none"> <li>• Financial mechanisms: <ul style="list-style-type: none"> <li>○ Feed-in tariff (including premium payment): in effect for lesser of 15 years from RE generator’s construction date or duration of renewable generator’s license</li> <li>○ Heat obligation/mandate</li> <li>○ Facilitation of land availability</li> <li>○ Investment grants</li> <li>○ Reduction in sales, energy, CO<sub>2</sub>, VAT, or other tax cuts</li> <li>○ Public competitive bidding<sup>12</sup></li> </ul> </li> <li>• Planned projects: <ul style="list-style-type: none"> <li>○ Multiple CSP and PV projects in conceptual stage</li> <li>○ In 2008 USDOE and Israeli Ministry of National Infrastructures signed MoU concerning cooperation on renewable and sustainable energy.<sup>13</sup></li> </ul> </li> </ul>
<b>Jordan</b>	Y <sup>14</sup> General Electricity Law 2003  Renewable Energy and Energy Efficiency Law (REEE Law 3/2010)  Jordanian Law No. 16 (Investment Promotion Law)	Long-Term Development Plan, 2004 National Energy Strategy 2007–20  7% by 2015 10% by 2020	<ul style="list-style-type: none"> <li>○ Net metering</li> <li>○ Reduction in sales, energy, CO<sub>2</sub>, VAT, other taxes</li> <li>○ Public competitive bidding</li> <li>○ Dispatching priority given to RE (priority for feed-in to national grid and purchase obligation)</li> <li>○ Permission for investors to present voluntary proposals for grid-connected RE investments.</li> <li>○ Establishment of a Renewable Energy and Energy Efficiency Fund for RE projects<sup>15</sup></li> <li>○ Investment Promotion Law offers concessions for investors in RE projects, such as exemption of installation components or spare parts from custom duties, charges, and taxes. Depending on site, concessions of 25%–75% may apply on income tax or social services.<sup>16</sup></li> </ul>

<b>Kuwait</b>	N (Energy sector reform being discussed, including unbundling option and privatization of electricity market. No RE law exists. <sup>17</sup> )	5% by 2020	N/A
<b>Lebanon</b>	N	12% by 2020 (based on Beirut Declaration on the Mediterranean Solar Plan)	N/A
<b>Libya</b>	N <sup>18</sup> (Only draft electricity legislation in place; similar to Egyptian law)	RE roadmap to 2030 by Renewable Energy Authority of Libya (REAOL): REAOL was established by law 426 in 2007:  6% by 2015 10% by 2020 25% by 2025 30% by 2030	<ul style="list-style-type: none"> <li>o REAOL has been provided with US\$487 million of funding to 2012.</li> <li>o State-owned electricity company General Electricity Company (GECOL) is responsible for power generation, transmission, and distribution. Unbundling GECOL and liberalization was discussed but not realized so far.</li> <li>o Libyan <i>Five Points Company for Construction and Touristic Investment</i> has announced concluding a contract with Gulf Finance House to build an "Intelligent Energy City" in Libya (US\$5 billion).</li> <li>o New energy efficiency law in preparation</li> <li>o No financial incentives in place to promote RE<sup>19</sup></li> </ul>
<b>Morocco</b>	Y <sup>20</sup> (According to new August 2011 energy strategy, new legislation will be put in place.)	Moroccan National Program for Development of Renewable Energies and Energy Efficiency (PNDEREE), 2010 <sup>21</sup> : <ul style="list-style-type: none"> <li>o 20% by 2012</li> <li>o 42% by 2020</li> <li>o (Target of 2000 MW for solar power)</li> </ul>	<ul style="list-style-type: none"> <li>• Specific features of <i>Loi N° 13-09</i>: <ul style="list-style-type: none"> <li>o Open competition to produce electricity from RE sources</li> <li>o Third-party access to national energy grid (access to medium, high voltage, and very high voltage national electricity grid to any power producer of RE sources and right-to-use interconnections—subject to technical capacity and authorization of grid operator)</li> <li>o Possibility to export electricity produced from RE sources</li> <li>o Right to build direct transport lines in case of incapacities of national electricity grid or transport interconnections</li> <li>o Permission to produce electricity from RE sources provided for 25 years</li> </ul> </li> <li>• Not yet applicable in Morocco according to law: <ul style="list-style-type: none"> <li>o No specific price incentives yet in place for renewable energies, for example, no (fixed) feed-in tariffs, but encouraged by DESERTEC consortium to foster Trans- European-MENA grid</li> <li>o First reference CSP power plant project started by DESERTEC Initiative</li> <li>o Authorization of private RE producers to export electricity through national grid and to implement dedicated high voltage direct current lines, if necessary.</li> <li>o Public investment, loans, or grants<sup>22</sup></li> </ul> </li> </ul>

(Table continues next page)

TABLE D.1

*continued*

Country	Legislation to promote RE in place (Y/N)	Target of RE mix and date to be achieved (% of overall energy sources)	Specific policy features/financial incentives to use RE
<b>Oman</b>	N <sup>23</sup> (Sector law: Royal Decree 78/2004 governing restructuring of energy sector, privatization, and regulation by establishing Authority for Electricity Regulation)	In 2008, Authority for Electricity Regulation published a Study on RE Sources recommending: <ul style="list-style-type: none"> <li>Implementation of small-scale RE project within existing statutory framework</li> <li>Large-scale projects will need additional research and policy amendments (quotas and feed-in tariffs)</li> </ul>	<ul style="list-style-type: none"> <li>Licensing regime subject to “appropriate person criteria”</li> <li>Government stated its support for RE initiatives</li> <li>Ministerial committee established to coordinate efforts</li> <li>Technical committee formed</li> <li>Public Authority for Electricity and Water (PAEW) taking steps to implement RE projects and to identify need for policy measures.</li> <li>The Authority for Electricity Regulation involved with PAEW in proposing further changes in the current sector law to promote competition, define subsidies and tariffs for large-scale renewable energy projects.</li> </ul>
<b>Qatar</b>	N	Qatari National Vision 2030:  According to Vision, an additional 3,500 MW of solar energy will be provided to the grid by 2013. <sup>24</sup>	<ul style="list-style-type: none"> <li>Qatar National Vision 2030 outlines sustainable economic development (3d pillar) by means of private sector involvement and financial and nonfinancial support mechanisms as well as environmental development (4th pillar). Vision’s focus is negative impacts of climate change and mitigating them by establishing a comprehensive legal system and environmental institutions that promote use of environmentally sound technologies.</li> <li>The Qatar National Food Security Program (QNFSP) aims to utilize clean energy sources and carbon reduction schemes to enable sustainable and environmentally friendly operation; promotes local RE demand; supports National Vision 2030 by aiming “to reduce the country’s economic dependency on hydro-carbon resources, develop environmental sustainability, and create a knowledge-based society.”<sup>25</sup></li> </ul>
<b>Saudi Arabia</b>	N	10% by 2020 20% by 2030	<ul style="list-style-type: none"> <li><i>Soleras</i> (Solar Energy Research American Saudi): provision of solar energy to 2 KSA villages not connected to electricity grid</li> <li>Very recently Saudi Arabia announced a program to develop about 54 GW of electricity from renewables by 2032, including about 41 GW from Solar alone.</li> </ul>
<b>Syrian Arab Rep.</b>	N (Draft legislation in place only)	7.5% by 2020 6,000 MW by 2030	<ul style="list-style-type: none"> <li>Draft energy legislation consists of: <ul style="list-style-type: none"> <li>Participation of private sector in generating energy and operating distribution network</li> <li>Establishment of a regulatory agency</li> <li>Measures to promote RE use</li> <li>Restructuring energy sector<sup>26</sup></li> </ul> </li> </ul>

<b>Tunisia</b>	Y <sup>27</sup>  Law No. 2004-72, modified by Law No. 2009-7 Fixed decree 2009-362	4% by 2012 10% by 2014 40 RE projects for implementation (2010–16)	<ul style="list-style-type: none"> <li>• Article 14 of <i>Law No. 2004-72</i> mentions 4 areas for RE promotion<sup>28</sup>:               <ul style="list-style-type: none"> <li>◦ Expand wind power</li> <li>◦ Introduce incentives to use solar thermal energy</li> <li>◦ Use solar energy for electrification of rural areas, irrigation, and seawater desalination</li> <li>◦ Promote greater use of production of RE</li> </ul> </li> <li>• Specific mechanisms to promote RE:               <ul style="list-style-type: none"> <li>◦ Direct financial incentives, such as capital subsidy, grant, or rebates</li> <li>◦ Tax incentives, such as reduction of custom duties in sales, energy, CO<sub>2</sub>, exemption from VAT for locally manufactured raw materials or equipment, or other taxes</li> <li>◦ Public investment, loans, or grants<sup>29</sup></li> <li>◦ Reference solar energy project of DESERTEC Initiative in preparation</li> </ul> </li> <li>• Not yet applicable in Tunisia according to law:               <ul style="list-style-type: none"> <li>◦ Renewable portfolio, such as quota schemes</li> <li>◦ Public competitive bidding for fixed RE capacity</li> <li>◦ Tax credits</li> <li>◦ Net metering</li> <li>◦ Tradable RE certificates</li> </ul> </li> </ul>
<b>United Arab Emirates</b>	N <sup>30</sup>	7% by 2020	<ul style="list-style-type: none"> <li>◦ Masdar City Project</li> <li>◦ Masdar Clean Technology Fund of US\$250 million finances RE research projects undertaken by private sector.<sup>31</sup></li> </ul>
<b>Yemen, Rep.</b>	N (Electricity Law No. 1 of 2009 only generally supports RE by stating that task of ministry is “encouraging and developing the use of RE resources in the generation of electrical power”; law sets up Rural Electrification Authority and provides for commercialization of Public Electricity Corporation and separation of entities for generation, distribution, transmission, and rural electrification.) <sup>33</sup>	National Power Sector Strategy for RE and Energy Efficiency:  15–20% by 2025	<ul style="list-style-type: none"> <li>• Power sector reform aims to eliminate subsidies for conventional energy sources.</li> <li>• New draft legislation of the electricity law could include:               <ul style="list-style-type: none"> <li>◦ Creation of registry of RE locations</li> <li>◦ Creation of RE source certificates</li> <li>◦ Duty of public electricity system to purchase electricity from specific RE generation sites</li> <li>◦ Permission of funds for subsidies for renewable energies.<sup>32</sup></li> </ul> </li> </ul>

## Notes

1. Saudi Arabia recently announced a plan to add about 54 gigawatts of renewable energy to its energy mix by 2072. About 41 gigawatts of this is from solar.
2. The main legislations in Algeria are The *Law No. 99-09 of July 28, 1999* on energy control, which provides for renewable energy to be financed from the National Fund; *Act No. 04-09 of August 14, 2004* on the promotion of renewable energy within a framework of sustainable development; *Act No. 02-01 of February 5, 2002* on electricity and distribution of gas; within this law, the following *décret* has been issued: *Décret exécutif No. 04-92 du 4 Safar 1425 correspondant au 25 mars 2004 relatif aux coûts de diversification de la production d'électricité*. See RCREEE 2010. "Provision of Technical Support/Services for an Economical Technological and Environmental Impact Assessment of National Regulations and Incentives for Renewable Energy and Energy Efficiency: Desk Study Algeria," 19. [http://www.rcreee.org/Studies/Danida\\_Country\\_Studies/Desk\\_Study\\_Algeria\\_EN.pdf](http://www.rcreee.org/Studies/Danida_Country_Studies/Desk_Study_Algeria_EN.pdf).
3. Bahrain has signed the statute for the International Renewable Energy Agency (IRENA). In 2005 the Electricity and Water Authority established a solar and wind energy committee. In 2009 a consultation committee was set up for a solar and wind hybrid pilot project with a capacity of 3–5 MW. <http://www.nortonrose.com/knowledge/publications/33679/renewable-energy-in-bahrain>.
4. In March 2010, the Supreme Energy Council approved key policy steps related to scaling up wind and CSP. These steps include approval of the need to cover additional costs for RE projects through tariffs, approval of zero customs duty on wind and CSP equipment, finalization of the land use policy for wind and CSP developers, acceptance of foreign-currency-denominated power purchase agreements (PPAs), and confirmation of central bank guarantees for all build-own-operate (BOO) projects, permitting support for developers with respect to environmental, social, and defense permits.
5. REN 21 2011, 54.
6. [https://energypedia.info/index.php/Egypt\\_Energy\\_Situation#cite\\_note-18](https://energypedia.info/index.php/Egypt_Energy_Situation#cite_note-18).
7. EIB 2010, 72.
8. The Law of the Fifth Five-Year Development Plan of the I.R.I (2011–2015, ratified Jan. 5, 2011) promotes "clean energy," but thereby refers to nuclear energy only. See Mostofi and Ahanrobay.
9. REN 21 2011, 53.
10. In 2010 Iraq signed Memorandum of Understanding (MoU) with European Union on strategic partnership in energy. One area of cooperation is the preparation of an action plan to develop renewable energies in Iraq. IP 10/29, 18 January 2010.
11. Israel *Electricity Sector Law 5756-1996*. <http://www.mni.gov.il/mni/en-US/Energy/Laws/ElectricityMarketLaw.htm>; *Energy Sources Law 5750-1989*, in *Sefer Habukim* (Statutes of the State of Israel) 5750, 28.
12. REN 21 2011, 52; EIB 2010, 77.
13. Israel 2008. In 2008, Israel and the US entered into an MoU to cooperate on renewable and sustainable energy and the development of energy-efficiency-related technologies.
14. Jordan is one of the first countries in the region to initiate reforms in the electricity sector, and the government is taking steps to establish a favorable

- policy framework. In February 2010, a Renewable Energy and Energy Efficiency Law (REEE Law 3/2010) was ratified, which supports the deployment of RE. Currently, the government is preparing a RE transaction strategy that is expected to be approved by the cabinet by the end of the year.
15. REN 21 2011, 54; EIB 2010, 81.
  16. Energypedia, [https://energypedia.info/index.php/Jordan\\_Energy\\_Situation](https://energypedia.info/index.php/Jordan_Energy_Situation).
  17. REEEP 2010a.
  18. REEEP 2010b. Libya has no legislation on financial support for RE, nor any clear legislative basis for the participation of private capital in the power sector. Currently, no drafts of the electricity law exist. Furthermore, Libya has no energy efficiency law in place. The current National Mid-Term Plan covers 2008–12.
  19. RCREEE 2010.
  20. Royaume du Maroc. *Loi N° 13-09 de 13ième janvier 2010 relative aux énergies renouvelables*, <http://www.mem.gov.ma/Documentation/pdf/Loi%20ADEREE/Loi%20ADEREE.pdf>; *Loi N° 16-09 de 13ième janvier 2010 à l'Agence nationale pour le développement des énergies renouvelables et de l'efficacité énergétique*, <http://www.mem.gov.ma/Documentation/pdf/loi%20Energies%20renouvelables/loi%20Energies%20renouvelables.pdf>; *Loi N° 57-09 de 14ième janvier 2010 portant creation de la Société "Moroccan Agency for Solar Energy."* <http://www.mem.gov.ma/Documentation/pdf/loiMASEN/Loi%20MASEN.pdf>.
  21. Royaume du Maroc, Ministère de l'Energie, de l'Eau et de l'Environnement. *"La Nouvelle Stratégie Énergétique Nationale," mise à jour septembre 2010.* <http://www.mem.gov.ma/Documentation/LA%20NOUVELLE%20STRATEGIE%20ENERGETIQUE%20NATIONALE.pdf>; "Key Achievements (1999–2009)." <http://www.mem.gov.ma/Documentation/pdf/PrincipalesRealisations.pdf>; to meet its target of 20% in renewable energy sources by 2012 and 42% by 2020, structural reforms of the legal system have been identified in the New Energy Strategy that address the issues of security of supply, cost-effective access to energy, diversification of energy supply sources, development of national energy sources, and promotion of energy efficiency (MEM Oct. 2008); Aquamarine Power/ProDes, 81ff.
  22. REN 21 2011, 54; EIB 2010, 92ff.
  23. Sultanate of Oman.
  24. Jones/Molan/Vinson and Elkins LLP, "Chapter 27: Renewable Energy," 306ff. In *Investing in the GCC: New Opportunities in a Changing Landscape*, March 2010; General Secretariat for Development Planning. "Qatar National Vision 2030." [http://www.qu.edu.qa/pharmacy/components/upcoming\\_events\\_material/Qatar\\_National\\_Vision\\_2030.pdf](http://www.qu.edu.qa/pharmacy/components/upcoming_events_material/Qatar_National_Vision_2030.pdf).
  25. QNFSP (Qatar National Food Security Program). <http://www.qnfs.gov.qa/programme/renewable-energy>.
  26. EIB 2010, 101.
  27. The Tunisian Solar Plan (TSP) was launched in December 2009 for 2010–16 to increase the share of RE and energy efficiency.
  28. *La loi No. 2004-72 du 02 aout 2004 relative a la maitrise de d'energie.* [http://www.aes-tunisie.com/userfiles/file/loi%20n%C2%B02004\\_72.pdf](http://www.aes-tunisie.com/userfiles/file/loi%20n%C2%B02004_72.pdf).
  29. REN 21 2011, 54.
  30. According to the Plan Abu Dhabi 2030: Urban Structure Framework Plan (<http://gsec.abudhabi.ae/Sites/GSEC/Navigation/EN/publications>,

- did=90378.html) and the policy framework of the government, the *Masdar Initiative* is a key element to foster the development, commercialization, and deployment of renewable and alternative energy technologies in the United Arab Emirates. Moreover, the *Green Dubai Initiative* also focuses on reducing the carbon emissions footprint of the United Arab Emirates. See Country Profile: United Arab Emirates. <http://www.reegle.info/countries/AE>.
31. REEGLE. "Country Energy Profile: United Arab Emirates." <http://www.reegle.info/countries/AE>.
  32. The country's new *Electricity Law No. 1 of 2009* aims to ensure the electricity generation security. The law includes provisions for the development of new power systems, improving the quality of electrical services, and encouraging local and foreign private investments in the sector. *Law No. 3 of 2009* was issued to settle a loan agreement signed between the Republic of Yemen and the *Islamic Tadamon Fund for Development*, totaling US\$11.2 million. <http://www.yobserver.com/local-news/10015931.html>.
  - RCREEE. 2010. "Provision of Technical Support/Services for an Economical, Technological and Environmental Impact Assessment of National Regulations and Incentives for Renewable Energy and Energy Efficiency: Country Report Yemen," 16ff. [http://www.rcreee.org/Studies/Danida\\_Country\\_Studies/Yemen.pdf](http://www.rcreee.org/Studies/Danida_Country_Studies/Yemen.pdf).
  33. RCREEE 2010. "Provision of Technical Support/Services for an Economical, Technological and Environmental Impact Assessment of National Regulations and Incentives for Renewable Energy and Energy Efficiency: Country Report Yemen," 17ff. [http://www.rcreee.org/Studies/Danida\\_Country\\_Studies/Yemen.pdf](http://www.rcreee.org/Studies/Danida_Country_Studies/Yemen.pdf).

## Reference

- Reiche, D. 2010. "Energy Policies of Gulf Cooperation Council (GCC) Countries—Possibilities and Limitations of Ecological Modernization in Rentier States." *Energy Policy* 38 (5), 2395–403.





## ECO-AUDIT

### *Environmental Benefits Statement*

The World Bank is committed to preserving endangered forests and natural resources. The Office of the Publisher has chosen to print the *Renewable Energy Desalination* on recycled paper with 30 percent post-consumer fiber in accordance with the recommended standards for paper usage set by the Green Press Initiative, a nonprofit program supporting publishers in using fiber that is not sourced from endangered forests. For more information, visit [www.greenpressinitiative.org](http://www.greenpressinitiative.org).

#### Saved:

- 13 trees
- 5 million Btu of total energy
- 1,239 lb. of net greenhouse gases
- 5,588 gal. of waste water
- 355 lb. of solid waste



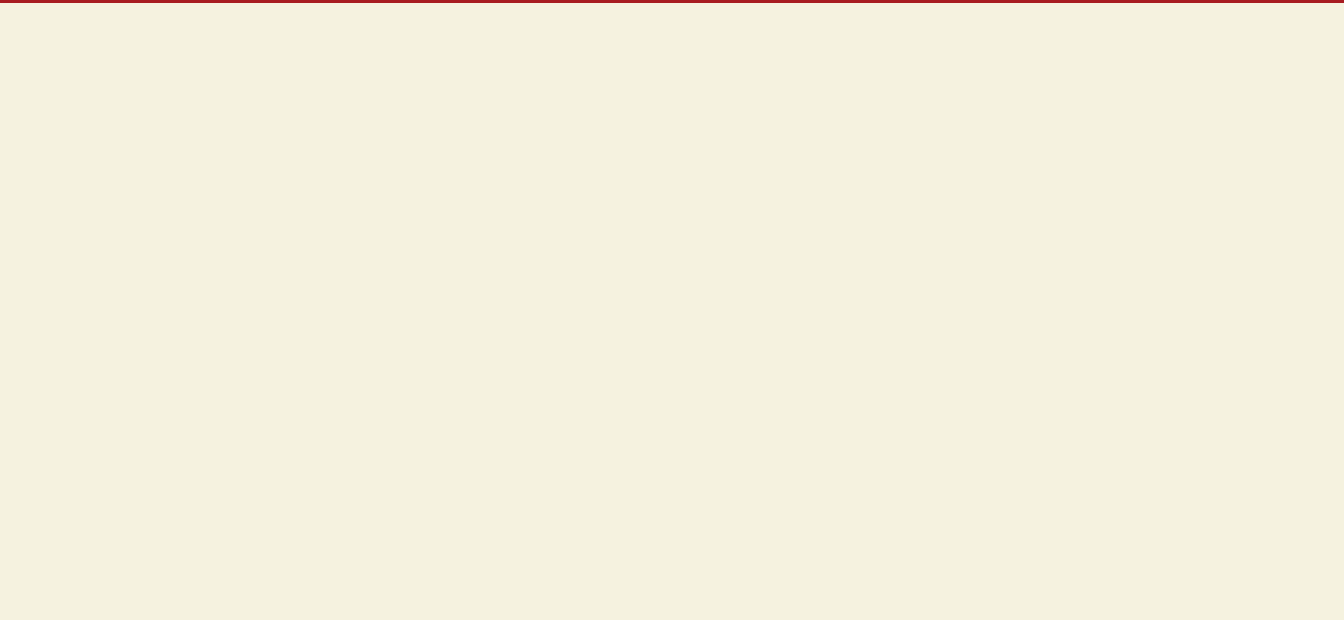

The Middle East and North Africa (MENA) region is one of the most water stressed areas in the world. Already today water scarcity represents a challenge to the economic development and social well-being of many countries in the region. With projected increases in population and likely changes in weather patterns due to climate change impacts, MENA's annual water demand gap is expected to grow five-fold over the next 40 years, from today's 42 cubic kilometers to 200 cubic kilometers by 2050.

In face of extreme scarcity, water management in the region is weak, with inefficiencies throughout the agriculture, municipal, and industrial sectors and many utilities already financially unsustainable. As a result, countries overexploit their fossil aquifers and use conventional energy-based desalination to meet the water gap—a very costly and unsustainable approach. Desalination already plays, and will continue to play, a critical role in the region's water supply portfolio, but only through harnessing new technologies that can lower costs and environmental impacts. Based on current trends, by 2050 Saudi Arabia and many other oil-producing countries in the region will use most of their oil production for desalination as well as for domestic energy consumption. At the same time, overexploitation of fossil aquifers is reaching its limit in many countries in the region. New solutions need to come into play.

This book offers an overview of the water and energy challenges the region faces, analyzing the scope of alternative options for addressing the growing water gap. Estimates of the region's water gap today and into the future are offered, along with a methodology for prioritizing the options to bridge the water gap using the "marginal cost of water" approach. The book also assesses the viability of renewable energy desalination as an important option for closing the water gap and compares the economic cost of desalination using fossil fuel and renewable energy sources, in particular Concentrated Solar Power (CSP). The book also highlights the environmental implications of desalination. Finally, the book provides recommendations as to how CSP-based desalination could ensure sustainable water supply for the region.

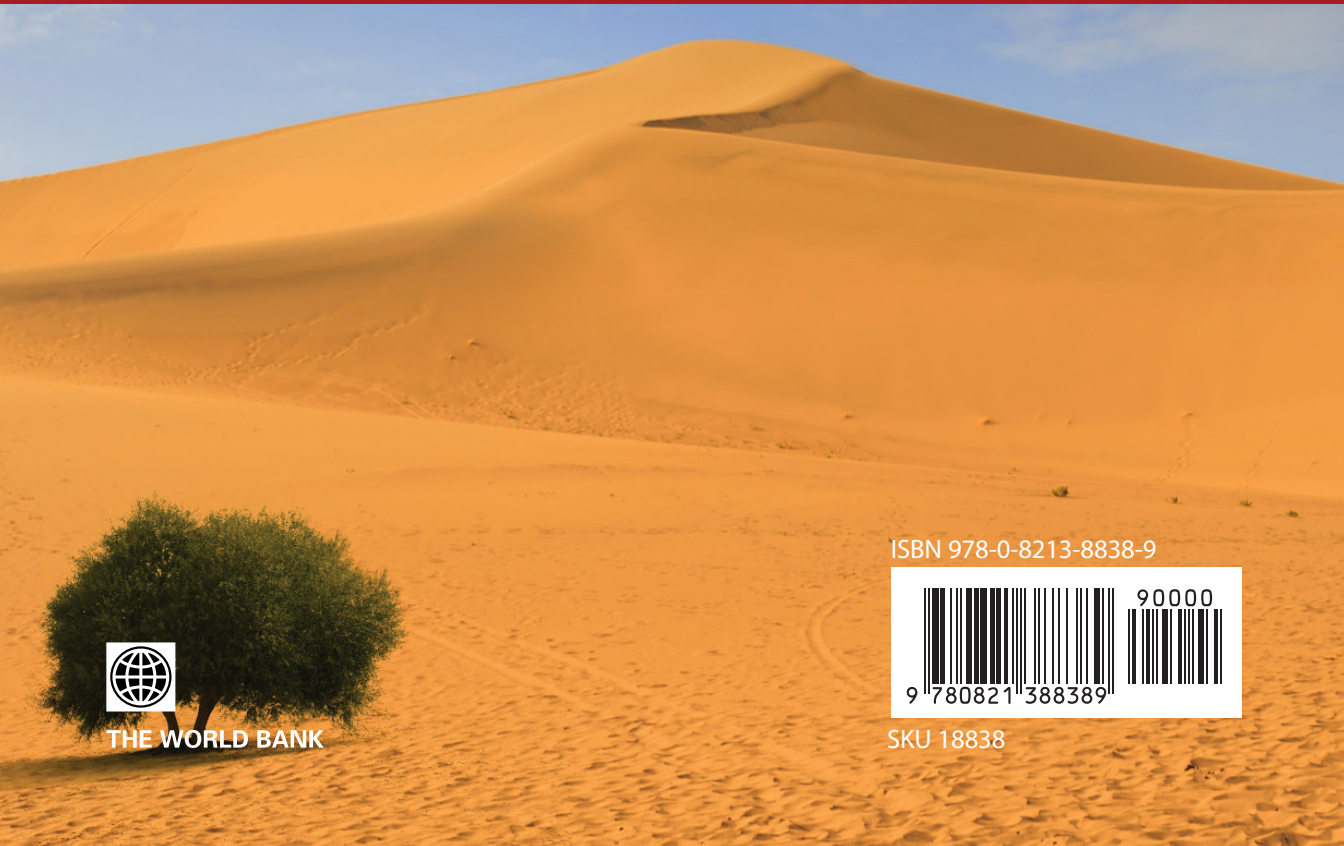

THE WORLD BANK

ISBN 978-0-8213-8838-9



SKU 18838